

[查询"MRF422MP"供应商](#)

The RF Line

NPN Silicon RF Power Transistor

Designed primarily for applications as a high-power linear amplifier from 2.0 to 30 MHz.

- Specified 28 Volt, 30 MHz Characteristics —
Output Power = 150 W (PEP)
Minimum Gain = 10 dB
Efficiency = 40%
- Intermodulation Distortion @ 150 W (PEP) —
IMD = -30 dB (Min)
- 100% Tested for Load Mismatch at all Phase Angles with 30:1 VSWR

MRF422

**150 W (PEP), 30 MHz
RF POWER
TRANSISTORS
NPN SILICON**

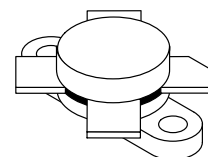

CASE 211-11, STYLE 1

MAXIMUM RATINGS

Rating	Symbol	Value	Unit
Collector-Emitter Voltage	V_{CEO}	40	Vdc
Collector-Base Voltage	V_{CBO}	85	Vdc
Emitter-Base Voltage	V_{EBO}	3.0	Vdc
Collector Current — Continuous	I_C	20	Adc
Withstanding Current — 10 s	—	30	Adc
Total Device Dissipation @ $T_C = 25^\circ\text{C}$ Derate above 25°C	P_D	290 1.66	Watts W/ $^\circ\text{C}$
Storage Temperature Range	T_{stg}	-65 to +150	$^\circ\text{C}$

THERMAL CHARACTERISTICS

Characteristic	Symbol	Max	Unit
Thermal Resistance, Junction to Case	$R_{\theta JC}$	0.6	$^\circ\text{C}/\text{W}$

ELECTRICAL CHARACTERISTICS ($T_C = 25^\circ\text{C}$ unless otherwise noted.)

Characteristic	Symbol	Min	Typ	Max	Unit
----------------	--------	-----	-----	-----	------

OFF CHARACTERISTICS

Collector-Emitter Breakdown Voltage ($I_C = 200 \text{ mAdc}$, $I_B = 0$)	$V_{(BR)CEO}$	35	—	—	Vdc
Collector-Emitter Breakdown Voltage ($I_C = 100 \text{ mAdc}$, $V_{BE} = 0$)	$V_{(BR)CES}$	85	—	—	Vdc
Collector-Base Breakdown Voltage ($I_C = 100 \text{ mAdc}$, $I_E = 0$)	$V_{(BR)CBO}$	85	—	—	Vdc
Emitter-Base Breakdown Voltage ($I_E = 10 \text{ mAdc}$, $I_C = 0$)	$V_{(BR)EBO}$	3.0	—	—	Vdc
Collector Cutoff Current ($V_{CE} = 28 \text{ Vdc}$, $V_{BE} = 0$, $T_C = 25^\circ\text{C}$)	I_{CES}	—	—	20	mAdc

(continued)

ELECTRICAL CHARACTERISTICS — continued ($T_C = 25^\circ\text{C}$ unless otherwise noted.)

Characteristic	Symbol	Min	Typ	Max	Unit
DC Current Gain ($I_C = 5.0 \text{ Adc}$, $V_{CE} = 5.0 \text{ Vdc}$)	h_{FE}	15	30	120	—

DYNAMIC CHARACTERISTICS

Output Capacitance ($V_{CB} = 28 \text{ Vdc}$, $I_E = 0$, $f = 1.0 \text{ MHz}$)	C_{ob}	—	420	—	pF
---	----------	---	-----	---	----

FUNCTIONAL TESTS

Common-Emitter Amplifier Power Gain ($V_{CC} = 28 \text{ Vdc}$, $P_{out} = 150 \text{ W (PEP)}$, $I_{C(max)} = 6.7 \text{ Adc}$, $I_{CQ} = 150 \text{ mA dc}$, $f = 30, 30.001 \text{ MHz}$)	G_{PE}	10	13	—	dB
Collector Efficiency ($V_{CC} = 28 \text{ Vdc}$, $P_{out} = 150 \text{ W (PEP)}$, $I_{C(max)} = 6.7 \text{ Adc}$, $I_{CQ} = 150 \text{ mA dc}$, $f = 30, 30.001 \text{ MHz}$)	η	—	45	—	%
Intermodulation Distortion (1) ($V_{CE} = 28 \text{ Vdc}$, $P_{out} = 150 \text{ W (PEP)}$, $I_C = 6.7 \text{ Adc}$, $I_{CQ} = 150 \text{ mA dc}$, $f = 30, 30.001 \text{ MHz}$)	IMD	—	-33	-30	dB
Output Power ($V_{CE} = 28 \text{ Vdc}$, $f = 30 \text{ MHz}$)	P_{out}	150	—	—	Watts (PEP)

NOTE:

- To Mil-Std-1311 Version A, Test Method 2204, Two Tone, Reference each Tone.

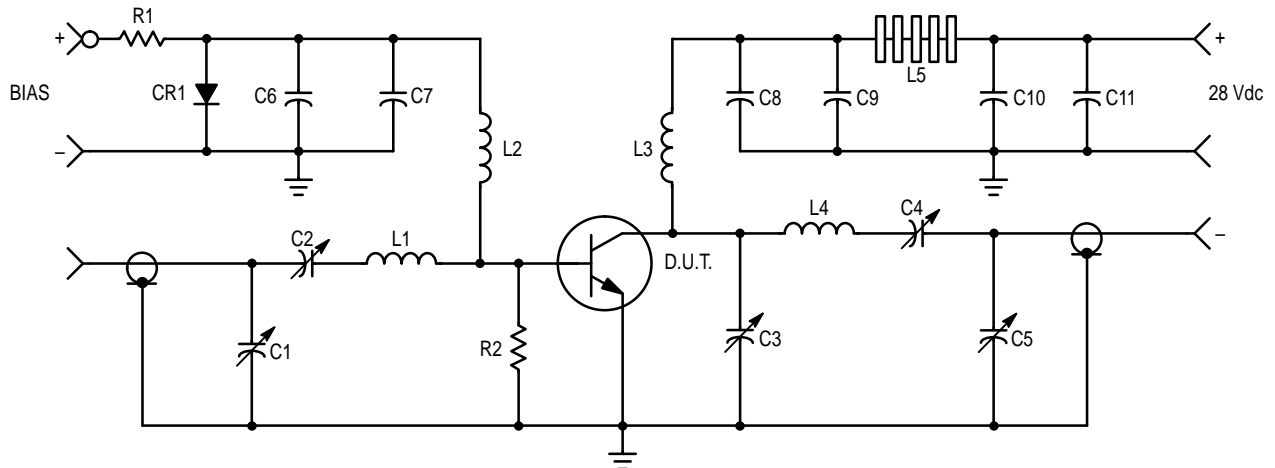

C1, C2, C3, C5 — 170–680 pF, ARCO 469
 C4 — 80–480 pF, ARCO 466
 C6, C8, C11 — ERIE 0.1 μF , 100 V
 C7 — MALLORY 500 μF , 15 V Electrolytic
 C9 — UNDERWOOD 1000 pF, 350 V
 C10 — 10 μF , 50 V Electrolytic
 R1 — 10 Ω , 25 Watt Wire Wound
 R2 — 10 Ω , 1.0 Watt Carbon
 CR1 — 1N4997

L1 — 3 Turns, #16 Wire, 5/16" I.D., 5/16" Long
 L2 — 10 μH Molded Choke
 L3 — 12 Turns, #16 Enameled Wire, Close Wound, 1/4" Dia.
 L4 — 5 Turns, 1/8" Copper Tubing
 L5 — 10 Ferrite Beads — FERROXCUBE #56-590-65/3B

Figure 1. 30 MHz Test Circuit Schematic

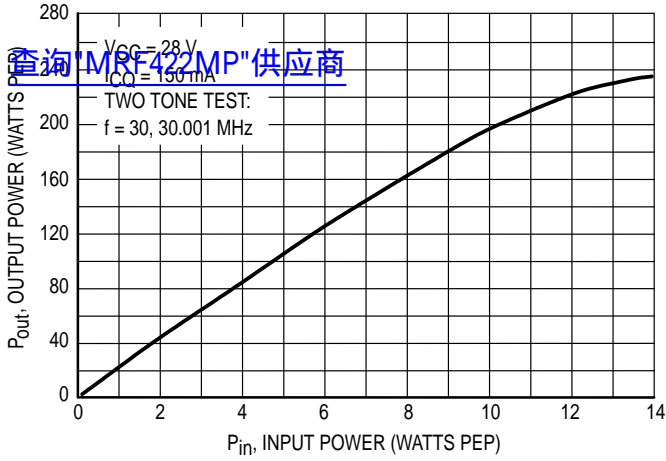

Figure 2. Output Power versus Input Power

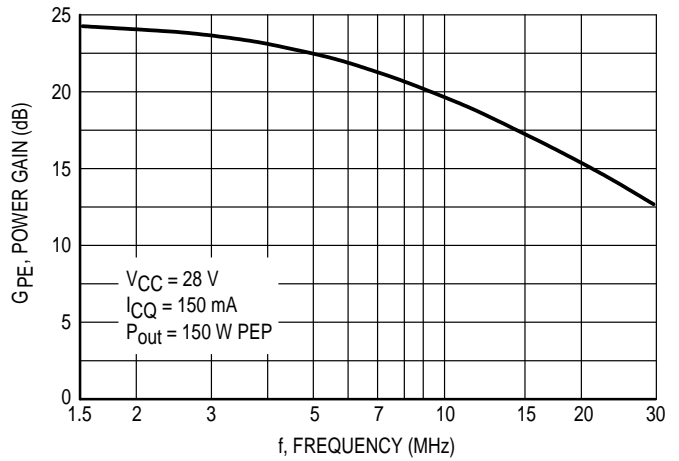

Figure 3. Power Gain versus Frequency

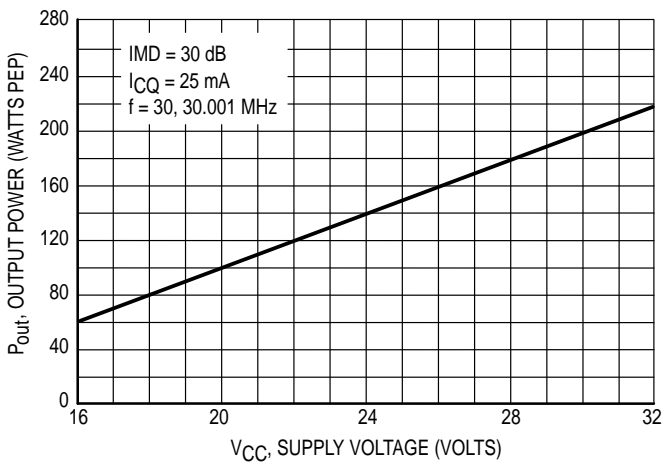

Figure 4. Linear Output Power versus Supply Voltage

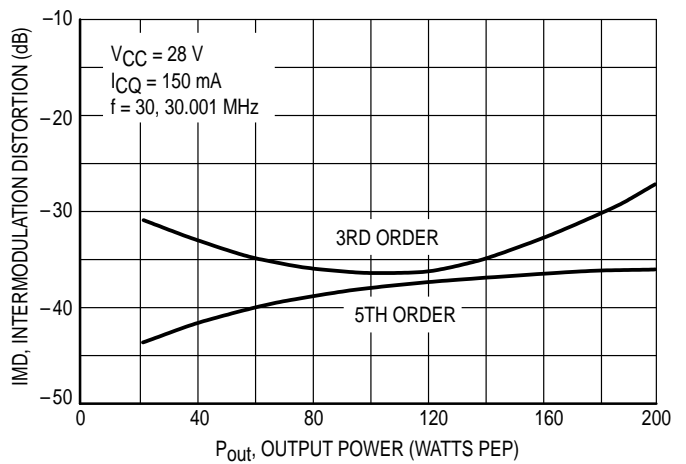

Figure 5. Intermodulation Distortion versus Output Power

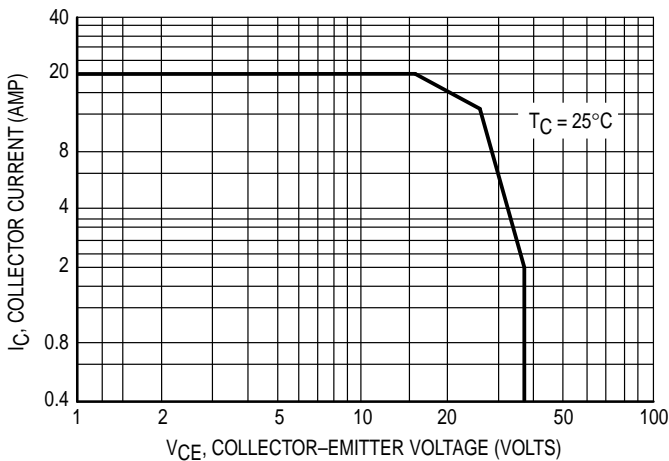

Figure 6. DC Safe Operating Area

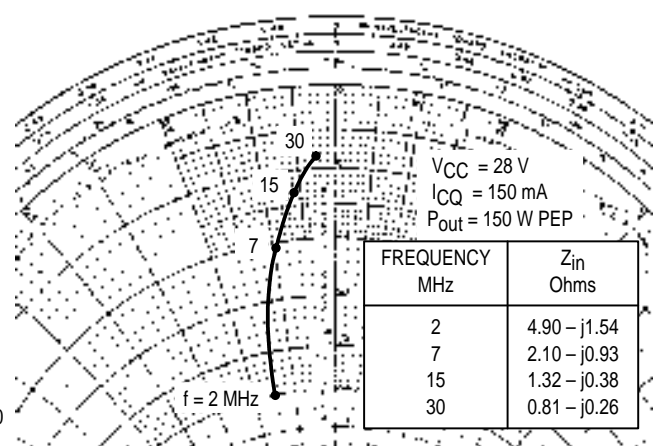

Figure 7. Series Input Impedance

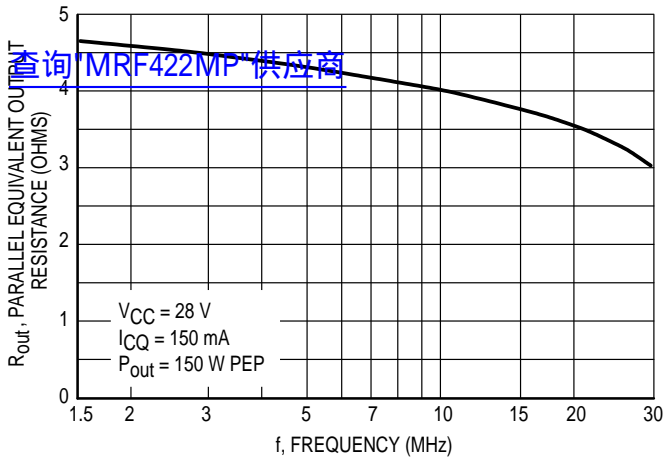

Figure 8. Output Resistance versus Frequency

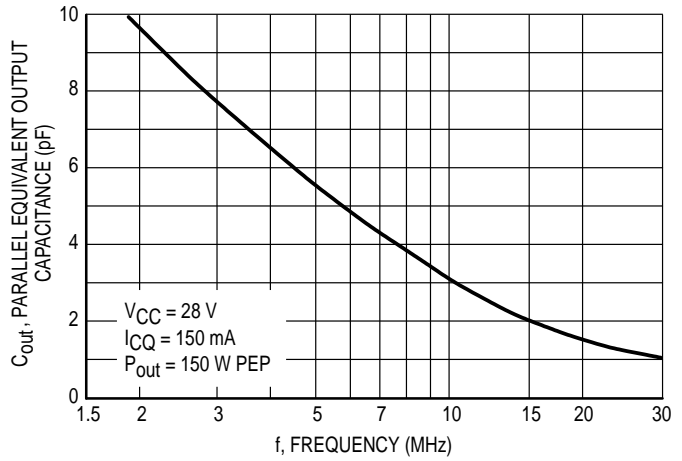
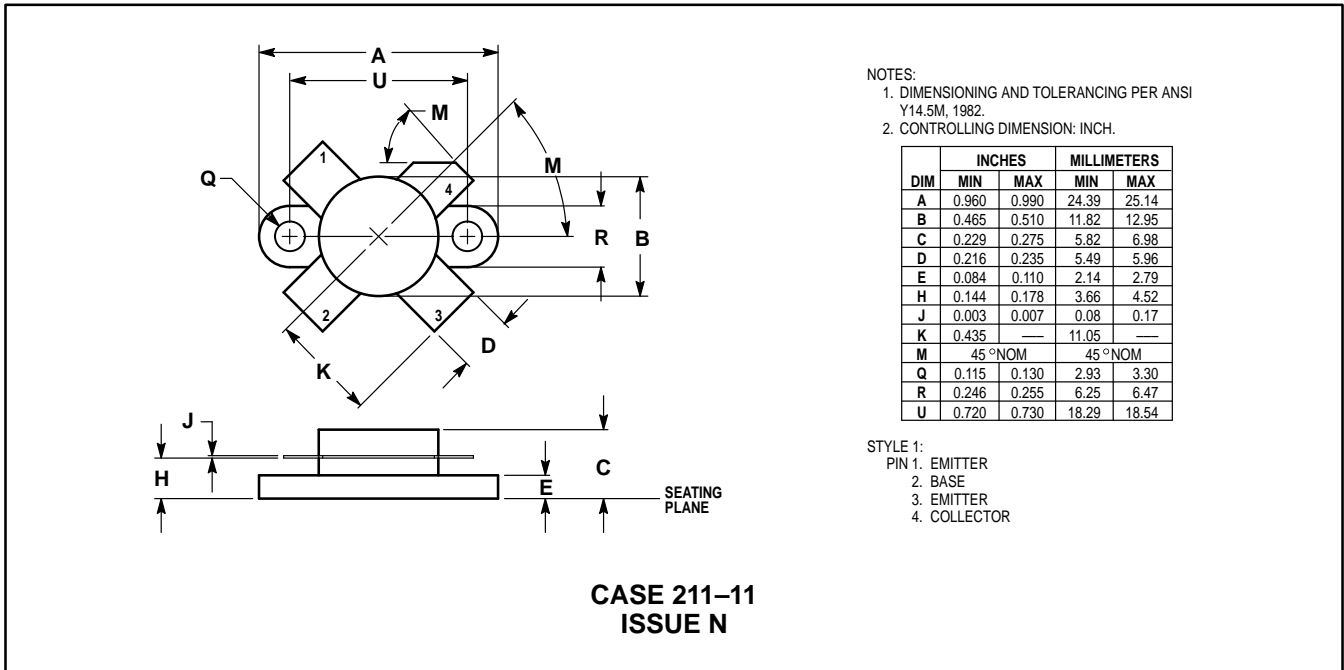

Figure 9. Output Capacitance versus Frequency

PACKAGE DIMENSIONS



Motorola reserves the right to make changes without further notice to any products herein. Motorola makes no warranty, representation or guarantee regarding the suitability of its products for any particular purpose, nor does Motorola assume any liability arising out of the application or use of any product or circuit, and specifically disclaims any and all liability, including without limitation consequential or incidental damages. "Typical" parameters can and do vary in different applications. All operating parameters, including "Typicals" must be validated for each customer application by customer's technical experts. Motorola does not convey any license under its patent rights nor the rights of others. Motorola products are not designed, intended, or authorized for use as components in systems intended for surgical implant into the body, or other applications intended to support or sustain life, or for any other application in which the failure of the Motorola product could create a situation where personal injury or death may occur. Should Buyer purchase or use Motorola products for any such unintended or unauthorized application, Buyer shall indemnify and hold Motorola and its officers, employees, subsidiaries, affiliates, and distributors harmless against all claims, costs, damages, and expenses, and reasonable attorney fees arising out of, directly or indirectly, any claim of personal injury or death associated with such unintended or unauthorized use, even if such claim alleges that Motorola was negligent regarding the design or manufacture of the part. Motorola and are registered trademarks of Motorola, Inc. Motorola, Inc. is an Equal Opportunity/Affirmative Action Employer.

How to reach us:

USA/EUROPE: Motorola Literature Distribution;
 P.O. Box 20912; Phoenix, Arizona 85036. 1-800-441-2447

JAPAN: Nippon Motorola Ltd.; Tatsumi-SPD-JLDC, Toshikatsu Otsuki,
 6F Seibu-Butsuryu-Center, 3-14-2 Tatsumi Koto-Ku, Tokyo 135, Japan. 03-3521-8315

MFAX: RMFAX0@email.sps.mot.com - TOUCHTONE (602) 244-6609
 INTERNET: http://Design-NET.com

HONG KONG: Motorola Semiconductors H.K. Ltd.; 8B Tai Ping Industrial Park,
 51 Ting Kok Road, Tai Po, N.T., Hong Kong. 852-26629298

