

December 1999

LM4865 Boomer® Audio Power Amplifier Series

750 mW Audio Power Amplifier with DC Volume Control and Headphone Switch

General Description

The LM4865 is a mono bridged audio power amplifier with DC volume control, capable of delivering 750 mW of continuous average power into an 8Ω load with less than 1% THD from a 5V power supply. Switching between bridged speaker mode and headphone (single ended) mode is accomplished via a headphone sense pin. In addition, LM4865 is set into low current consumption shutdown mode (0.7 μA typical) by lowering the DC Vol/SD pin to below 0.3V.

Boomer audio power amplifiers are designed specifically to provide high power audio output, with quality sound, from a low supply voltage source while requiring the minimal amount of external components.

Applications

- GSM phones and accessories, DECT, office phones

- Hand held radio
- Other portable audio devices

Key Specifications

- P_O at 1.0% THD+N into 8Ω (SOP): 750 mW (typ)
- P_O at 10% THD+N into 8Ω (SOP): 1W (typ)
- Shutdown Current: 0.7 μA (typ)

Features

- DC volume control
- Headphone amplifier mode
- "Click and pop" suppression
- Shutdown control when volume control pin is low
- Thermal shutdown protection

Typical Application

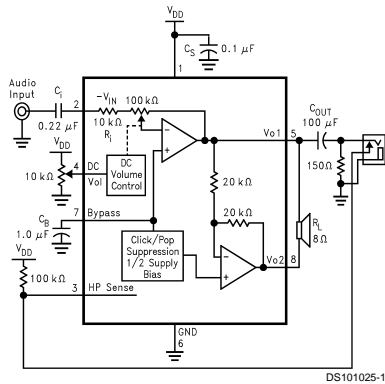
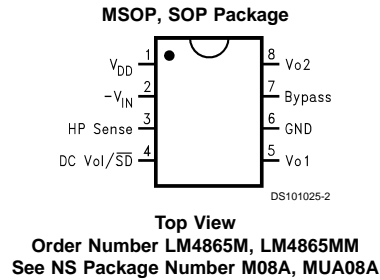

FIGURE 1. Typical Audio Amplifier Application Circuit

Connection Diagram



BOOMER™ is a trademark of National Semiconductor Corporation.

External Components Description

(Figure 1)

Components	Functional Description
1. C_i	Input coupling capacitor which blocks the DC voltage at the amplifier's input terminals. It also creates a highpass filter with the internal R_i . The designer should note that $10k\Omega < (R_i) < 110k\Omega$. Therefore $f_c = 1/(2\pi R_i C_i)$. Refer to the section, Proper Selection of External Components , for an explanation of how to determine the value of C_i .
2. C_S	Supply bypass capacitor which provides power supply filtering. Refer to the Power Supply Bypassing section for information concerning proper placement and selection of the supply bypass capacitor.
3. C_B	Bypass pin capacitor which provides half-supply filtering. Refer to the section, Proper Selection of External Components , for information concerning proper placement and selection of C_B .

Typical Performance Characteristics

THD+N vs Frequency

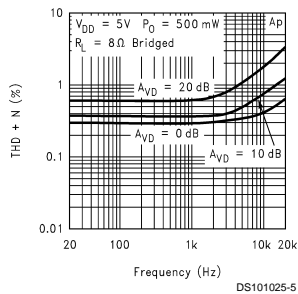

THD+N vs Frequency

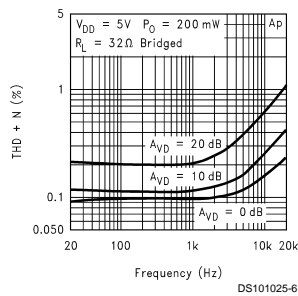

THD+N vs Output Power

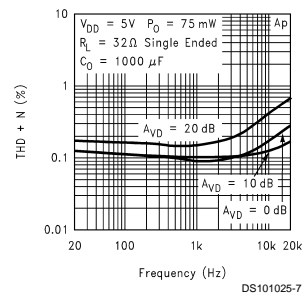

THD+N vs Output Power

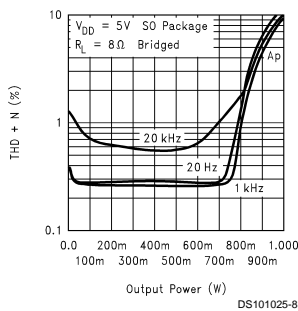

THD+N vs Output Power

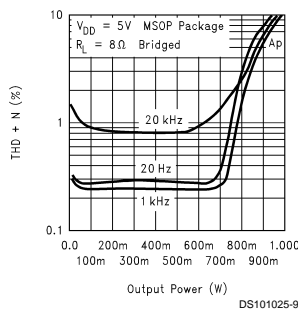

THD+N vs Output Power

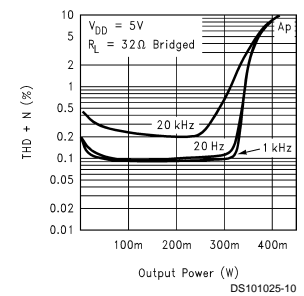

THD+N vs Output Power

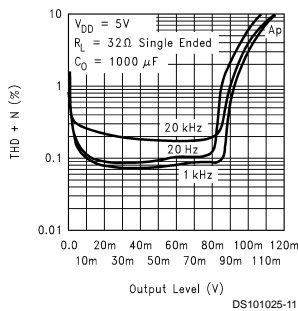

Power Dissipation vs Load Resistance

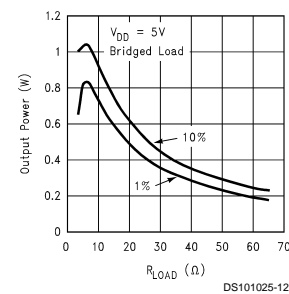

Power Dissipation vs Output Power

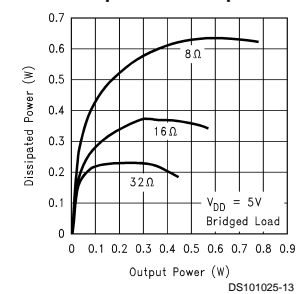

Typical Performance Characteristics (Continued)

Power Derating Curve

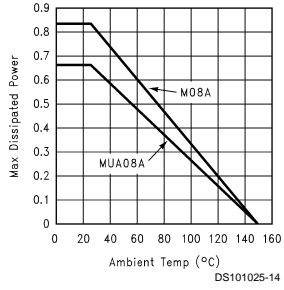

Clipping Voltage vs RL

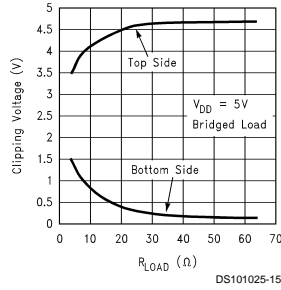

Noise Floor

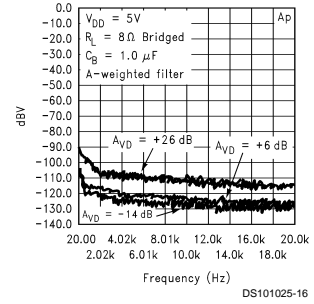

Frequency Response vs Input Capacitor Size

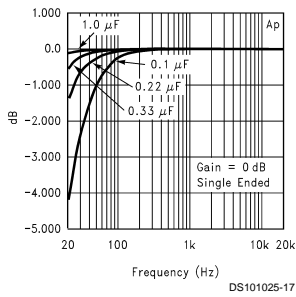

Power Supply Rejection Ratio

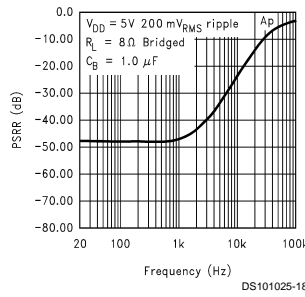

Attenuation Level vs DC-Vol Amplitude

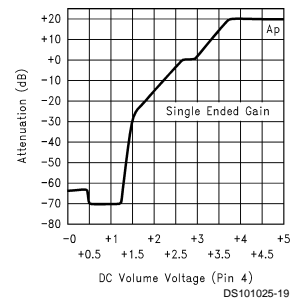

THD+N vs Frequency

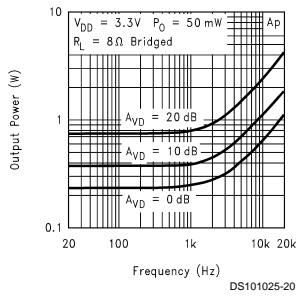

THD+N vs Frequency

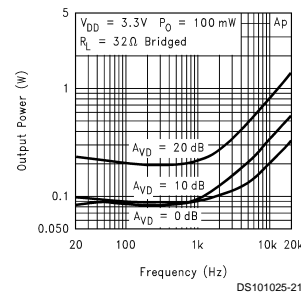

THD+N vs Frequency

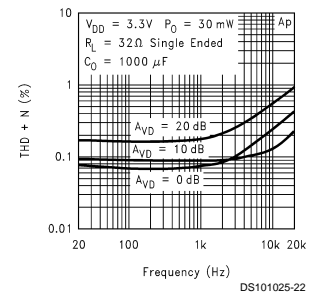

Typical Performance Characteristics (Continued)

THD+N vs Output Power

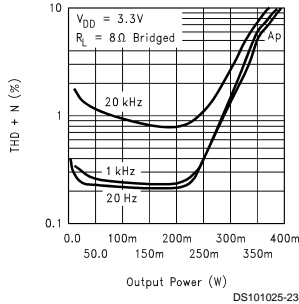

THD+N vs Output Power

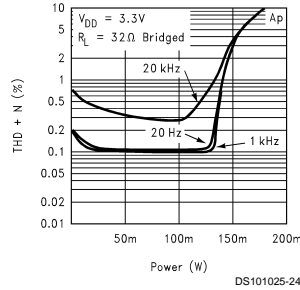

THD+N vs Output Power

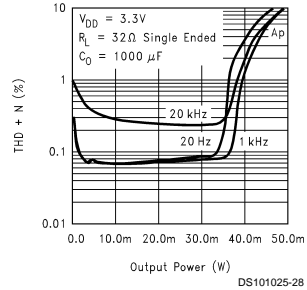

Output Power vs Load Resistance

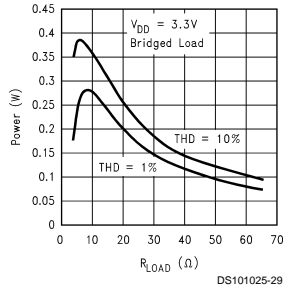

Clipping Voltage vs Supply Voltage

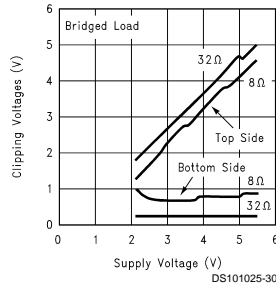

Output Power vs Supply Voltage

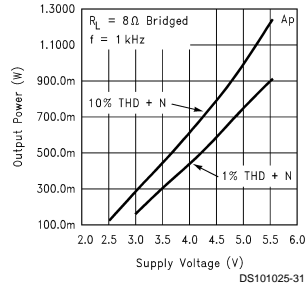

Output Power vs Supply Voltage

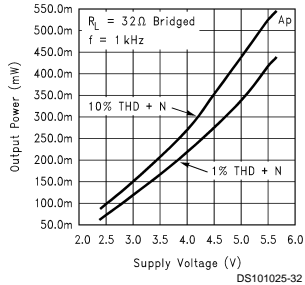

Supply Current vs Supply Voltage

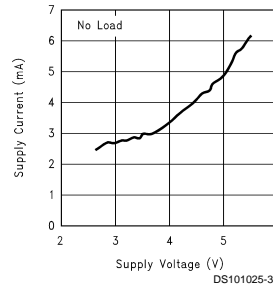

Application Information

BRIDGE CONFIGURATION EXPLANATION

As shown in *Figure 1*, the LM4865 has two operational amplifiers internally, allowing for a few different amplifier configurations. The first amplifier's gain is DC voltage controlled, while the second amplifier is internally fixed in a unity-gain, inverting configuration. The closed-loop gain of the first amplifier is set by an external DC voltage (refer to *Figure 1*), while the second amplifier's gain is fixed by the two internal 20 kΩ resistors.

Figure 1 shows that the output of amplifier one serves as the input to amplifier two which results in both amplifiers producing signals identical in magnitude, but out of phase 180°.

By driving the load differentially through outputs V_{O1} and V_{O2} , an amplifier configuration commonly referred to as "bridged mode" is established. Bridged mode operation is different from the classical single-ended amplifier configuration where one side of its load is connected to ground.

A bridge amplifier design has a few distinct advantages over the single-ended configuration, as it provides differential drive to the load, thus doubling output swing for a specified supply voltage. Four times the output power is possible as compared to a single-ended amplifier under the same conditions. This increase in attainable output assumes that the amplifier is not current limited or clipped. In order to choose an amplifier's closed-loop gain without causing excessive clipping, please refer to the **Audio Power Amplifier Design** section.

Application Information (Continued)

A bridge configuration, such as the one used in LM4865, also creates a second advantage over single-ended amplifiers. Since the differential outputs, V_{O1} and V_{O2} , are biased at half-supply, no net DC voltage exists across the load. This eliminates the need for an output coupling capacitor which is required in a single supply, single-ended amplifier configuration. If an output coupling capacitor is not used in a single-ended configuration, the half-supply bias across the load would result in both increased internal IC power dissipation as well as permanent loudspeaker damage.

POWER DISSIPATION

Power dissipation is a major concern when designing a successful amplifier, whether the amplifier is bridged or single-ended. Equation (1) states the maximum power dissipation point for a single-ended amplifier operating at a given supply voltage and driving a specified output load.

$$P_{DMAX} = (V_{DD})^2 / (2\pi^2 R_L) \quad \text{Single-Ended} \quad (1)$$

However, a direct consequence of the increased power delivered to the load by a bridge amplifier is an increase in internal power dissipation point for a bridge amplifier operating at the same given conditions.

$$P_{DMAX} = 4 * (V_{DD})^2 / (2\pi^2 R_L) \quad \text{Bridge Mode} \quad (2)$$

Since the LM4865 has two operational amplifiers in one package, the maximum internal power dissipation is 4 times that of a single-ended amplifier. Even with this substantial increase in power dissipation, the LM4865 does not require heatsinking. From Equation (1), assuming a 5V power supply and an 8Ω load, the maximum power dissipation point is 633 mW. The maximum power dissipation point obtained from Equation (2) must not be greater than the power dissipation that results from Equation (3):

$$P_{DMAX} = (T_{JMAX} - T_A) / \theta_{JA} \quad (3)$$

For package M08A, $\theta_{JA} = 150^\circ\text{C/W}$, and for package MUA08A, $\theta_{JA} = 190^\circ\text{C/W}$. $T_{JMAX} = 150^\circ\text{C}$ for the LM4865. Depending on the ambient temperature, T_A , of the system surroundings, Equation (3) can be used to find the maximum internal power dissipation supported by the IC packaging. If the result of Equation (2) is greater than that of Equation (3), then either the supply voltage must be decreased, the load impedance increased, or the ambient temperature reduced. For the typical application of a 5V power supply, with an 8Ω load, the maximum temperature possible without violating the maximum junction temperature is approximately 55°C provided that device operation is around the maximum power dissipation point and assuming surface mount packaging. Internal power dissipation is a function of output power. If typical operation is not around the maximum power dissipation point, the ambient temperature can be increased. Refer to the **Typical Performance Characteristics** curves for power dissipation information for lower output powers.

POWER SUPPLY BYPASSING

As with any power amplifier, proper supply bypassing is critical for low noise performance and high power supply rejection. The capacitor location on both the bypass and power supply pins should be as close to the device as possible. The effect of a larger half supply bypass capacitor is improved PSRR due to increased half-stability. Typical applications employ a 5V regulator with 10 μF and a 0.1 μF bypass capacitors which aid in supply stability, but do not eliminate the need for bypassing the supply nodes of the LM4865. The selection of bypass capacitors, especially C_B , is thus dependent upon desired PSRR requirements, click and pop performance as explained in the section, **Proper Selection of External Components**, system cost, and size constraints.

dent upon desired PSRR requirements, click and pop performance as explained in the section, **Proper Selection of External Components**, system cost, and size constraints.

SHUTDOWN FUNCTION

In order to reduce power consumption while not in use, the LM4865 contains a DC Vol/SD pin. The DC Vol/SD pin allows the LM4865 to externally turn off the amplifier's bias circuitry. The shutdown feature turns the amplifier off when the DC Vol/SD pin is brought below 0.3 volts. When the DC Vol/SD pin is between 0.3V to 0.5V, the LM4865 will be either be in shutdown or mute mode. In mute mode the current drawn will be that of the quiescent supply current. The DC Vol/SD pin should be tied to GND supply rail for best performance if the LM4865 is to go into shutdown mode. As the DC Vol/SD is increased above 0.5V the amplifier will follow the attenuation and gain curve in **Typical Performance Characteristics**.

HP-Sense FUNCTION

The LM4865 possesses a headphone control pin that turns off the amplifier which drives +Vo2 so that single-ended operation can occur and a bridged connected load is muted. Quiescent current consumption is reduced when the IC is in this single-ended mode.

Figure 2 shows the implementation of the LM4865's headphone control function using a single-supply headphone amplifier. The voltage divider of R1 and R2 sets the voltage at the HP-Sense pin (pin 3) to be approximately 50 mV when there are no headphones plugged into the system. This logic-low voltage at the HP-Sense pin enables the LM4865 and places it in bridged mode operation. The output coupling capacitors protect the headphones by blocking the amplifier's half supply DC voltage.

When there are no headphones plugged into the system and the IC is in bridged mode configuration, both loads are essentially at a 0V DC potential. Since the HP-Sense threshold is set at 4V, even in an ideal situation, the output swing cannot cause a false single-ended trigger.

When a set of headphones are plugged into the system, the contact pin of the headphone jack is disconnected from the signal pin, interrupting the voltage divider set up by resistors R1 and R2. Resistor R1 then pulls up the HP-Sense pin, enabling the headphone function. This disables the second side of the amplifier thus muting the bridged speakers. The amplifier then drives the headphones, whose impedance is in parallel with resistor R2. Resistor R2 has negligible effect on output drive capability since the typical impedance of headphones are 32Ω.

The LM4865 can be used to drive both a bridged 8Ω speaker and a 32Ω headphone without using the HP-Sense pin. In this case the HP-Sense would not be connected to the headphone jack but to a microprocessor or a switch. By enabling the HP-Sense pin, the 8Ω speaker can be muted.

PROPER SELECTION OF EXTERNAL COMPONENTS

Proper selection of external components in applications using integrated power amplifiers is critical to optimize device and system performance. While the LM4865 is tolerant to a variety of external component combinations, consideration to component values must be used to maximize overall system quality.

Application Information (Continued)

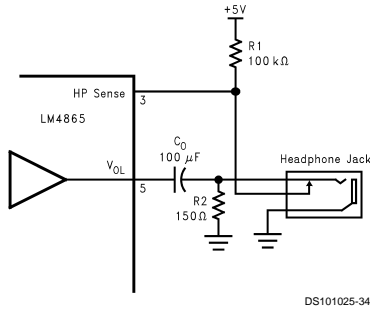

FIGURE 2. Headphone Circuit

Selection of Input Capacitor Size

Large input capacitors are both expensive and space hungry for portable designs. Clearly, a certain sized capacitor is needed to couple in low frequencies without severe attenuation. But in many cases the speakers used in portable systems, whether internal or external, have little ability to reproduce signals below 150 Hz. In this case using a large input capacitor may not increase system performance.

Besides minimizing the input capacitor size, careful consideration should be paid to the bypass capacitor value. Bypass capacitor, C_B , is the most critical component to minimize turn-on pops since it determines how fast the LM4865 turns on. The slower the LM4865's outputs ramp to their quiescent DC voltage (nominally $1/2 V_{DD}$), the smaller the turn-on pop. Choosing C_B equal to $1.0 \mu F$ along with a small value of C_i (in the range of $0.1 \mu F$ to $0.39 \mu F$), should produce a clickless and popless shutdown function. Pick C_i as small as possible as to minimize clicks and pops.

Click And Pop Circuitry

The LM4865 contains circuitry to minimize turn-on and shut-down transients or "clicks and pops". In this case, turn-on refers to either power supply turn-on or the device coming out of shutdown mode. When the device is turning on, the amplifiers are internally configured as unity gain buffers. An internal current source ramps up the voltage of the bypass pin. Both the inputs and outputs ideally track the voltage at the bypass pin. The device will remain in buffer mode until the bypass pin has reached its half supply voltage, $1/2 V_{DD}$. As soon as the bypass node is stable, the device will become fully operational, where the gain is set by the external voltage on the DC Vol/SD pin.

Although the bypass pin current source cannot be modified, the size of C_B can be changed to alter the device turn-on time and the amount of "clicks and pops". By increasing the value of C_B the amount of turn-on pop can be reduced. However, the tradeoff for using a larger bypass capacitor is an increase in turn-on time for this device. There is a linear relationship between the size of C_B and the turn-on time. Here are some typical turn-on times for a given C_B :

C_B	T_{ON}
0.01 μF	20 ms
0.1 μF	200 ms
0.22 μF	420 ms
0.47 μF	840 ms
1.0 μF	2 Sec

In order eliminate "clicks and pops", all capacitors must be discharged before turn-on. Rapid switching of V_{DD} may cause the "clicks and pops" to be not easily controlled. In a single-ended configuration, the output coupling capacitor, C_o , is of particular concern. This capacitor discharges through internal $20 k\Omega$ resistors. Depending on the size of C_o , the time constant can be relatively large. To reduce transients in single-ended mode, an external $1 k\Omega$ – $5 k\Omega$ resistor can be placed in parallel with the internal $20 k\Omega$ resistor. The tradeoff for using this resistor is an increase in quiescent current.

LM4865

Physical Dimensions inches (millimeters) unless otherwise noted

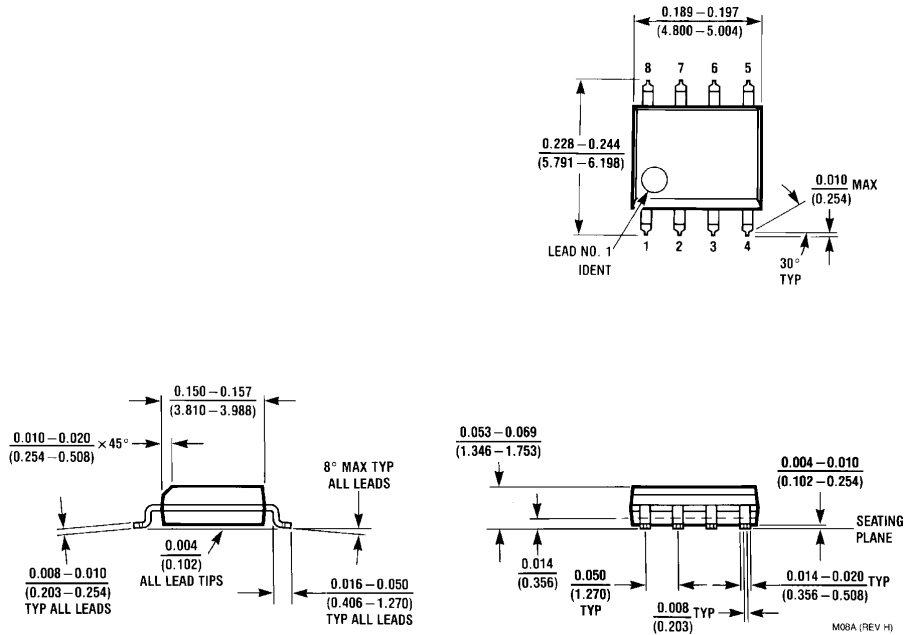

Order Number LM4865M
NS Package Number M08A

Physical Dimensions inches (millimeters) unless otherwise noted (Continued)

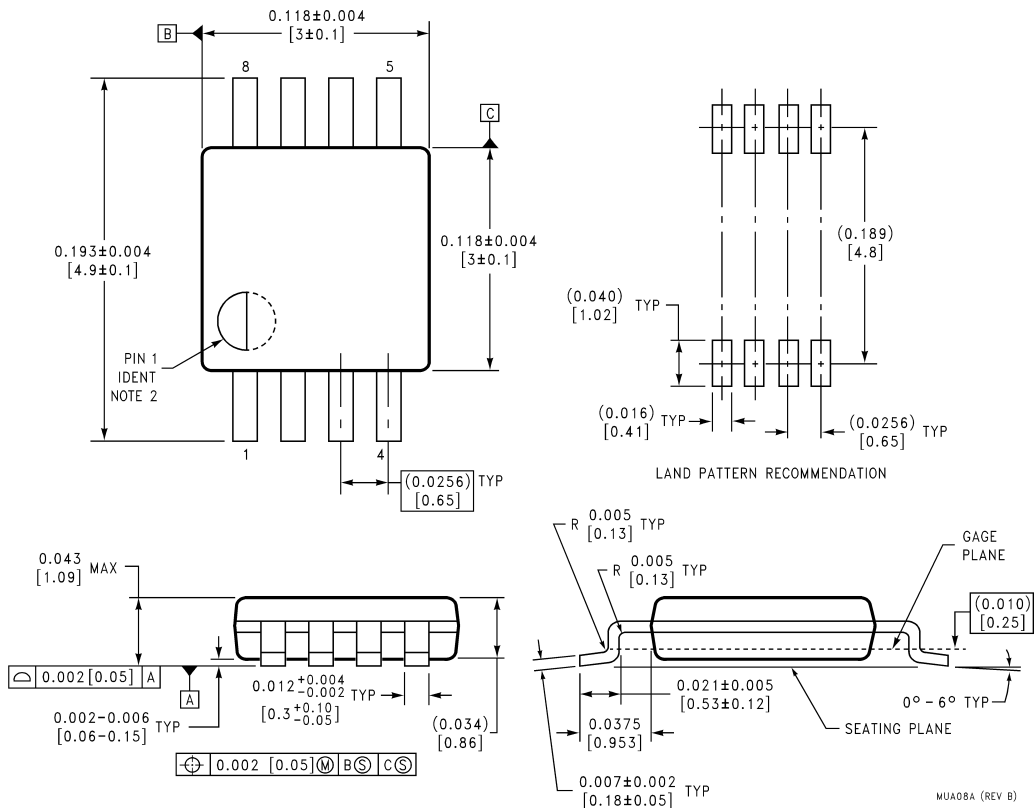

8-Lead (0.118" Wide) Molded Mini Small Outline Package
Order Number LM4865MM
NS Package Number MUA08A

LIFE SUPPORT POLICY

NATIONAL'S PRODUCTS ARE NOT AUTHORIZED FOR USE AS CRITICAL COMPONENTS IN LIFE SUPPORT DEVICES OR SYSTEMS WITHOUT THE EXPRESS WRITTEN APPROVAL OF THE PRESIDENT AND GENERAL COUNSEL OF NATIONAL SEMICONDUCTOR CORPORATION. As used herein:

1. Life support devices or systems are devices or systems which, (a) are intended for surgical implant into the body, or (b) support or sustain life, and whose failure to perform when properly used in accordance with instructions for use provided in the labeling, can be reasonably expected to result in a significant injury to the user.
2. A critical component is any component of a life support device or system whose failure to perform can be reasonably expected to cause the failure of the life support device or system, or to affect its safety or effectiveness.

National Semiconductor Corporation
 Americas
 Tel: 1-800-272-9959
 Fax: 1-800-737-7018
 Email: support@nsc.com
 www.national.com

National Semiconductor Europe
 Fax: +49 (0) 1 80-530 85 86
 Email: europe.support@nsc.com
 Deutsch Tel: +49 (0) 1 80-530 85 85
 English Tel: +49 (0) 1 80-532 78 32
 Français Tel: +49 (0) 1 80-532 93 58
 Italiano Tel: +49 (0) 1 80-534 16 80

National Semiconductor Asia Pacific Customer Response Group
 Tel: 65-2544466
 Fax: 65-2504466
 Email: sea.support@nsc.com

National Semiconductor Japan Ltd.
 Tel: 81-3-5639-7560
 Fax: 81-3-5639-7507