

ULTRA SMALL, LOW INPUT VOLTAGE, LOW r_{ON} , LOAD SWITCHES

FEATURES

- Low Input Voltage: 1.0 V to 3.6 V
- Ultra-Low ON Resistance
 - $r_{ON} = 78 \text{ m}\Omega$ at $V_{IN} = 3.6 \text{ V}$
 - $r_{ON} = 93 \text{ m}\Omega$ at $V_{IN} = 2.5 \text{ V}$
 - $r_{ON} = 109 \text{ m}\Omega$ at $V_{IN} = 1.8 \text{ V}$
 - $r_{ON} = 146 \text{ m}\Omega$ at $V_{IN} = 1.2 \text{ V}$
- 500-mA Maximum Continuous Switch Current
- Ultra Low Quiescent Current: 82 nA at 1.8 V
- Ultra Low Shutdown Current: 44 nA at 1.8 V
- Low Control Input Thresholds Enable Use of 1.2-V/1.8-V/2.5-V/3.3-V Logic
- Controlled Slew Rate to Avoid Inrush Currents
 - TPS22901 and TPS22902: 40- μs t_r
 - TPS22902B: 220- μs t_r
- ESD Performance Tested Per JESD 22
 - 2000-V Human-Body Model (A114-B, Class II)
 - 1000-V Charged-Device Model (C101)
- Four-Terminal Wafer-Chip-Scale Package (WCSP)
 - 0.8 mm \times 0.8 mm, 0.4 mm Pitch, 0.5 mm Height

APPLICATIONS

- Personal Digital Assistants (PDAs)
- Cellular Phones
- GPS Devices
- MP3 Players
- Digital Cameras
- Peripheral Ports
- Portable Instrumentation
- RF Modules

DESCRIPTION

TPS22901, TPS22902, and TPS22902B are ultra-small, low ON resistance (r_{ON}) load switches with controlled turn on. The devices contain a P-channel MOSFET that operates over an input voltage range of 1.0 V to 3.6 V. The switch is controlled by an on/off input (ON), which is capable of interfacing directly with low-voltage control signals. In TPS22902 and in TPS22902B, a 120- Ω on-chip load resistor is added for output quick discharge when the switch is turned off.

TPS22901, TPS22902, and TPS22902B are available in a space-saving 4-terminal WCSP with 0.4-mm pitch (YFP). The devices are characterized for operation over the free-air temperature range of -40°C to 85°C .

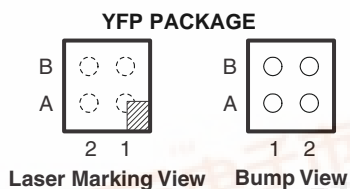

TERMINAL ASSIGNMENTS

B	ON	GND
A	V_{IN}	V_{OUT}
	2	1

	r_{ON} at 1.8 V (TYP)	SLEW RATE (TYP at 1.8 V)	QUICK OUTPUT DISCHARGE ⁽¹⁾	MAX OUTPUT CURRENT	ENABLE
TPS22901	109 m Ω	40 μs		500 mA	Active high
TPS22902	109 m Ω	40 μs	Yes	500 mA	Active high
TPS22902B	109 m Ω	220 μs	Yes	500 mA	Active high

(1) This feature discharges the output of the switch to ground through a 120- Ω resistor, preventing the output from floating.



Please be aware that an important notice concerning availability, standard warranty, and use in critical applications of Texas Instruments semiconductor products and disclaimers thereto appears at the end of this data sheet.

PRODUCTION DATA information is current as of publication date. Products conform to specifications per the terms of the Texas Instruments standard warranty. Production processing does not necessarily include testing of all parameters.

Copyright © 2008–2009, Texas Instruments Incorporated



[查询 TPS22901 供应商](#)

ORDERING INFORMATION

T _A	PACKAGE ⁽¹⁾⁽²⁾		ORDERABLE PART NUMBER	TOP-SIDE MARKING
-40°C to 85°C	WCSP – YFP (0.4 mm pitch)	Tape and reel	TPS22901YFPR	__ _3P _
			TPS22902YFPR	__ _3R _
			TPS22902BYFPR	__ _3S _

- (1) Package drawings, thermal data, and symbolization are available at www.ti.com/packaging.
- (2) For the most current package and ordering information, see the Package Option Addendum at the end of this document, or see the TI website at www.ti.com.

TYPICAL APPLICATION

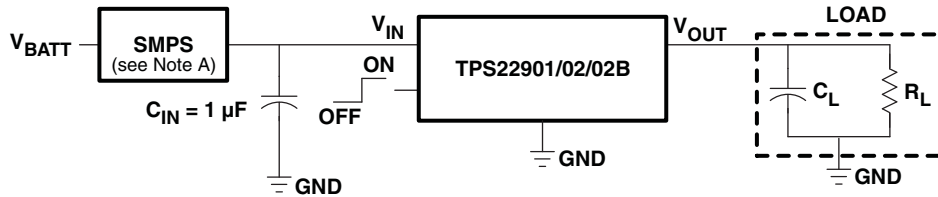

A. Switched mode power supply

APPLICATION BLOCK DIAGRAM

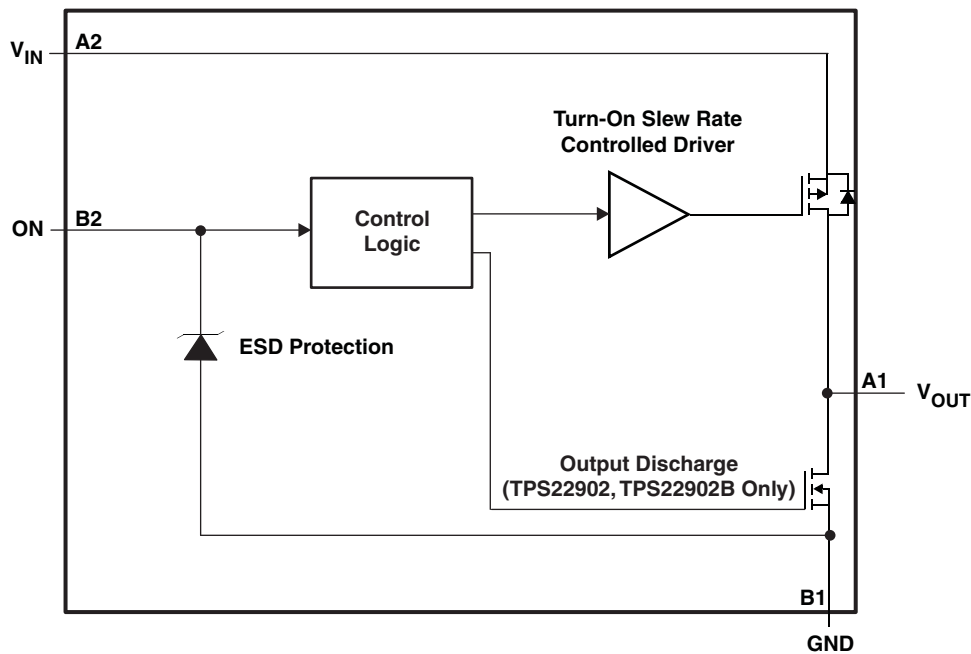

Figure 1. Functional Block Diagram

FUNCTION TABLE

ON (Control Input)	V _{IN} to V _{OUT}	V _{OUT} to GND (TPS22902, TPS22902B only)
L	OFF	ON
H	ON	OFF

TERMINAL FUNCTIONS

TERMINAL		DESCRIPTION
BALL NO.	NAME	
A1	V _{OUT}	Switch output
A2	V _{IN}	Switch input, bypass this input with a ceramic capacitor to ground
B1	GND	Ground
B2	ON	Switch control input, active high

ABSOLUTE MAXIMUM RATINGS⁽¹⁾

		MIN	MAX	UNIT	
V _{IN}	Input voltage range	-0.3	4	V	
V _{OUT}	Output voltage range		V _{IN} + 0.3	V	
V _{ON}	Input voltage range	-0.3	4	V	
P	Power dissipation at T _A = 25°C		0.48	W	
I _{MAX}	Maximum continuous switch current		500	mA	
T _A	Operating free-air temperature range	-40	85	°C	
T _{stg}	Storage temperature range	-65	150	°C	
T _{lead}	Maximum lead temperature (10-s soldering time)		300	°C	
ESD	Electrostatic discharge protection		Human-Body Model (HBM)	2000	V
			Charged Device Model (CDM)	1000	

(1) Stresses beyond those listed under absolute maximum ratings may cause permanent damage to the device. These are stress ratings only, and functional operation of the device at these or any other conditions beyond those indicated under *Recommended Operating Conditions* is not implied. Exposure to absolute-maximum-rated conditions for extended periods may affect device reliability.

THERMAL IMPEDANCE RATINGS

			UNIT
θ _{JA}	Package thermal impedance ⁽¹⁾	YFP package	205 °C/W

(1) The package thermal impedance is calculated in accordance with JESD 51-7.

RECOMMENDED OPERATING CONDITIONS

		MIN	MAX	UNIT
V _{IN}	Input voltage range	1	3.6	V
V _{OUT}	Output voltage range		V _{IN}	
V _{IH}	High-level input voltage, ON	0.85	3.6	V
V _{IL}	Low-level input voltage, ON		0.4	V
C _{IN}	Input capacitor	1 ⁽¹⁾		μF

(1) See [Application Information](#).

[查询 TPS22901 供应商](#)

ELECTRICAL CHARACTERISTICS

V_{IN} = 1.0 V to 3.6 V, T_A = -40°C to 85°C (unless otherwise noted)

PARAMETER		TEST CONDITIONS	T _A	MIN	TYP ⁽¹⁾	MAX	UNIT			
I _{IN}	Quiescent current	I _{OUT} = 0, V _{IN} = V _{ON}	V _{IN} = 1.1 V	Full	37	120	nA			
			V _{IN} = 1.8 V	Full	82	235				
			V _{IN} = 3.6 V	Full	204	880				
I _{IN(OFF)}	OFF-state supply current	V _{ON} = GND, OUT = Open	V _{IN} = 1.1 V	Full	22	210	nA			
			V _{IN} = 1.8 V	Full	44	260				
			V _{IN} = 3.6 V	Full	137	700				
I _{IN(LEAKAGE)}	OFF-state switch current	V _{ON} = GND, V _{OUT} = 0	V _{IN} = 1.1 V	Full	22	140	nA			
			V _{IN} = 1.8 V	Full	45	230				
			V _{IN} = 3.6 V	Full	137	610				
r _{ON}	ON-state resistance	I _{OUT} = - 200 mA	V _{IN} = 3.6 V	25°C	78	95	mΩ			
				Full		95				
			V _{IN} = 2.5 V	25°C	93	110				
				Full		110				
			V _{IN} = 1.8 V	25°C	109	130				
				Full		130				
			V _{IN} = 1.2 V	25°C	146	200				
				Full		200				
			V _{IN} = 1.1 V	25°C	174	330				
				Full		330				
			r _{PD}	Output pulldown resistance	V _{IN} = 3.3 V, V _{ON} = 0, I _{OUT} = 30 mA (TPS22902/TPS22902B only)	25°C		88	120	Ω
			I _{ON}	ON input leakage current	V _{ON} = 1.1 V to 3.6 V or GND	Full			25	nA

(1) Typical values are at the specified V_{IN} and T_A = 25°C.

SWITCHING CHARACTERISTICS
 $V_{IN} = 1.1\text{ V}$, $T_A = 25^\circ\text{C}$ (unless otherwise noted)

PARAMETER	TEST CONDITIONS		TPS22901			TPS22902 ⁽¹⁾			TPS22902B ⁽¹⁾			UNIT
			MIN	TYP	MAX	MIN	TYP	MAX	MIN	TYP	MAX	
t_{ON} Turn-ON time	$R_L = 500\ \Omega$	$C_L = 0.1\ \mu\text{F}$	108			108			531			μs
		$C_L = 1\ \mu\text{F}$	131			131			596			
		$C_L = 3.3\ \mu\text{F}$	153			153			659			
t_{OFF} Turn-OFF time	$R_L = 500\ \Omega$	$C_L = 0.1\ \mu\text{F}$	39			11			11			μs
		$C_L = 1\ \mu\text{F}$	317			69			67			
		$C_L = 3.3\ \mu\text{F}$	1105			238			225			
t_r V_{OUT} rise time	$R_L = 500\ \Omega$	$C_L = 0.1\ \mu\text{F}$	70			70			365			μs
		$C_L = 1\ \mu\text{F}$	78			78			367			
		$C_L = 3.3\ \mu\text{F}$	92			92			395			
t_f V_{OUT} fall time	$R_L = 500\ \Omega$	$C_L = 0.1\ \mu\text{F}$	107			18			21			μs
		$C_L = 1\ \mu\text{F}$	966			175			189			
		$C_L = 3.3\ \mu\text{F}$	3532			632			565			

 (1) $R_{L_CHIP} = 120\ \Omega$
SWITCHING CHARACTERISTICS
 $V_{IN} = 1.2\text{ V}$, $T_A = 25^\circ\text{C}$ (unless otherwise noted)

PARAMETER	TEST CONDITIONS		TPS22901			TPS22902 ⁽¹⁾			TPS22902B ⁽¹⁾			UNIT
			MIN	TYP	MAX	MIN	TYP	MAX	MIN	TYP	MAX	
t_{ON} Turn-ON time	$R_L = 500\ \Omega$	$C_L = 0.1\ \mu\text{F}$	96			96			471			μs
		$C_L = 1\ \mu\text{F}$	116			116			527			
		$C_L = 3.3\ \mu\text{F}$	135			135			587			
t_{OFF} Turn-OFF time	$R_L = 500\ \Omega$	$C_L = 0.1\ \mu\text{F}$	39			10			10			μs
		$C_L = 1\ \mu\text{F}$	317			62			61			
		$C_L = 3.3\ \mu\text{F}$	1110			210			199			
t_r V_{OUT} rise time	$R_L = 500\ \Omega$	$C_L = 0.1\ \mu\text{F}$	62			62			324			μs
		$C_L = 1\ \mu\text{F}$	69			69			325			
		$C_L = 3.3\ \mu\text{F}$	81			81			350			
t_f V_{OUT} fall time	$R_L = 500\ \Omega$	$C_L = 0.1\ \mu\text{F}$	109			17			20			μs
		$C_L = 1\ \mu\text{F}$	995			163			175			
		$C_L = 3.3\ \mu\text{F}$	3650			587			523			

 (1) $R_{L_CHIP} = 120\ \Omega$

SWITCHING CHARACTERISTICS

V_{IN} = 1.8 V, T_A = 25°C (unless otherwise noted)

PARAMETER	TEST CONDITIONS		TPS22901			TPS22902 ⁽¹⁾			TPS22902B ⁽¹⁾			UNIT
			MIN	TYP	MAX	MIN	TYP	MAX	MIN	TYP	MAX	
t _{ON} Turn-ON time	R _L = 500 Ω	C _L = 0.1 μF	61			61			302			μs
		C _L = 1 μF	72			72			335			
		C _L = 3.3 μF	83			83			367			
t _{OFF} Turn-OFF time	R _L = 500 Ω	C _L = 0.1 μF	38			8			8			μs
		C _L = 1 μF	317			49			49			
		C _L = 3.3 μF	1135			169			167			
t _r V _{OUT} rise time	R _L = 500 Ω	C _L = 0.1 μF	40			40			220			μs
		C _L = 1 μF	45			45			220			
		C _L = 3.3 μF	53			53			235			
t _f V _{OUT} fall time	R _L = 500 Ω	C _L = 0.1 μF	111			15			15			μs
		C _L = 1 μF	1020			140			159			
		C _L = 3.3 μF	3700			517			481			

(1) R_L_CHIP = 120 Ω

SWITCHING CHARACTERISTICS

V_{IN} = 2.5 V, T_A = 25°C (unless otherwise noted)

PARAMETER	TEST CONDITIONS		TPS22901			TPS22902 ⁽¹⁾			TPS22902B ⁽¹⁾			UNIT
			MIN	TYP	MAX	MIN	TYP	MAX	MIN	TYP	MAX	
t _{ON} Turn-ON time	R _L = 500 Ω	C _L = 0.1 μF	45			45			223			μs
		C _L = 1 μF	53			53			246			
		C _L = 3.3 μF	61			61			268			
t _{OFF} Turn-OFF time	R _L = 500 Ω	C _L = 0.1 μF	38			7			7			μs
		C _L = 1 μF	314			46			47			
		C _L = 3.3 μF	1140			161			158			
t _r V _{OUT} rise time	R _L = 500 Ω	C _L = 0.1 μF	32			32			175			μs
		C _L = 1 μF	35			35			175			
		C _L = 3.3 μF	41			41			187			
t _f V _{OUT} fall time	R _L = 500 Ω	C _L = 0.1 μF	113			14			18			μs
		C _L = 1 μF	1040			139			185			
		C _L = 3.3 μF	3795			516			471			

(1) R_L_CHIP = 120 Ω

SWITCHING CHARACTERISTICS
 $V_{IN} = 3\text{ V}$, $T_A = 25^\circ\text{C}$ (unless otherwise noted)

PARAMETER	TEST CONDITIONS		TPS22901			TPS22902 ⁽¹⁾			TPS22902B ⁽¹⁾			UNIT
			MIN	TYP	MAX	MIN	TYP	MAX	MIN	TYP	MAX	
t_{ON} Turn-ON time	$R_L = 500\ \Omega$	$C_L = 0.1\ \mu\text{F}$	38			38			191			μs
		$C_L = 1\ \mu\text{F}$	45			45			211			
		$C_L = 3.3\ \mu\text{F}$	53			53			231			
t_{OFF} Turn-OFF time	$R_L = 500\ \Omega$	$C_L = 0.1\ \mu\text{F}$	38			7			7			μs
		$C_L = 1\ \mu\text{F}$	320			46			46			
		$C_L = 3.3\ \mu\text{F}$	1145			53			156			
t_r V_{OUT} rise time	$R_L = 500\ \Omega$	$C_L = 0.1\ \mu\text{F}$	28			28			159			μs
		$C_L = 1\ \mu\text{F}$	31			31			160			
		$C_L = 3.3\ \mu\text{F}$	37			37			170			
t_f V_{OUT} fall time	$R_L = 500\ \Omega$	$C_L = 0.1\ \mu\text{F}$	114			14			17			μs
		$C_L = 1\ \mu\text{F}$	1045			139			160			
		$C_L = 3.3\ \mu\text{F}$	3815			509			473			

 (1) $R_{L_CHIP} = 120\ \Omega$
SWITCHING CHARACTERISTICS
 $V_{IN} = 3.6\text{ V}$, $T_A = 25^\circ\text{C}$ (unless otherwise noted)

PARAMETER	TEST CONDITIONS		TPS22901			TPS22902 ⁽¹⁾			TPS22902B ⁽¹⁾			UNIT
			MIN	TYP	MAX	MIN	TYP	MAX	MIN	TYP	MAX	
t_{ON} Turn-ON time	$R_L = 500\ \Omega$	$C_L = 0.1\ \mu\text{F}$	33			33			166			μs
		$C_L = 1\ \mu\text{F}$	39			39			183			
		$C_L = 3.3\ \mu\text{F}$	46			46			201			
t_{OFF} Turn-OFF time	$R_L = 500\ \Omega$	$C_L = 0.1\ \mu\text{F}$	38			7			7			μs
		$C_L = 1\ \mu\text{F}$	322			46			45			
		$C_L = 3.3\ \mu\text{F}$	1145			156			155			
t_r V_{OUT} rise time	$R_L = 500\ \Omega$	$C_L = 0.1\ \mu\text{F}$	25			25			146			μs
		$C_L = 1\ \mu\text{F}$	28			28			146			
		$C_L = 3.3\ \mu\text{F}$	34			34			156			
t_f V_{OUT} fall time	$R_L = 500\ \Omega$	$C_L = 0.1\ \mu\text{F}$	116			14			17			μs
		$C_L = 1\ \mu\text{F}$	1060			139			161			
		$C_L = 3.3\ \mu\text{F}$	3840			512			475			

 (1) $R_{L_CHIP} = 120\ \Omega$

[查询 TPS22901 供应商](#)

TYPICAL CHARACTERISTICS

TPS22901, TPS22902, TPS22902B

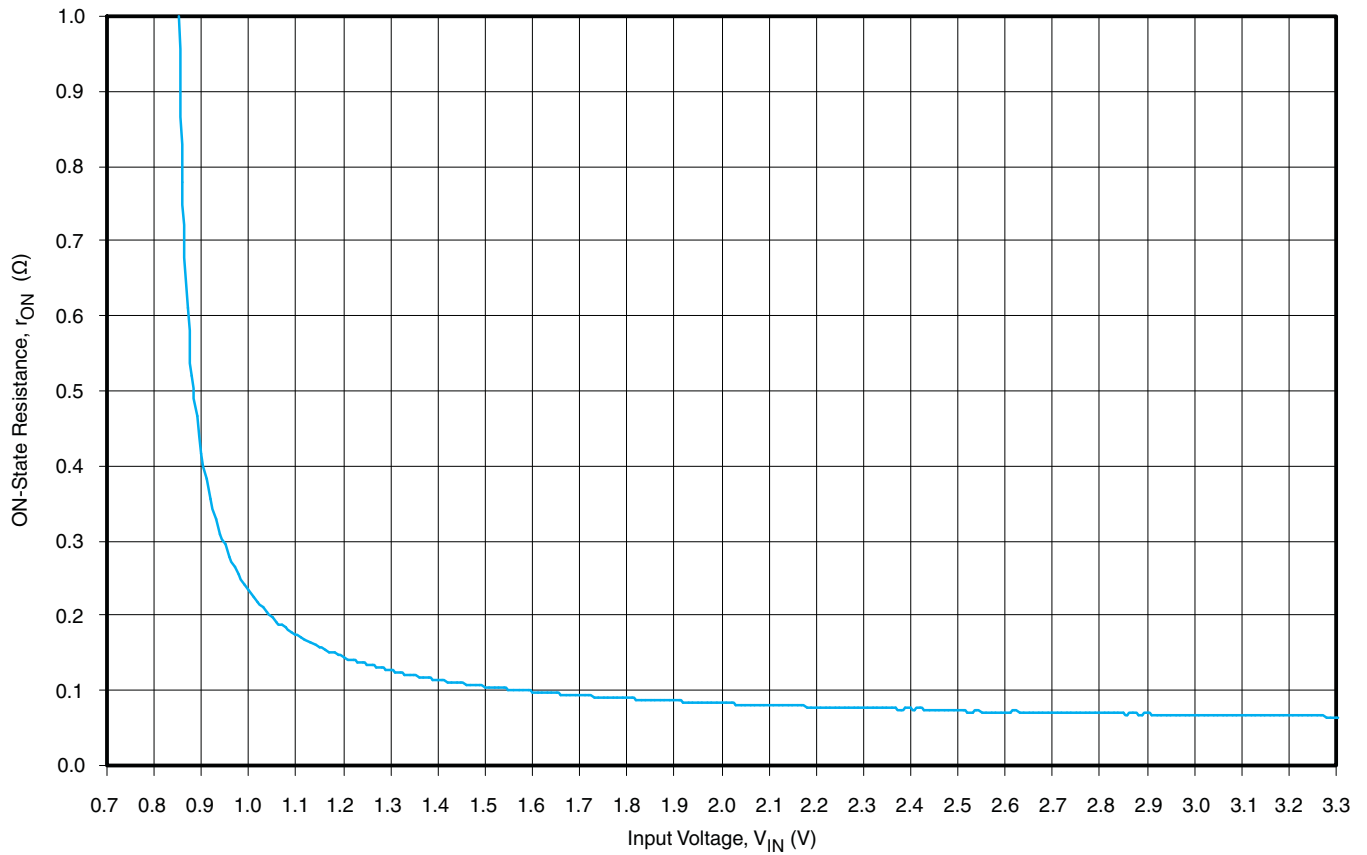

Figure 2. r_{ON} vs V_{IN}

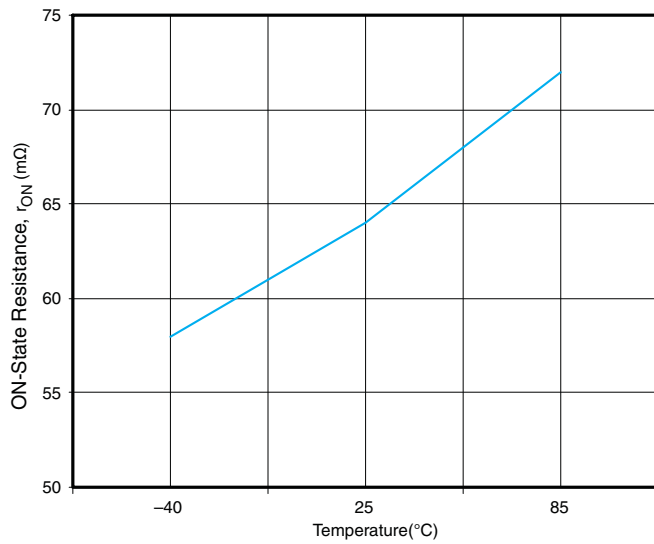

Figure 3. r_{ON} vs Temperature ($V_{IN} = 3.3$ V)

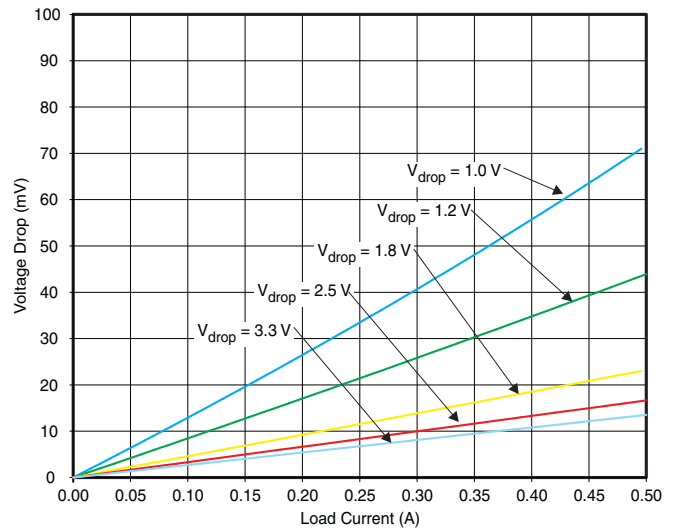

Figure 4. Voltage Drop vs. Load Current

TYPICAL CHARACTERISTICS (continued)

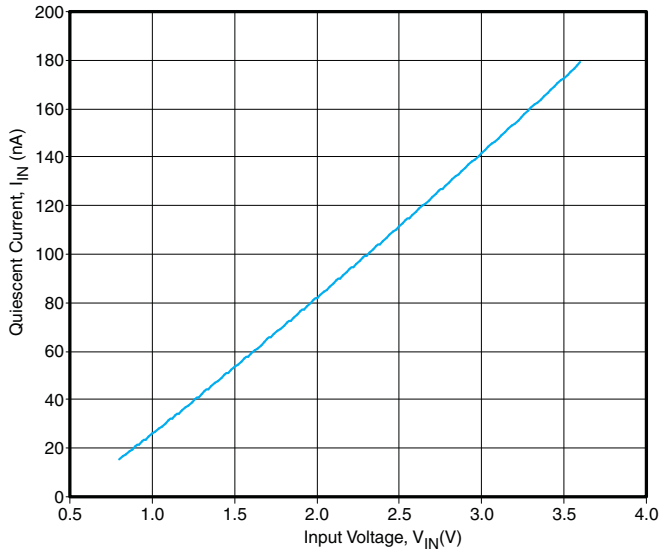

Figure 5. Quiescent Current vs V_{IN} ($V_{ON} = V_{IN}$, $I_{OUT} = 0$)

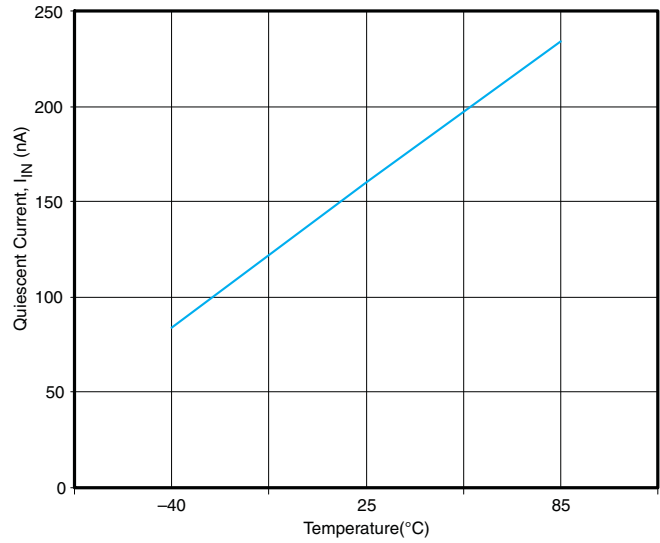

Figure 6. Quiescent Current vs Temperature ($V_{IN} = 3.3$ V, $I_{OUT} = 0$)

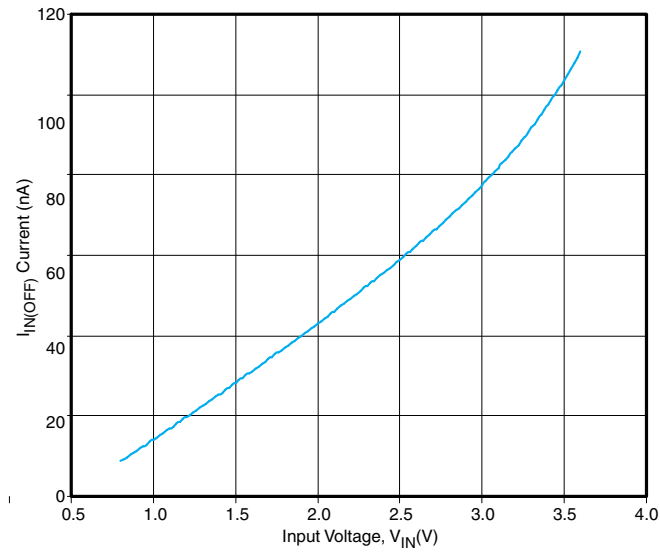

Figure 7. $I_{IN(OFF)}$ vs V_{IN} ($V_{ON} = 0$ V)

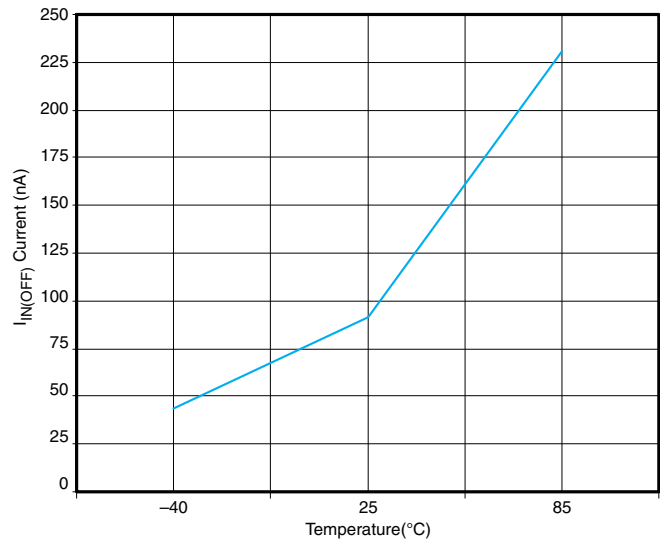

Figure 8. $I_{IN(OFF)}$ vs Temperature ($V_{IN} = 3.3$ V)

[查询 TPS22901 供应商](#)

TYPICAL CHARACTERISTICS (continued)

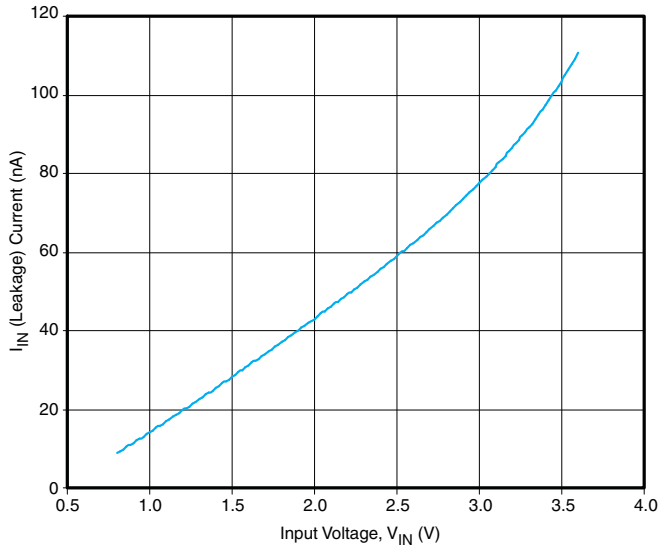

Figure 9. $I_{IN}(\text{Leakage})$ vs V_{IN} ($I_{OUT} = 0$)

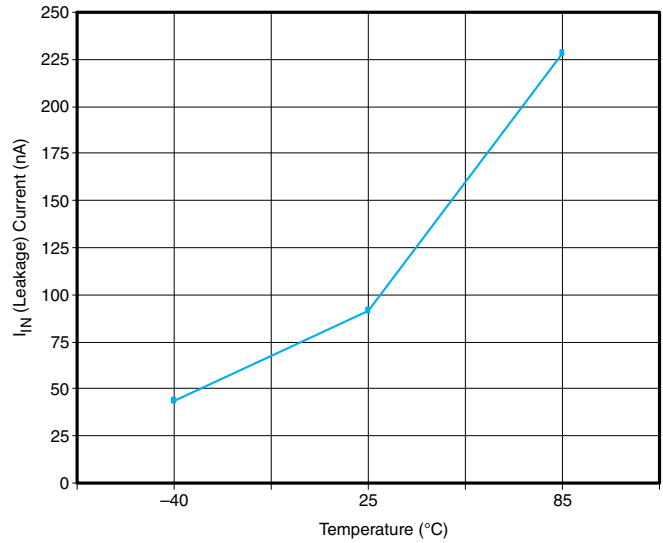

Figure 10. I_{IN} (Leakage) vs Temperature ($V_{IN} = 3.3$ V)

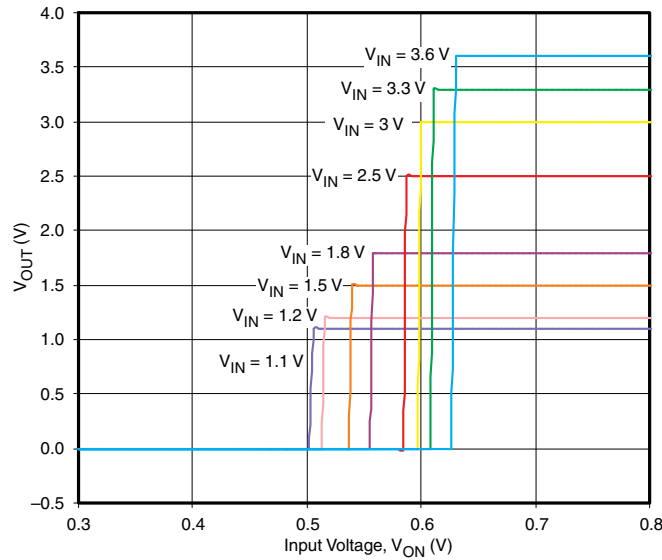

Figure 11. ON-Input Threshold

TYPICAL CHARACTERISTICS (continued)

TPS22901

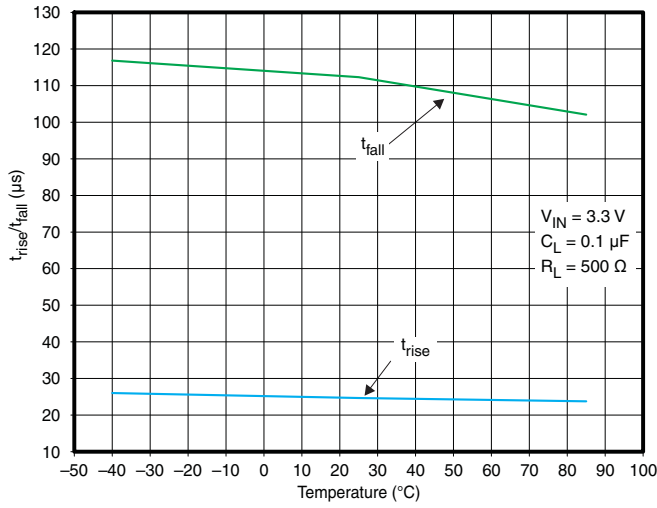

Figure 12. t_{rise}/t_{fall} vs Temperature

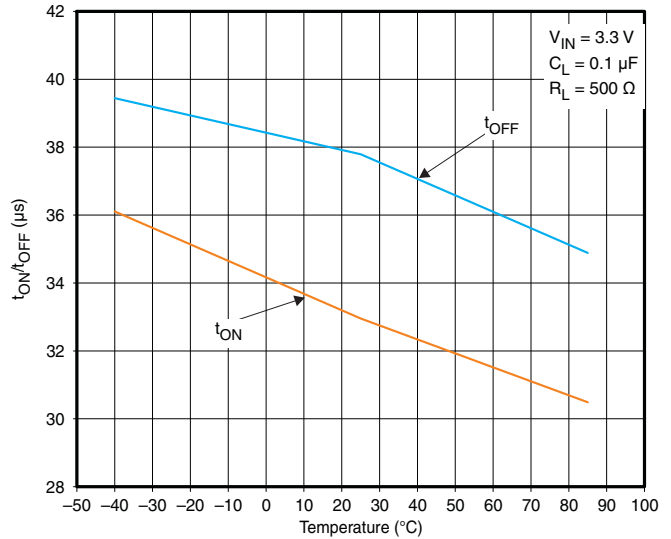

Figure 13. t_{ON}/t_{OFF} vs Temperature

TPS22902

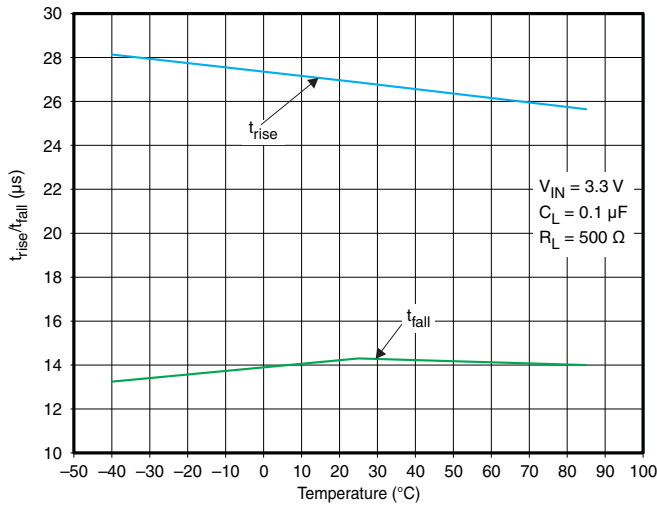

Figure 14. t_{rise}/t_{fall} vs Temperature

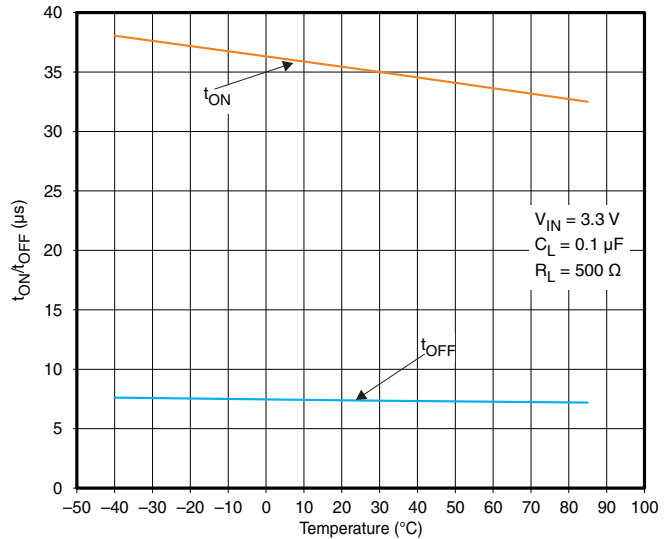

Figure 15. t_{ON}/t_{OFF} vs Temperature

[查询 TPS22901 供应商](#)

TYPICAL CHARACTERISTICS (continued)

TPS22902B

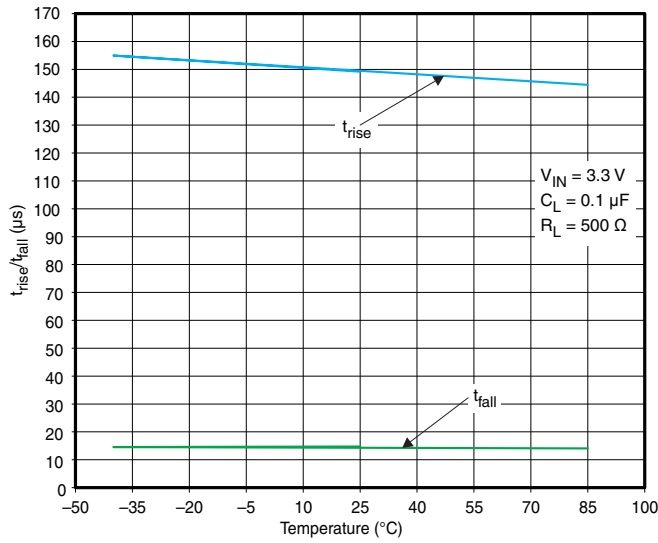

Figure 16. t_{rise}/t_{fall} vs Temperature

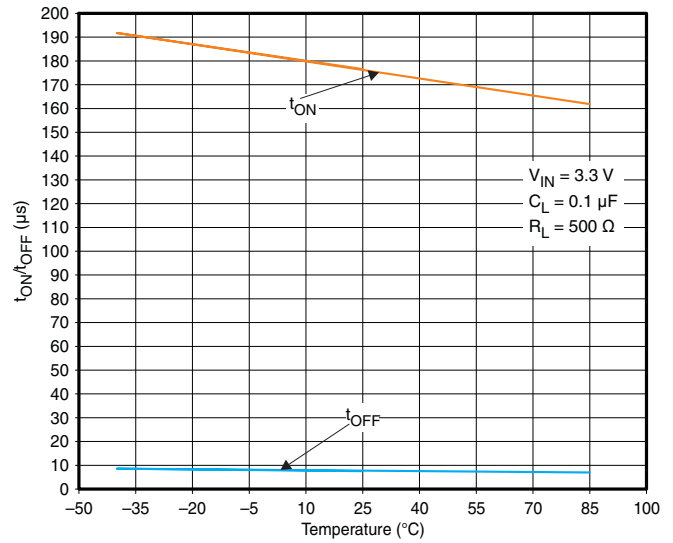

Figure 17. t_{ON}/t_{OFF} vs Temperature

TYPICAL CHARACTERISTICS (continued)

TPS22901 and TPS22902

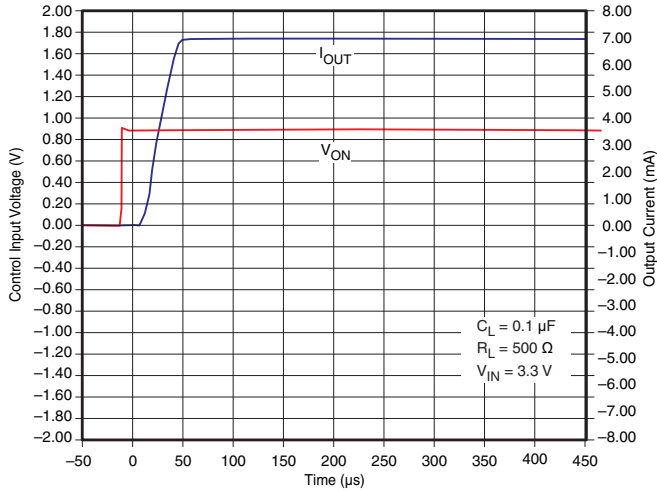

Figure 18. t_{ON} Response

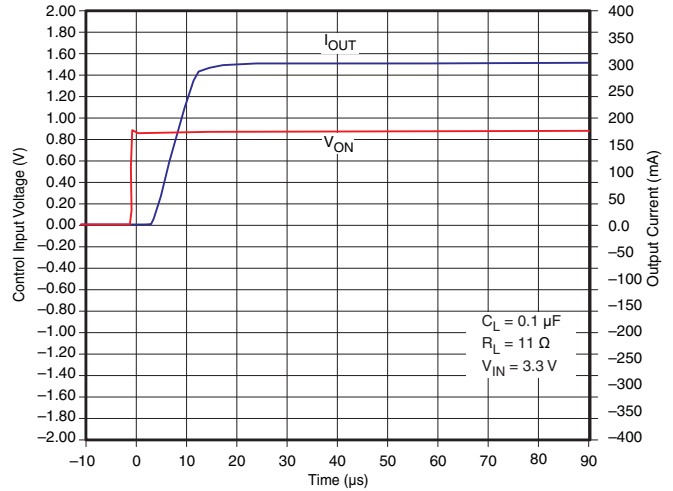

Figure 19. t_{ON} Response

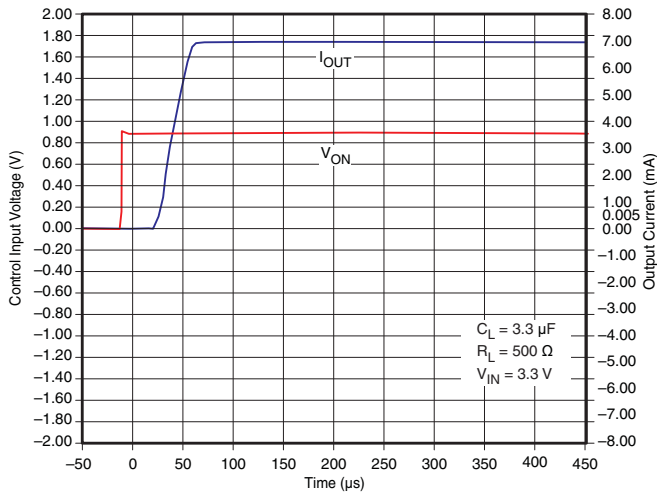

Figure 20. t_{ON} Response

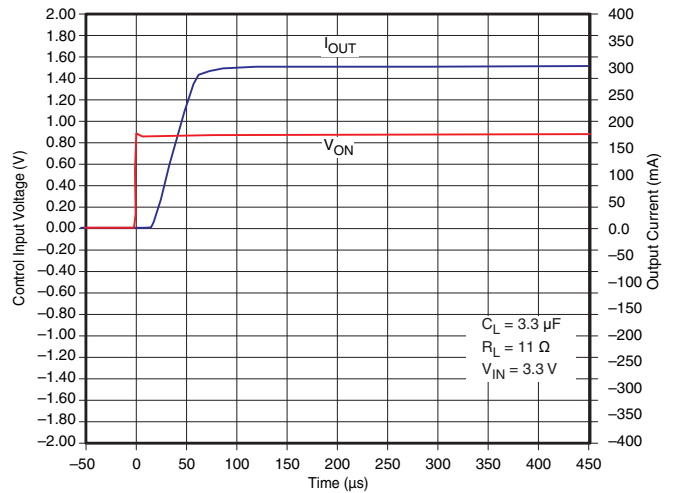

Figure 21. t_{ON} Response

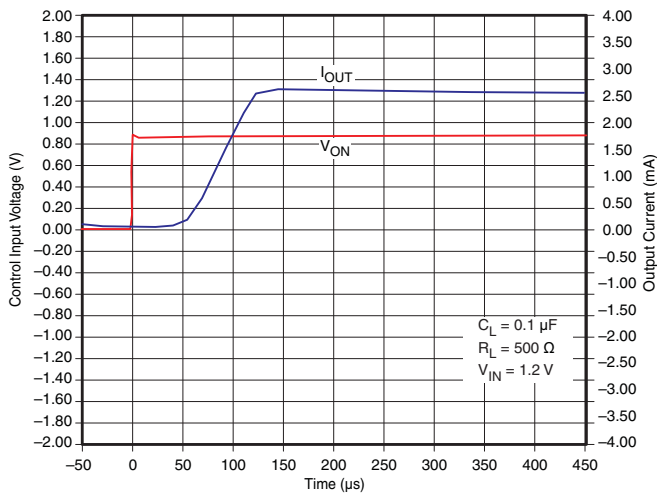

Figure 22. t_{ON} Response

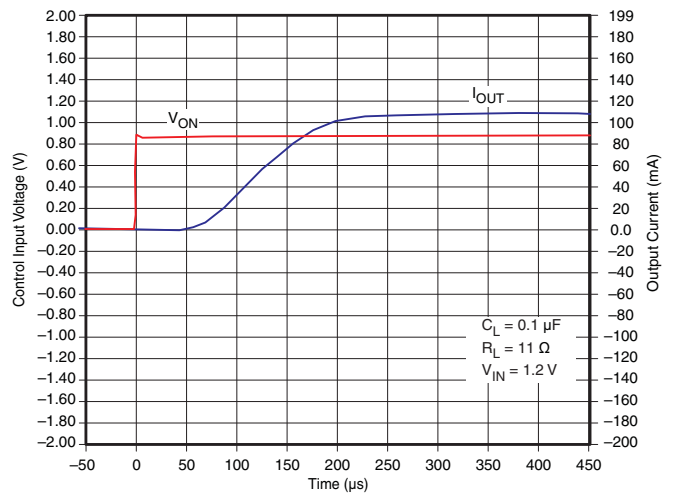

Figure 23. t_{ON} Response

[查询 TPS22901 供应商](#)

TYPICAL CHARACTERISTICS (continued)

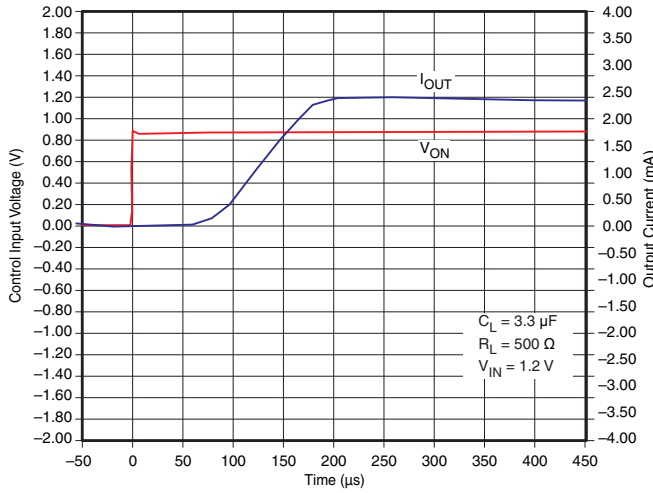

Figure 24. t_{ON} Response

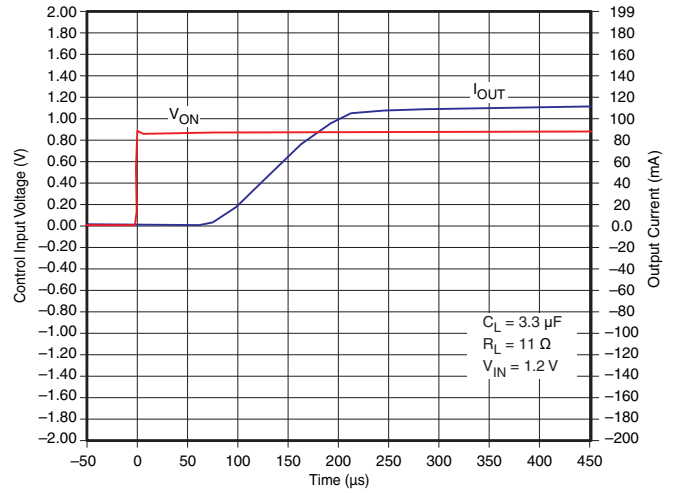

Figure 25. t_{ON} Response

TPS22901

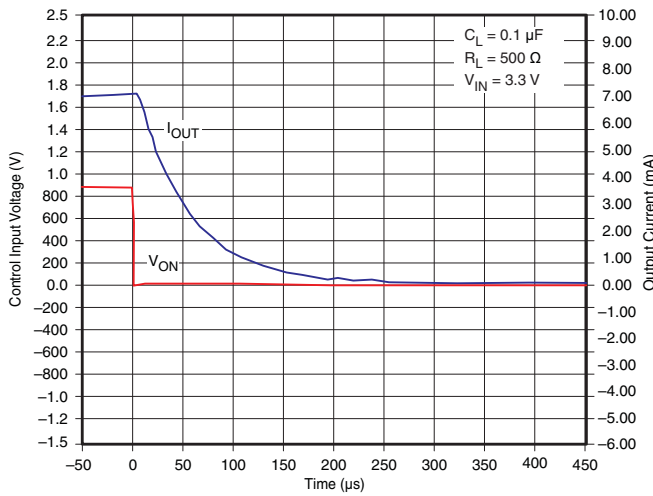

Figure 26. t_{OFF} Response

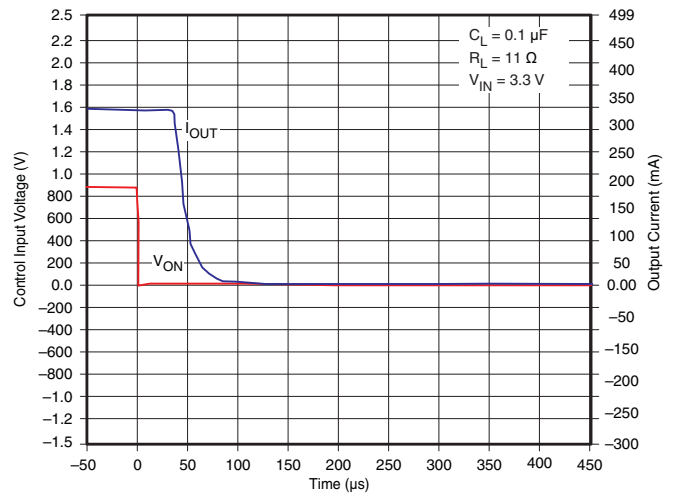

Figure 27. t_{OFF} Response

TYPICAL CHARACTERISTICS (continued)

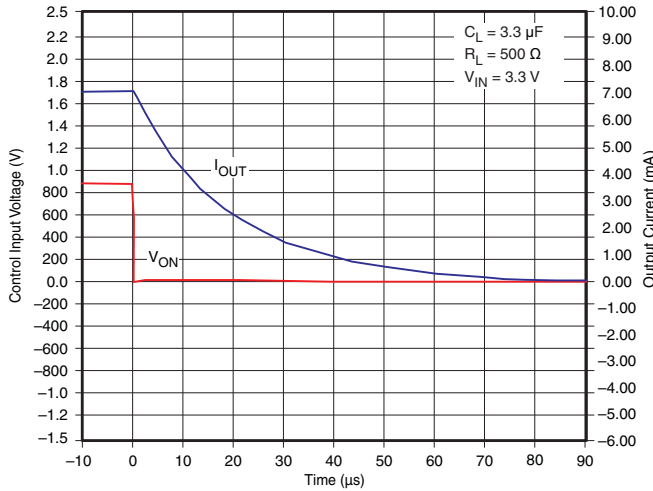

Figure 28. t_{OFF} Response

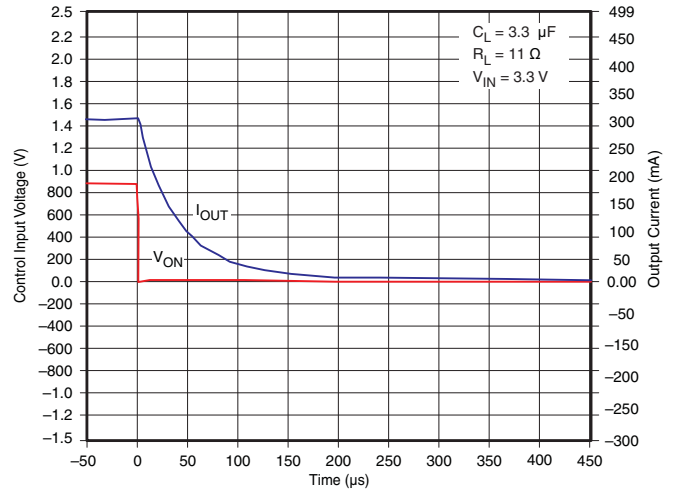

Figure 29. t_{OFF} Response

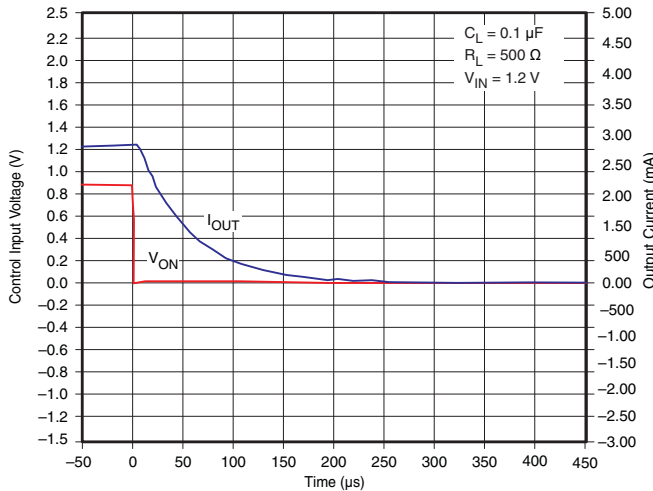

Figure 30. t_{OFF} Response

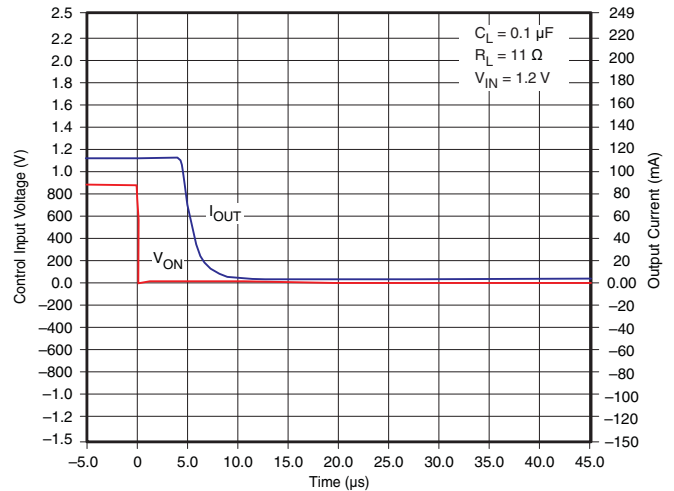

Figure 31. t_{OFF} Response

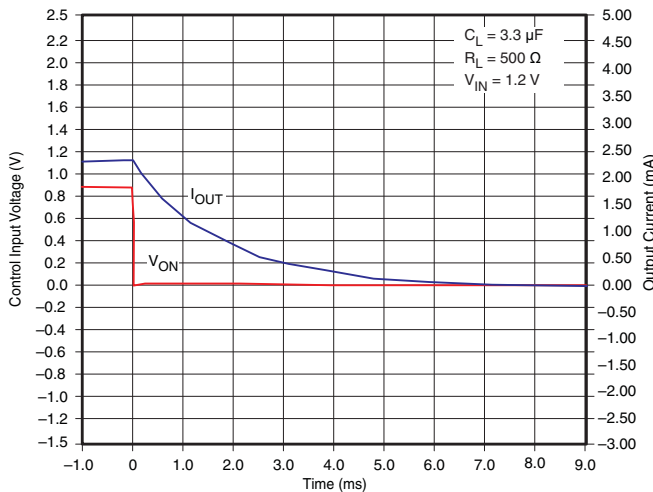

Figure 32. t_{OFF} Response

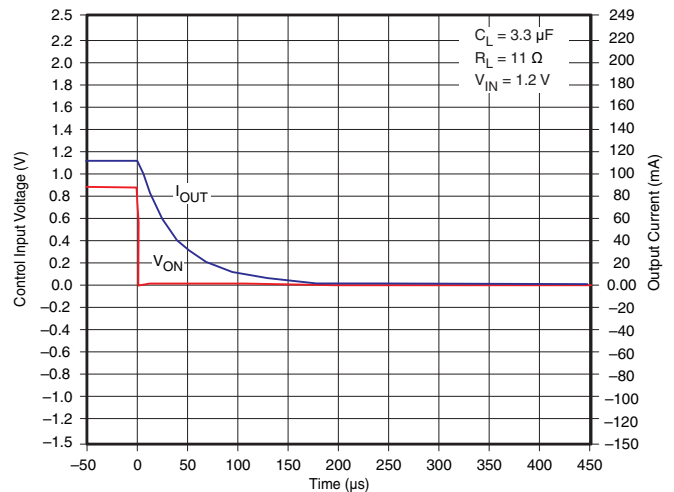

Figure 33. t_{OFF} Response

[查询 TPS22901 供应商](#)

TYPICAL CHARACTERISTICS (continued)

TPS22902

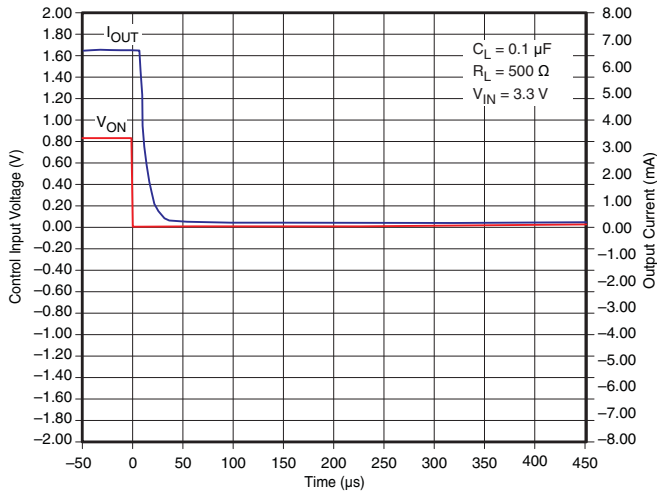

Figure 34. t_{OFF} Response

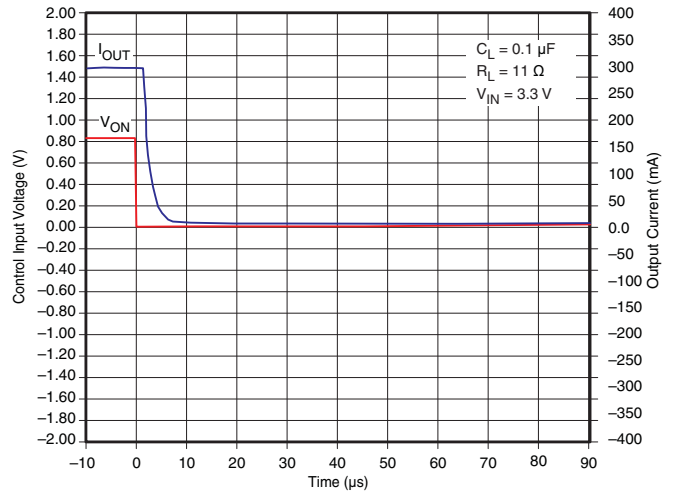

Figure 35. t_{OFF} Response

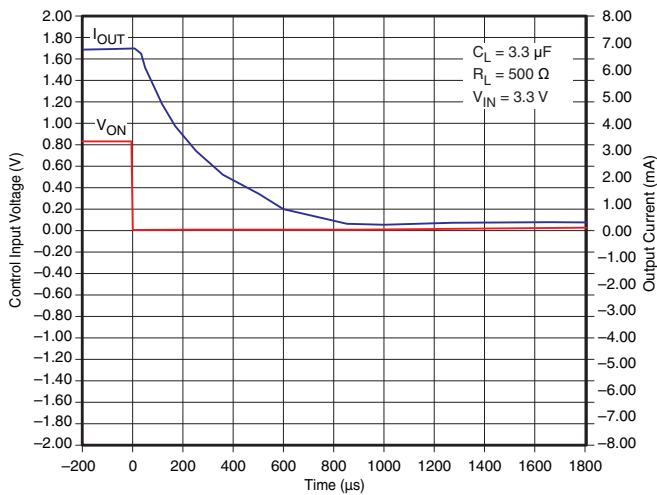

Figure 36. t_{OFF} Response

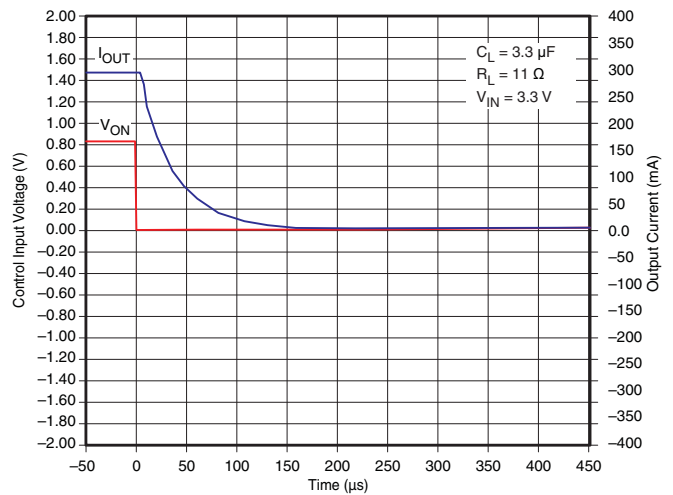

Figure 37. t_{OFF} Response

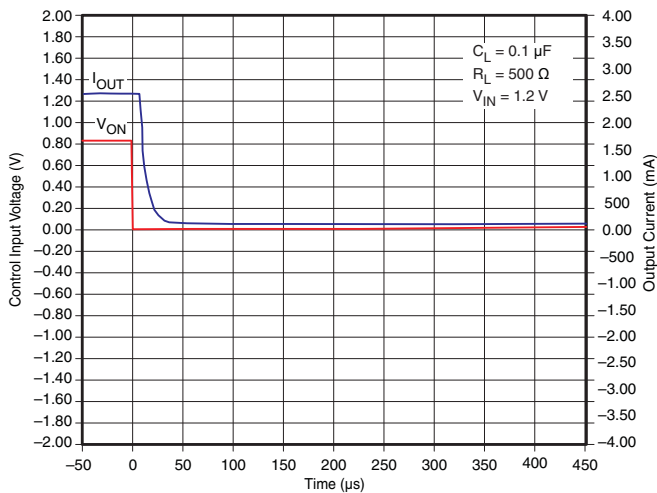

Figure 38. t_{OFF} Response

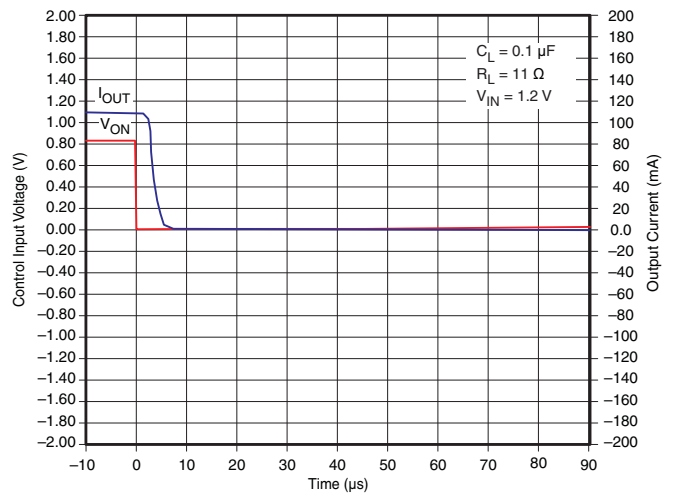

Figure 39. t_{OFF} Response

TYPICAL CHARACTERISTICS (continued)

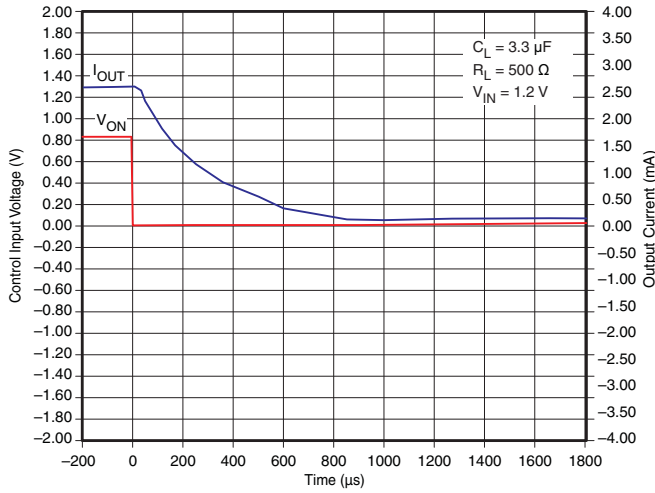

Figure 40. t_{OFF} Response

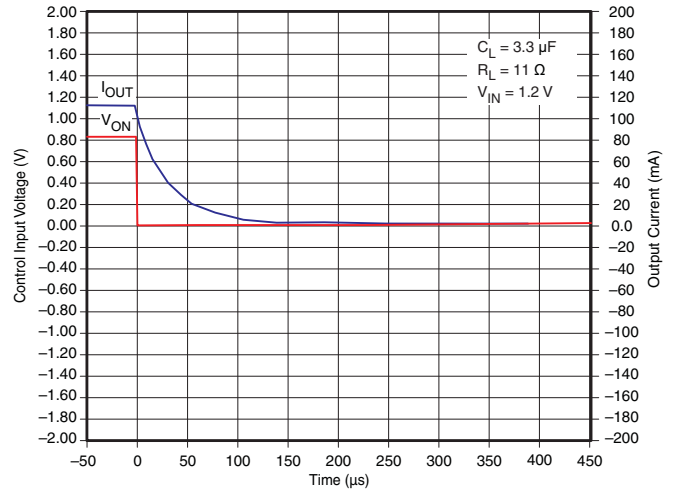

Figure 41. t_{OFF} Response

TPS22902B

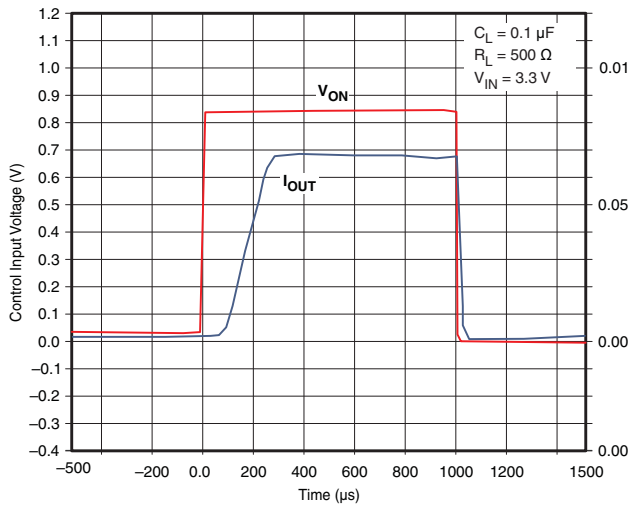

Figure 42. t_{ON} Response

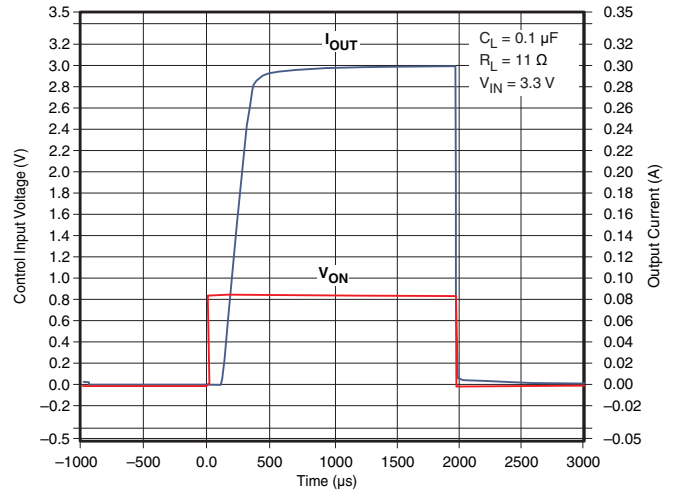

Figure 43. t_{ON} Response

查询 TPS22901 供应商

TYPICAL CHARACTERISTICS (continued)

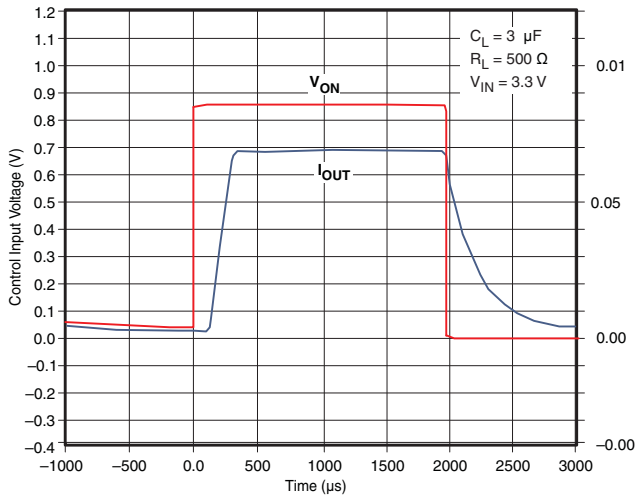

Figure 44. t_{ON} Response

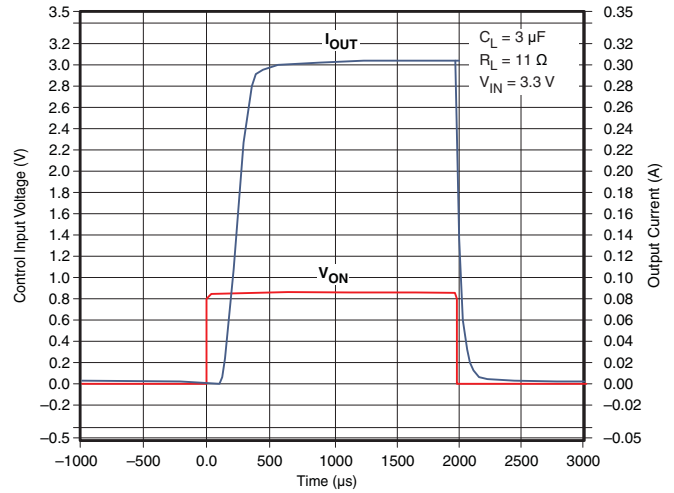

Figure 45. t_{ON} Response

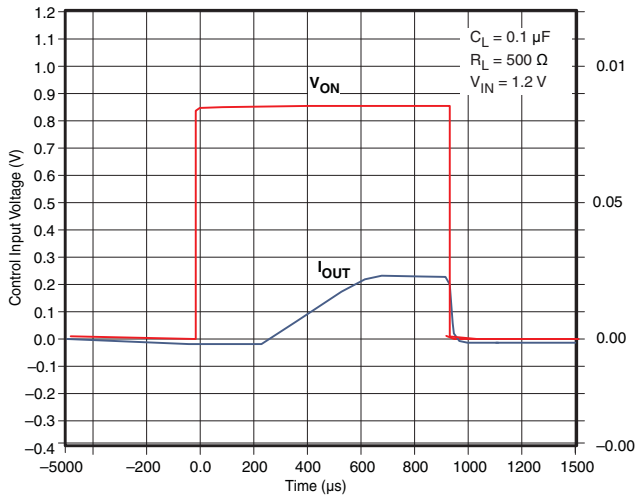

Figure 46. t_{ON} Response

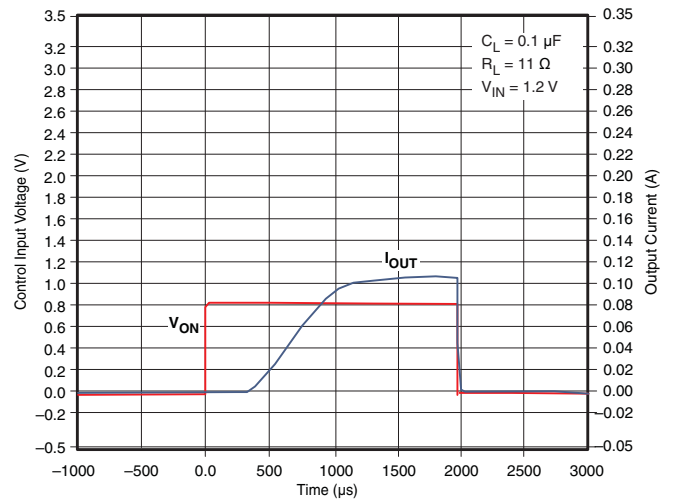

Figure 47. t_{ON} Response

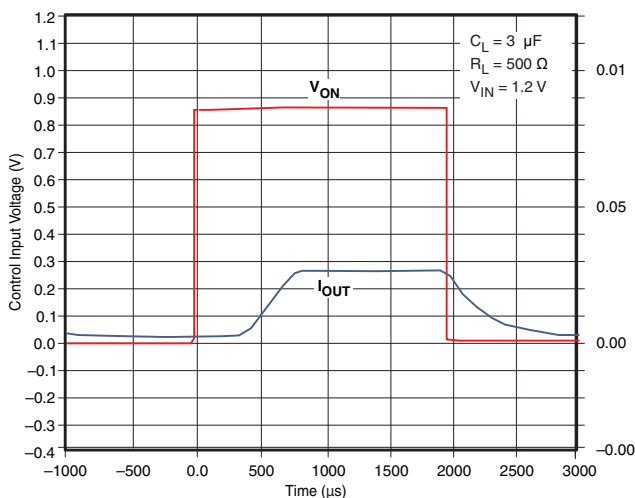

Figure 48. t_{ON} Response

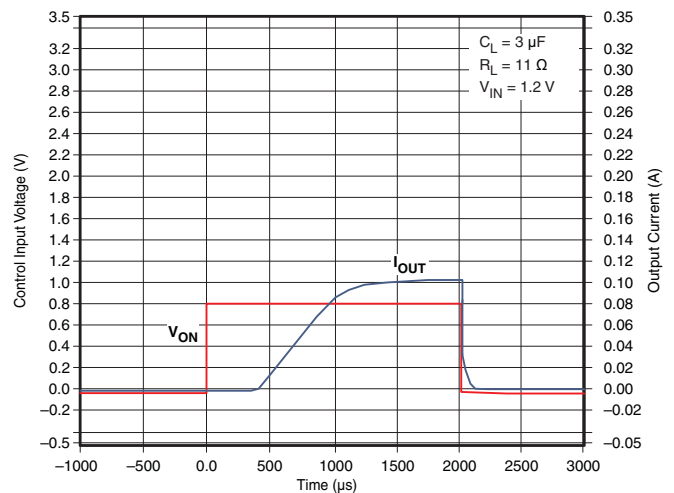

Figure 49. t_{ON} Response

TYPICAL CHARACTERISTICS (continued)

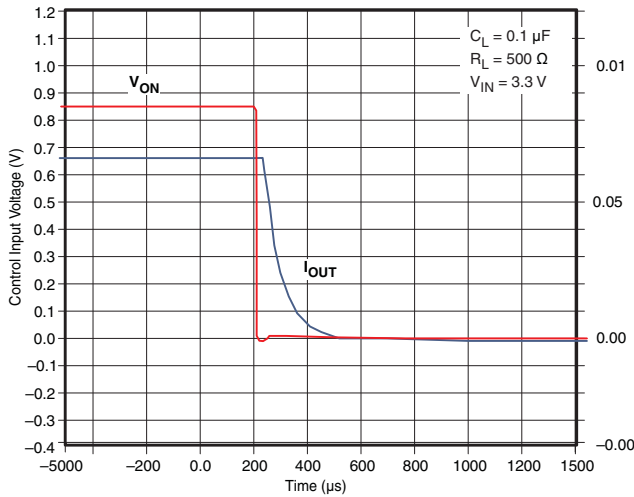

Figure 50. t_{OFF} Response

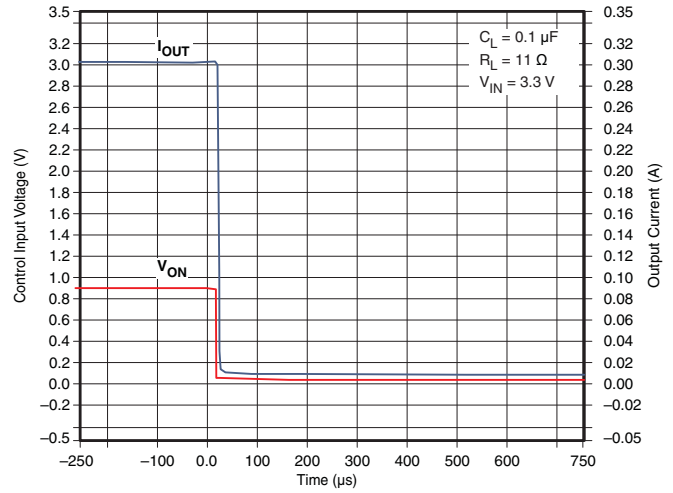

Figure 51. t_{OFF} Response

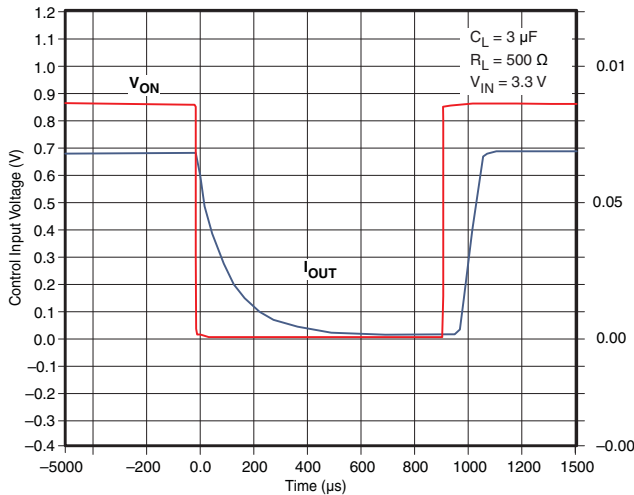

Figure 52. t_{OFF} Response

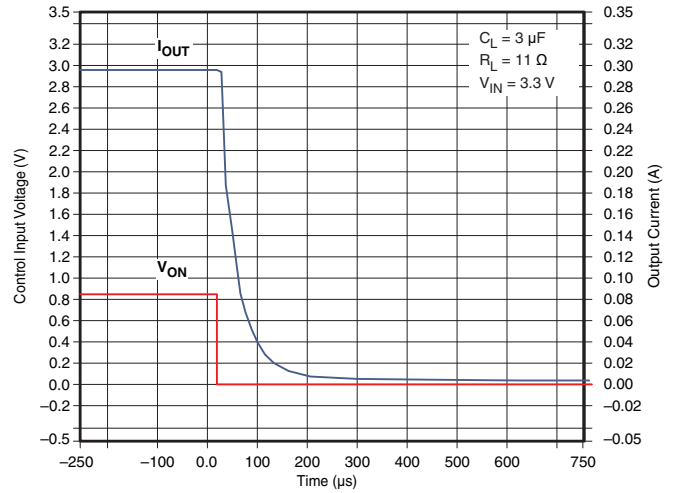

Figure 53. t_{OFF} Response

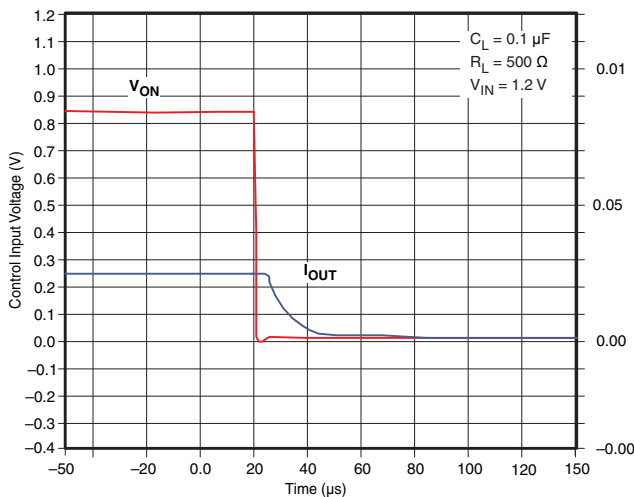

Figure 54. t_{OFF} Response

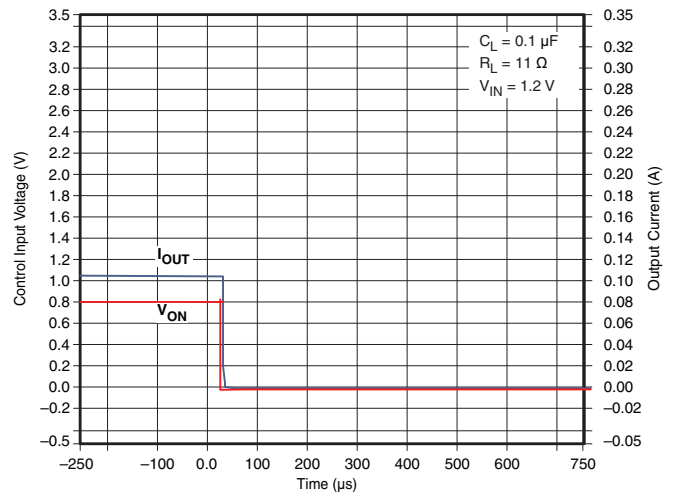

Figure 55. t_{OFF} Response

[查询 TPS22901 供应商](#)

TYPICAL CHARACTERISTICS (continued)

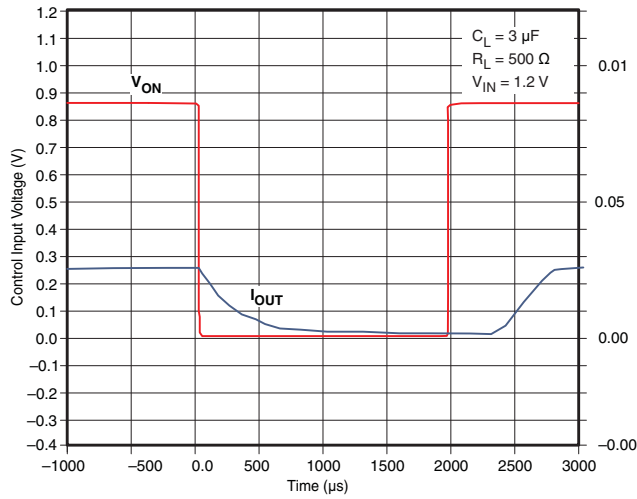

Figure 56. t_{OFF} Response

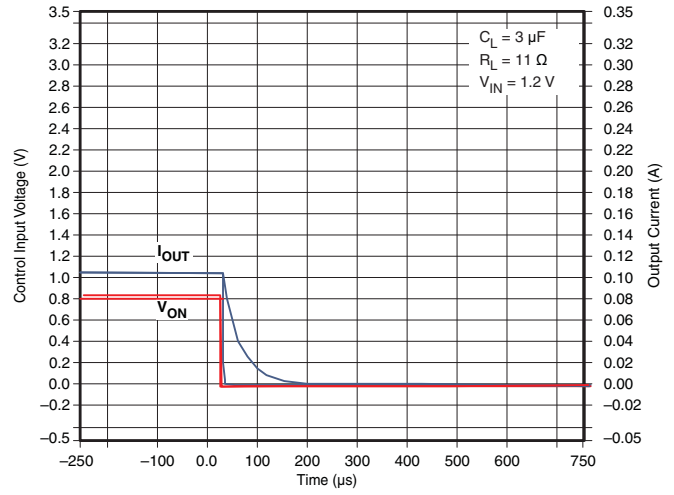
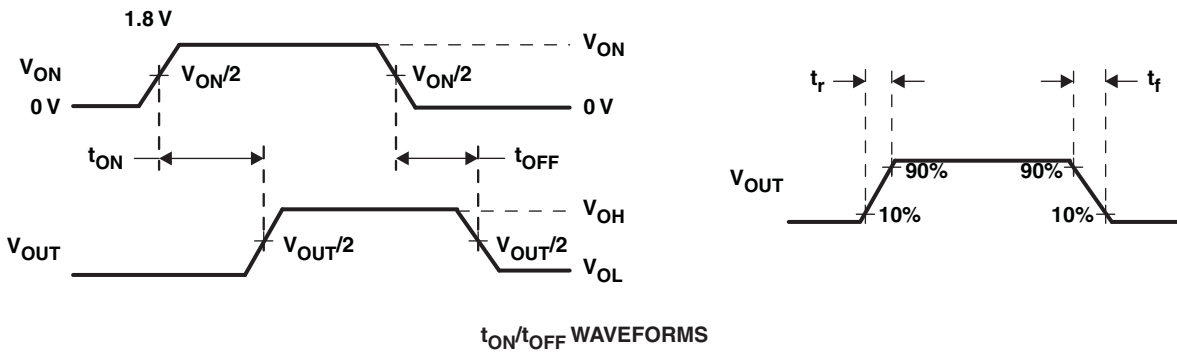
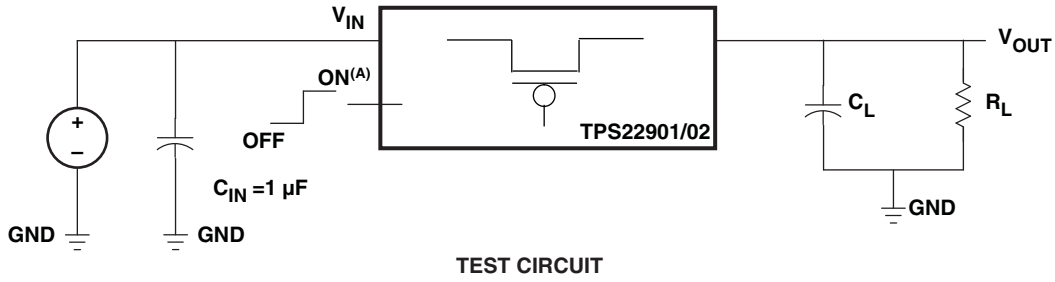

Figure 57. t_{OFF} Response

PARAMETER MEASUREMENT INFORMATION



A. t_{rise} and t_{fall} of the control signal is 100 ns.

Figure 58. Test Circuit and t_{ON}/t_{OFF} Waveforms

APPLICATION INFORMATION

ON/OFF Control

The ON pin controls the state of the switch. Activating ON continuously holds the switch in the on state so long as there is no fault. ON is active-high and has a low threshold, making it capable of interfacing with low voltage signals. The ON pin is compatible with standard GPIO logic threshold. It can be used with any microcontroller with 1.2-V, 1.8-V, 2.5-V or 3.3-V GPIOs.

Input Capacitor

To limit the voltage drop on the input supply caused by transient in-rush currents when the switch turns on into a discharged load capacitor or short-circuit, a capacitor needs to be placed between V_{IN} and GND. A 1- μ F ceramic capacitor, C_{IN} , placed close to the pins is usually sufficient. Higher values of C_{IN} can be used to further reduce the voltage drop during high current application. When switching heavy loads, it is recommended to have an input capacitor about 10 times higher than the output capacitor, this in order to avoid excessive voltage drop.

Output Capacitor

Due to the integral body diode in the PMOS switch, a C_{IN} greater than C_L is highly recommended. A C_L greater than C_{IN} can cause V_{OUT} to exceed V_{IN} when the system supply is removed. This could result in current flow through the body diode from V_{OUT} to V_{IN} .

Board Layout

For best performance, all traces should be as short as possible. To be most effective, the input and output capacitors should be placed close to the device to minimize the effects that parasitic trace inductances may have on normal and short-circuit operation. Using wide traces for V_{IN} , V_{OUT} , and GND helps minimize the parasitic electrical effects along with minimizing the case-to-ambient thermal impedance.

PACKAGING INFORMATION

Orderable Device	Status ⁽¹⁾	Package Type	Package Drawing	Pins	Package Qty	Eco Plan ⁽²⁾	Lead/Ball Finish	MSL Peak Temp ⁽³⁾
TPS22901YFPR	ACTIVE	DSBGA	YFP	4	3000	Green (RoHS & no Sb/Br)	SNAGCU	Level-1-260C-UNLIM
TPS22902BYFPR	ACTIVE	DSBGA	YFP	4	3000	Green (RoHS & no Sb/Br)	SNAGCU	Level-1-260C-UNLIM
TPS22902YFPR	ACTIVE	DSBGA	YFP	4	3000	Green (RoHS & no Sb/Br)	SNAGCU	Level-1-260C-UNLIM

⁽¹⁾ The marketing status values are defined as follows:

ACTIVE: Product device recommended for new designs.

LIFEBUY: TI has announced that the device will be discontinued, and a lifetime-buy period is in effect.

NRND: Not recommended for new designs. Device is in production to support existing customers, but TI does not recommend using this part in a new design.

PREVIEW: Device has been announced but is not in production. Samples may or may not be available.

OBSOLETE: TI has discontinued the production of the device.

⁽²⁾ Eco Plan - The planned eco-friendly classification: Pb-Free (RoHS), Pb-Free (RoHS Exempt), or Green (RoHS & no Sb/Br) - please check <http://www.ti.com/productcontent> for the latest availability information and additional product content details.

TBD: The Pb-Free/Green conversion plan has not been defined.

Pb-Free (RoHS): TI's terms "Lead-Free" or "Pb-Free" mean semiconductor products that are compatible with the current RoHS requirements for all 6 substances, including the requirement that lead not exceed 0.1% by weight in homogeneous materials. Where designed to be soldered at high temperatures, TI Pb-Free products are suitable for use in specified lead-free processes.

Pb-Free (RoHS Exempt): This component has a RoHS exemption for either 1) lead-based flip-chip solder bumps used between the die and package, or 2) lead-based die adhesive used between the die and leadframe. The component is otherwise considered Pb-Free (RoHS compatible) as defined above.

Green (RoHS & no Sb/Br): TI defines "Green" to mean Pb-Free (RoHS compatible), and free of Bromine (Br) and Antimony (Sb) based flame retardants (Br or Sb do not exceed 0.1% by weight in homogeneous material)

⁽³⁾ MSL, Peak Temp. -- The Moisture Sensitivity Level rating according to the JEDEC industry standard classifications, and peak solder temperature.

Important Information and Disclaimer: The information provided on this page represents TI's knowledge and belief as of the date that it is provided. TI bases its knowledge and belief on information provided by third parties, and makes no representation or warranty as to the accuracy of such information. Efforts are underway to better integrate information from third parties. TI has taken and continues to take reasonable steps to provide representative and accurate information but may not have conducted destructive testing or chemical analysis on incoming materials and chemicals. TI and TI suppliers consider certain information to be proprietary, and thus CAS numbers and other limited information may not be available for release.

In no event shall TI's liability arising out of such information exceed the total purchase price of the TI part(s) at issue in this document sold by TI to Customer on an annual basis.

TAPE AND REEL INFORMATION

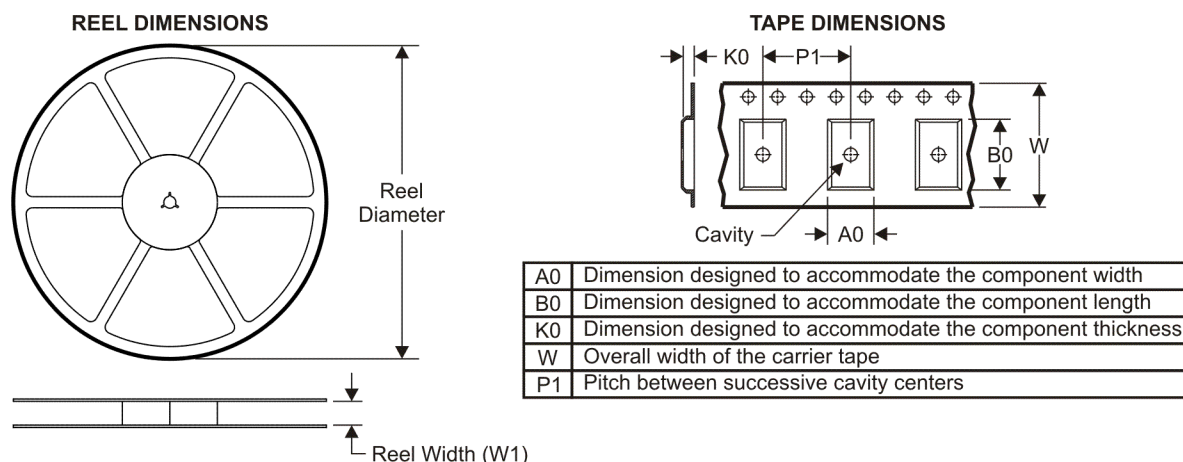

QUADRANT ASSIGNMENTS FOR PIN 1 ORIENTATION IN TAPE

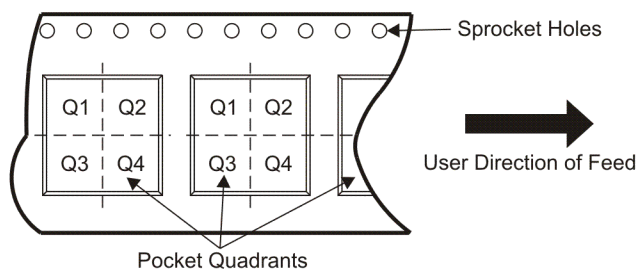

*All dimensions are nominal

Device	Package Type	Package Drawing	Pins	SPQ	Reel Diameter (mm)	Reel Width W1 (mm)	A0 (mm)	B0 (mm)	K0 (mm)	P1 (mm)	W (mm)	Pin1 Quadrant
TPS22901YFPR	DSBGA	YFP	4	3000	180.0	8.4	0.89	0.89	0.58	4.0	8.0	Q1

TAPE AND REEL BOX DIMENSIONS



*All dimensions are nominal

Device	Package Type	Package Drawing	Pins	SPQ	Length (mm)	Width (mm)	Height (mm)
TPS22901YFPR	DSBGA	YFP	4	3000	220.0	220.0	34.0

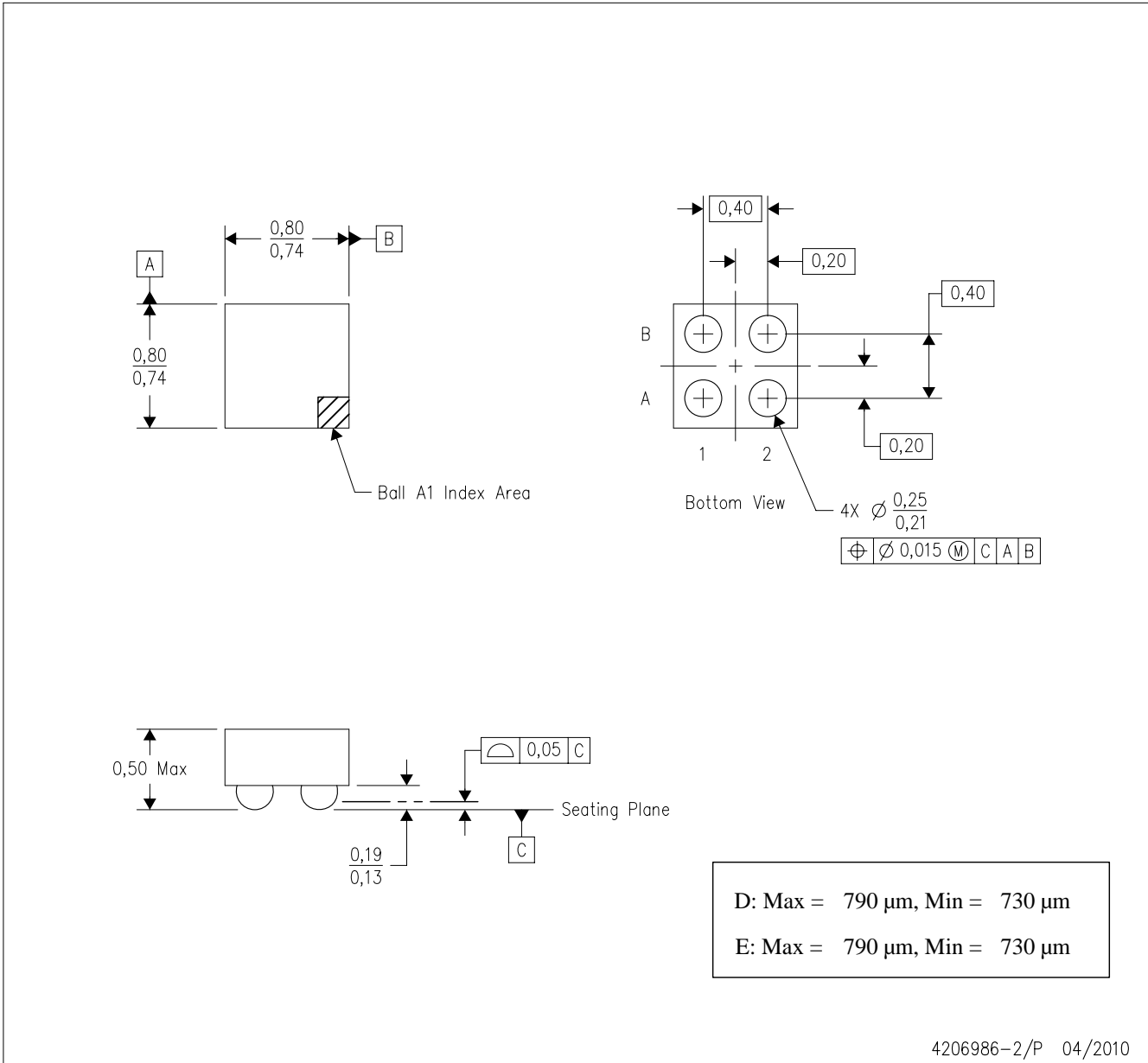

- NOTES:
- A. All linear dimensions are in millimeters. Dimensioning and tolerancing per ASME Y14.5M-1994.
 - B. This drawing is subject to change without notice.
 - C. NanoFree™ package configuration.
 - D. This is a Pb-free solder ball design.

IMPORTANT NOTICE

Texas Instruments Incorporated and its subsidiaries (TI) reserve the right to make corrections, modifications, enhancements, improvements, and other changes to its products and services at any time and to discontinue any product or service without notice. Customers should obtain the latest relevant information before placing orders and should verify that such information is current and complete. All products are sold subject to TI's terms and conditions of sale supplied at the time of order acknowledgment.

TI warrants performance of its hardware products to the specifications applicable at the time of sale in accordance with TI's standard warranty. Testing and other quality control techniques are used to the extent TI deems necessary to support this warranty. Except where mandated by government requirements, testing of all parameters of each product is not necessarily performed.

TI assumes no liability for applications assistance or customer product design. Customers are responsible for their products and applications using TI components. To minimize the risks associated with customer products and applications, customers should provide adequate design and operating safeguards.

TI does not warrant or represent that any license, either express or implied, is granted under any TI patent right, copyright, mask work right, or other TI intellectual property right relating to any combination, machine, or process in which TI products or services are used. Information published by TI regarding third-party products or services does not constitute a license from TI to use such products or services or a warranty or endorsement thereof. Use of such information may require a license from a third party under the patents or other intellectual property of the third party, or a license from TI under the patents or other intellectual property of TI.

Reproduction of TI information in TI data books or data sheets is permissible only if reproduction is without alteration and is accompanied by all associated warranties, conditions, limitations, and notices. Reproduction of this information with alteration is an unfair and deceptive business practice. TI is not responsible or liable for such altered documentation. Information of third parties may be subject to additional restrictions.

Resale of TI products or services with statements different from or beyond the parameters stated by TI for that product or service voids all express and any implied warranties for the associated TI product or service and is an unfair and deceptive business practice. TI is not responsible or liable for any such statements.

TI products are not authorized for use in safety-critical applications (such as life support) where a failure of the TI product would reasonably be expected to cause severe personal injury or death, unless officers of the parties have executed an agreement specifically governing such use. Buyers represent that they have all necessary expertise in the safety and regulatory ramifications of their applications, and acknowledge and agree that they are solely responsible for all legal, regulatory and safety-related requirements concerning their products and any use of TI products in such safety-critical applications, notwithstanding any applications-related information or support that may be provided by TI. Further, Buyers must fully indemnify TI and its representatives against any damages arising out of the use of TI products in such safety-critical applications.

TI products are neither designed nor intended for use in military/aerospace applications or environments unless the TI products are specifically designated by TI as military-grade or "enhanced plastic." Only products designated by TI as military-grade meet military specifications. Buyers acknowledge and agree that any such use of TI products which TI has not designated as military-grade is solely at the Buyer's risk, and that they are solely responsible for compliance with all legal and regulatory requirements in connection with such use.

TI products are neither designed nor intended for use in automotive applications or environments unless the specific TI products are designated by TI as compliant with ISO/TS 16949 requirements. Buyers acknowledge and agree that, if they use any non-designated products in automotive applications, TI will not be responsible for any failure to meet such requirements.

Following are URLs where you can obtain information on other Texas Instruments products and application solutions:

Products		Applications	
Amplifiers	amplifier.ti.com	Audio	www.ti.com/audio
Data Converters	dataconverter.ti.com	Automotive	www.ti.com/automotive
DLP® Products	www.dlp.com	Communications and Telecom	www.ti.com/communications
DSP	dsp.ti.com	Computers and Peripherals	www.ti.com/computers
Clocks and Timers	www.ti.com/clocks	Consumer Electronics	www.ti.com/consumer-apps
Interface	interface.ti.com	Energy	www.ti.com/energy
Logic	logic.ti.com	Industrial	www.ti.com/industrial
Power Mgmt	power.ti.com	Medical	www.ti.com/medical
Microcontrollers	microcontroller.ti.com	Security	www.ti.com/security
RFID	www.ti-rfid.com	Space, Avionics & Defense	www.ti.com/space-avionics-defense
RF/IF and ZigBee® Solutions	www.ti.com/lprf	Video and Imaging	www.ti.com/video
		Wireless	www.ti.com/wireless-apps