



### FEATURES

- RoHS compliant
- Inductance range from 0.25μH to 1.5μH
- Small footprint
- Ultra-low profile
- UL 94V-0 packaging materials
- Custom inductance values available

### PRODUCT OVERVIEW

The 3500 series is a range of flat-coil power inductors. They are ideal for high power designs which demand reliability in high temperature environments. Used to provide filtering or energy storage, they are suited to many power applications including portable devices, computers and telecom equipment.

### SELECTION GUIDE

Order Code	Inductance, L	DC Current <sup>2</sup>	DC Resistance
	±25% μH	Max. A	Max. mΩ
35251C	0.25	15.5	4.5
35501C	0.50	11.5	7.0
35801C	0.80	9.5	10
35112C	1.10	8.0	15
35152C	1.50	6.5	19

### ABSOLUTE MAXIMUM RATINGS

Operating free air temperature range	-40°C to 125°C
Storage temperature range	-40°C to 150°C

### SOLDERING INFORMATION<sup>1</sup>

Peak reflow solder temperature	250°C
Pin finish	Tin dip
Moisture sensitivity level	1

### PACKAGE SPECIFICATIONS

#### Mechanical Dimensions

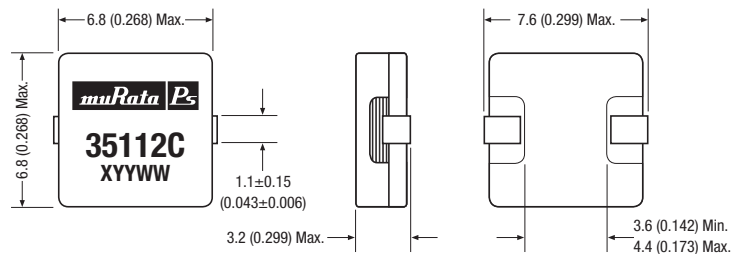

Package weight: 0.6g Typ.

#### Recommended Footprint Details

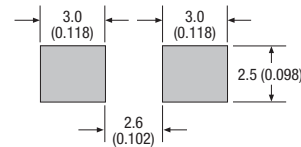

Unless otherwise stated, all dimensions in mm (inches) ± 0.25 (0.010).

Specifications typical at  $T_a = 25^\circ\text{C}$

1 For further information, please visit [www.murata-ps.com/rohs](http://www.murata-ps.com/rohs)

2 The maximum DC current is the value at which the inductance falls to 75% of its nominal value or when its temperature rise reaches 40°C, whichever is sooner.



**INDUCTANCE Vs CURRENT**

35152C  
 Typical performance characteristics

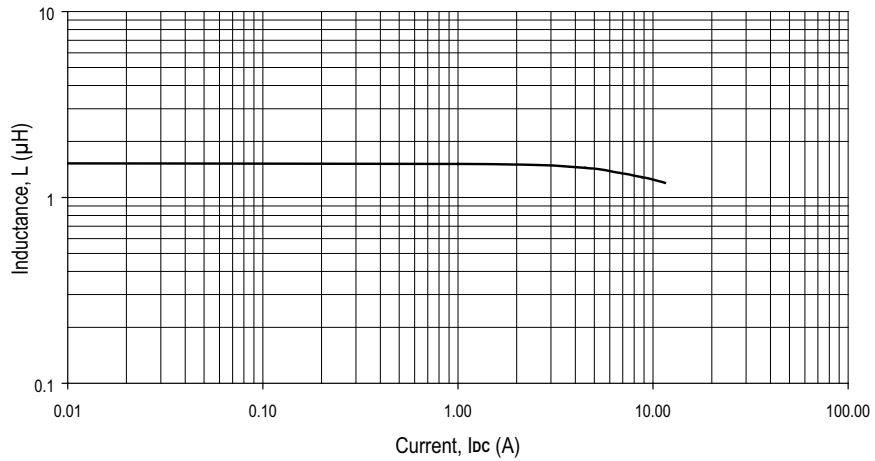

**TEMPERATURE Vs CURRENT**

35152C  
 Typical performance characteristics

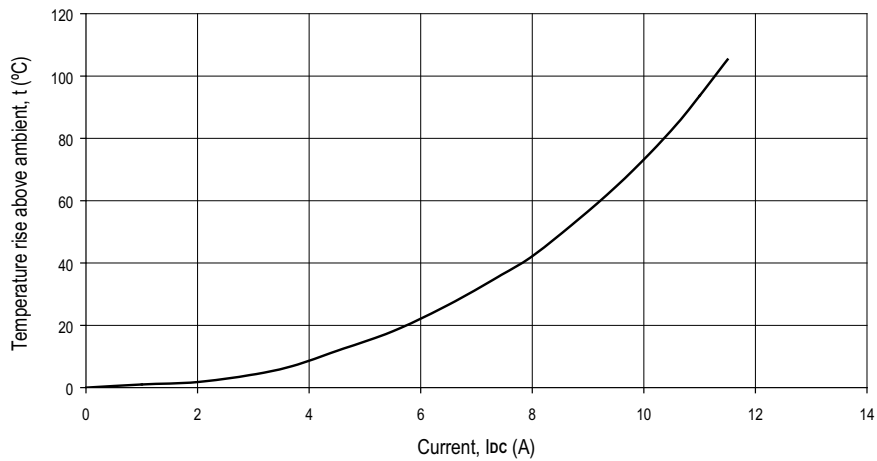

**INDUCTANCE Vs FREQUENCY**

35152C  
 Typical performance characteristics

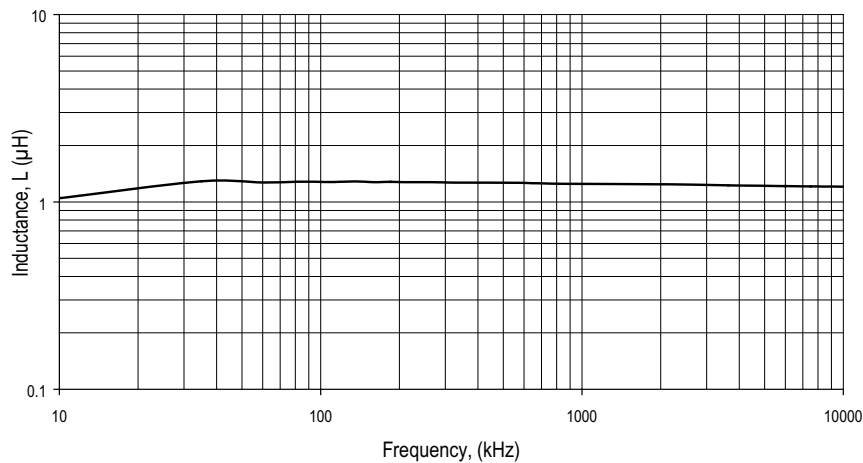

**PACKAGE SPECIFICATIONS**

**Mechanical Dimensions**

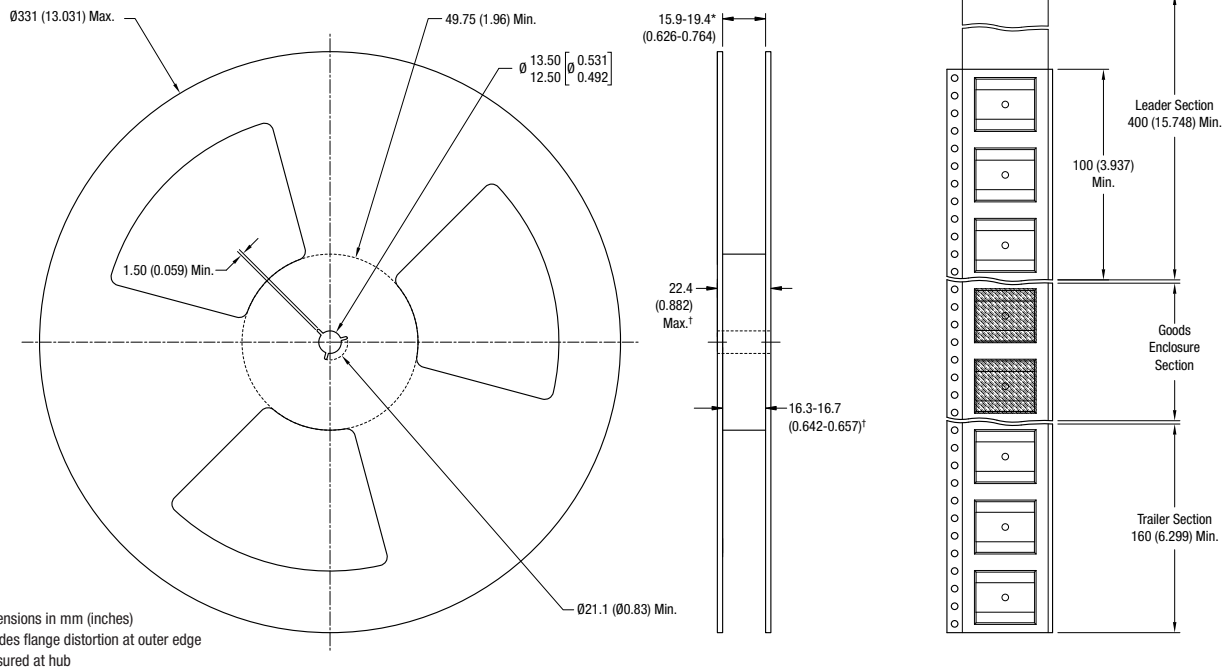

All dimensions in mm (inches)  
 \* Includes flange distortion at outer edge  
 † Measured at hub

**Tape Outline Dimensions**

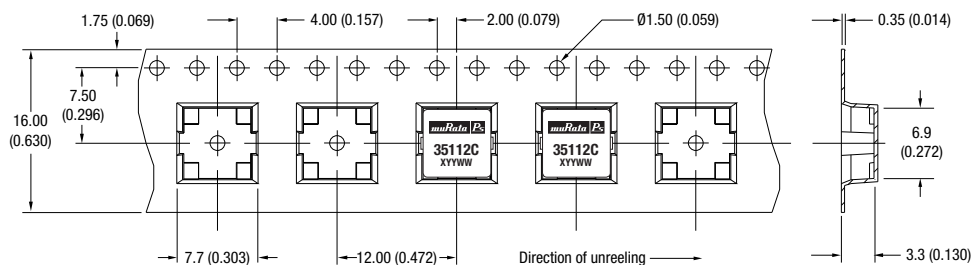

Reel quantity: 1400  
 Unless otherwise stated, all dimensions in mm (inches).