

查询"2SD1395"供应商

SANYO

No.1221C

2SD1395

NPN Triple Diffused Planar Silicon Darlington Transistor.

Driver Applications

Applications

- Suitable for use in switching of L load (motor drivers, printer hammer drivers, relay drivers).

Features

- High DC current gain.
- Large current capacity.
- Wide ASO.
- On-chip Zener diode of $60 \pm 10V$ between collector and base.
- Uniformity in collector-to-base breakdown voltage due to adoption of accurate impurity diffusion process.
- High inductive load handling capability.

Absolute Maximum Ratings at $T_a = 25^\circ C$

			unit
Collector-to-Base Voltage	V_{CB0}	50※	V
Collector-to-Emitter Voltage	V_{CEO}	50※	V
Emitter-to-Base Voltage	V_{EBO}	6	V
Collector Current	I_C	5	A
Collector Current (Pulse)	I_{CP}	8	A
Base Current	I_B	0.5	A
Collector Dissipation	P_C	40	W
Junction Temperature	T_j	150	$^\circ C$
Storage Temperature	T_{stg}	-55 to +150	$^\circ C$

 $T_c = 25^\circ C$ ※ : With Zener diode ($60 \pm 10V$)**Electrical Characteristics at $T_a = 25^\circ C$**

			min	typ	max	unit
Collector Cutoff Current	I_{CBO}	$V_{CB} = 40V, I_E = 0$			100	μA
Emitter Cutoff Current	I_{EBO}	$V_{EB} = 5V, I_C = 0$			3	mA
DC Current Gain	h_{FE}	$V_{CE} = 3V, I_C = 2.5A$	1000	4000		
Gain-Bandwidth Product	f_T	$V_{CE} = 5V, I_C = 2.5A$		20		MHz
C-E Saturation Voltage	$V_{CE(sat)}$	$I_C = 2.5A, I_B = 5mA$		0.9	1.5	V
B-E Saturation Voltage	$V_{BE(sat)}$	$I_C = 2.5A, I_B = 5mA$			2.0	V
C-B Breakdown Voltage	$V_{(BR)CBO}$	$I_C = 5mA, I_E = 0$	50	60	70	V
C-E Breakdown Voltage	$V_{(BR)CEO}$	$I_C = 50mA, R_{BE} = \infty$	50	60	70	V
Inductive Load Handling Capability	E_s/b	$L = 100mH, R_{BE} = 100\Omega$	50			mJ
Rise Time	t_{on}	$V_{CC} = 20V, I_C = 3.0A$ $I_{B1} = -I_{B2} = 6mA$		0.6		μs
Storage Time	t_{stg}			4.0		μs
Fall Time	t_f			1.5		μs

Package Dimensions 2010C

(unit : mm)

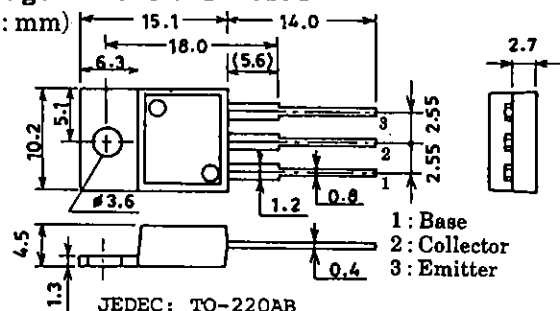
**SANYO Electric Co., Ltd. Semiconductor Business Headquarters**

TOKYO OFFICE Tokyo Bldg., 1-10, 1-Chome, Ueno, Taito-ku, TOKYO, 110 JAPAN

91096TS (KOTO) 8-5330/D251MH/5257KI/7223KI, MT No.1221-1/3

Specified Test Circuit

PW = 50μs, Duty Cycle ≤ 1%
 500I_{B1} = -500I_{B2} = I_C

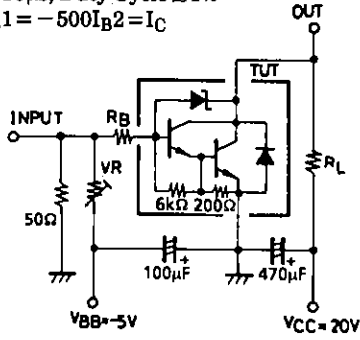

Es/b Test Circuit

V_{CC} = 20V, R_{BE} = 100Ω
 L = 100mH

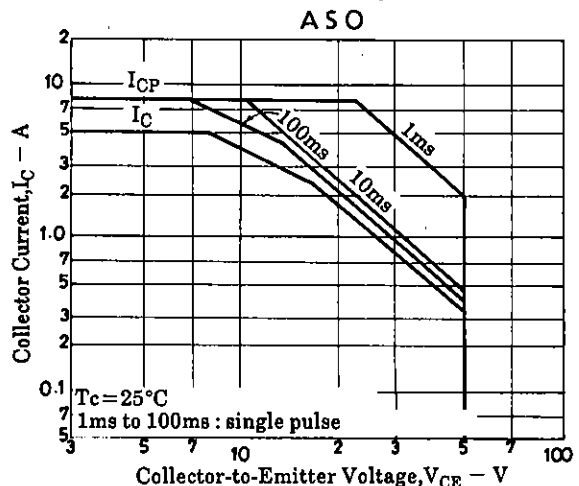
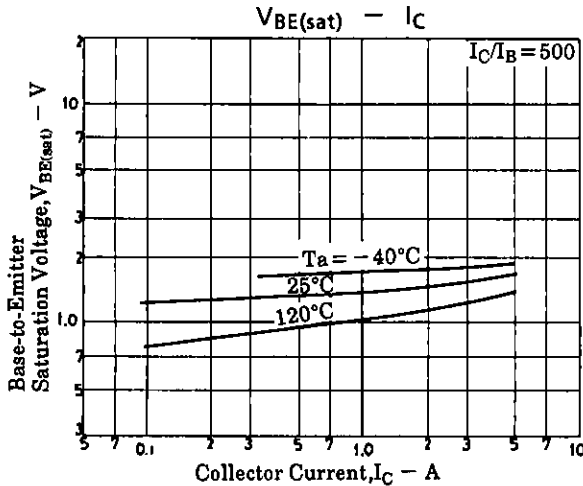
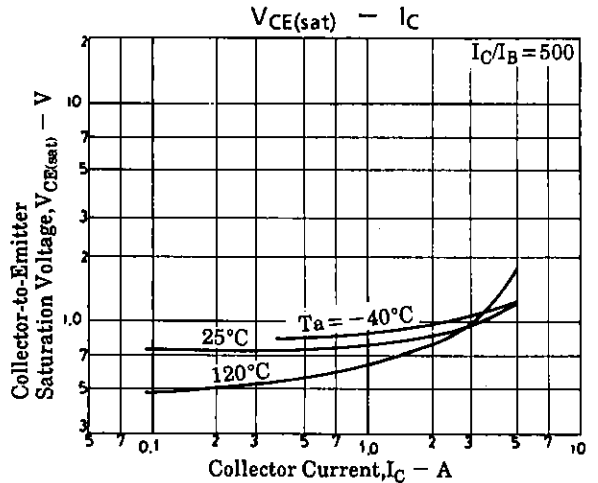
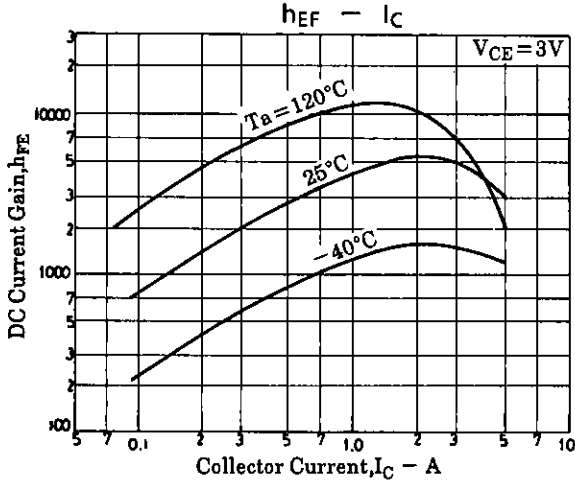
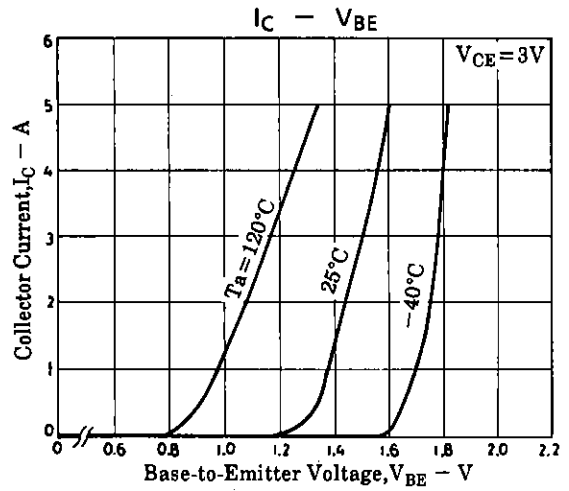
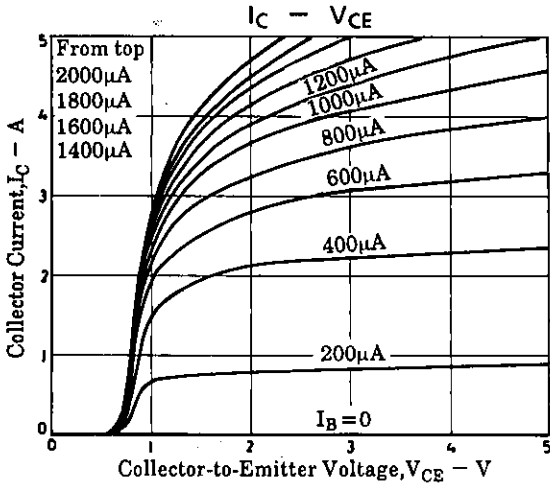
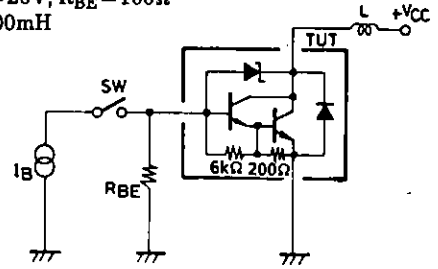

[查询"2SD1395"供应商](#)

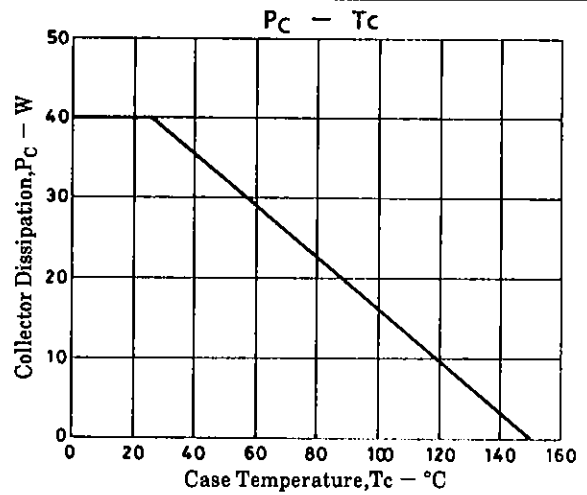
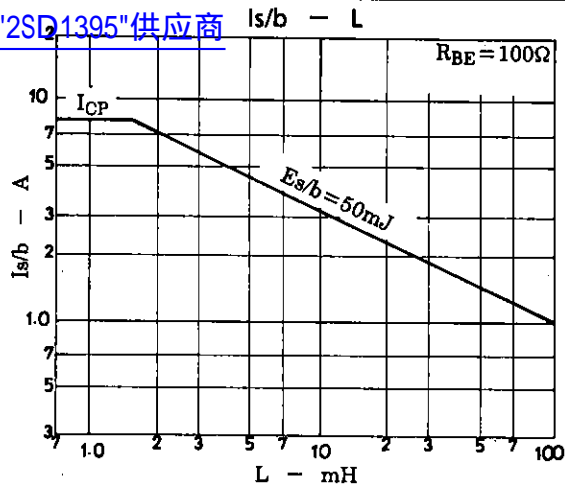

■ No products described or contained herein are intended for use in surgical implants, life-support systems, aerospace equipment, nuclear power control systems, vehicles, disaster/crime-prevention equipment and the like, the failure of which may directly or indirectly cause injury, death or property loss.

■ Anyone purchasing any products described or contained herein for an above-mentioned use shall:

- ① Accept full responsibility and indemnify and defend SANYO ELECTRIC CO., LTD., its affiliates, subsidiaries and distributors and all their officers and employees, jointly and severally, against any and all claims and litigation and all damages, cost and expenses associated with such use:
- ② Not impose any responsibility for any fault or negligence which may be cited in any such claim or litigation on SANYO ELECTRIC CO., LTD., its affiliates, subsidiaries and distributors or any of their officers and employees jointly or severally.

■ Information (including circuit diagrams and circuit parameters) herein is for example only; it is not guaranteed for volume production. SANYO believes information herein is accurate and reliable, but no guarantees are made or implied regarding its use or any infringements of intellectual property rights or other rights of third parties.

This catalog provides information as of September, 1996. Specifications and information herein are subject to change without notice.