

查询"NJM2294V"供应商

FM IF IC FOR PAGER

■ GENERAL DESCRIPTION

NJM2294 is a super low current FM IF IC for pagers. It includes almost all functions of the paging IF system. In those functions, the RSSI function can be used for automatic gain control. When the electric field strength is high, the RSSI output signal can control the attenuation of an RF amplifier to improve the received condition.

■ PACKAGE OUTLINE



NJM2294V

■ FEATURES

- Super low Operating Current (600 μ A)
- Low Operating Voltage (1.1~4.0V)
- RSSI (Received Signal Strength Indicator)
- FSK wave shaper
- Battery check alarm function (Alarm Voltage=1.1V typ.)
- Battery saving function
- A high output current voltage regulator with an external transistor (1.1V typ.)
- A ceramic discriminator is available.
- Package Outline SSOP16
- Bipolar Technology

■ RECOMMENDED OPERATIONAL CONDITION

- Operating Voltage V+ 1.1~4.0V

■ PIN CONFIGURATION

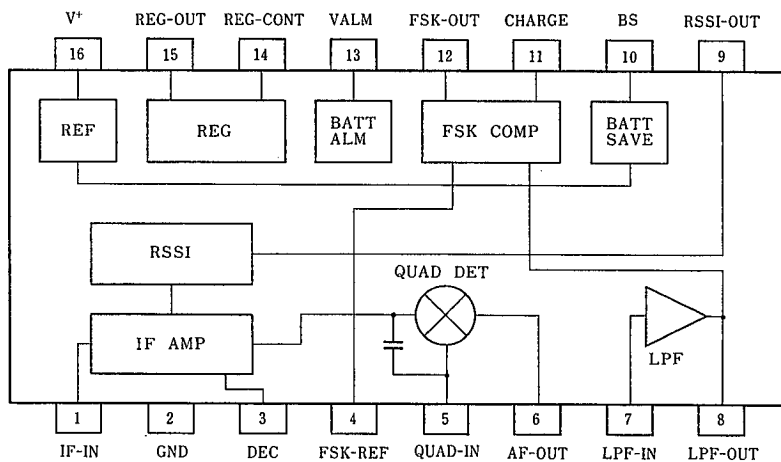

NJM2294V

[查询"NJM2294V"供应商](#)

■ MAXIMUM ABSOLUTE RATINGS

(Ta=25°C)

PARAMETER	SYMBOL	RATINGS	UNIT
Supply Voltage	V ⁺	5	V
Power Dissipation	P _d	300	mW
Operating Temperature Range	T _{opr}	-20~+75	°C
Storage Temperature Range	T _{stg}	-40~+125	°C

■ ELECTRICAL CHARACTERISTICS

(V⁺=14V, f_i=455kHz, f_{mod}=600Hz, f_{dev}=±4kHz, Ta=25°C)

PARAMETER	SYMBOL	TEST CIRCUIT	TEST CONDITION	MIN.	TYP.	MAX.	UNIT
No signal Operating Current	I _{ccq}	11	V _i = 0, 10pin = V ⁺	—	600	900	μA
Battery saving Operating Current	I _{ccs}	12	V _i = 0, 10pin = GND	—	0	5	μA
IF amplifier input resistance	R _{in}	—		—	2	—	kΩ
S/N 1	S/N1	1	V _i = 60dBμEMF	—	62	—	dB
S/N 2	S/N2	1	V _i = 25dBμEMF	—	35	—	dB
-3dB limiting sensitivity	V _{in(lim)}	1		—	22	27	dBμEMF
Demodulated output level	V _{od}	1	V _i = 60dBμEMF	30	46	65	mVrms
AM rejection ratio	AMR	1	V _i = 60dBμEMF, AM = 30%	—	50	—	dB
Duty ratio of wave shaped output	DR	2	V _i = 60dBμEMF	40	50	60	%
RSSI output voltage	V _{rssi}	10	V _i = 80dBμEMF	0.48	0.62	0.76	V
RSSI output resistance	R _{rssi}	—		—	62	—	kΩ
Quick charge/discharge current	I _{ch}	13	4pin = GND, 8pin = 0.18V	35	65	110	μA
Alarm voltage	V _{alm}	3		1.05	1.10	1.15	V
Regulator output voltage	V _{reg}	8	R _L = 430Ω	0.95	1.00	1.05	V
Low level output voltage of VALM terminal	V _{almL}	4	I _L = 100μA	—	0.1	0.4	V
High level leak current of VALM terminal	I _{almH}	5		—	0	2	μA
Low level output voltage of FSK-OUT terminal	V _{fskL}	6	I _L = 100μA	—	0.1	0.4	V
High level leak current of FSK-OUT terminal	I _{fskH}	7		—	0	2	μA
Low level output voltage of REG-CONT terminal	V _{regL}	9	I _L = 100μA	—	—	0.6	V

查询"NJM2294V"供应商

■ TEST CIRCUIT

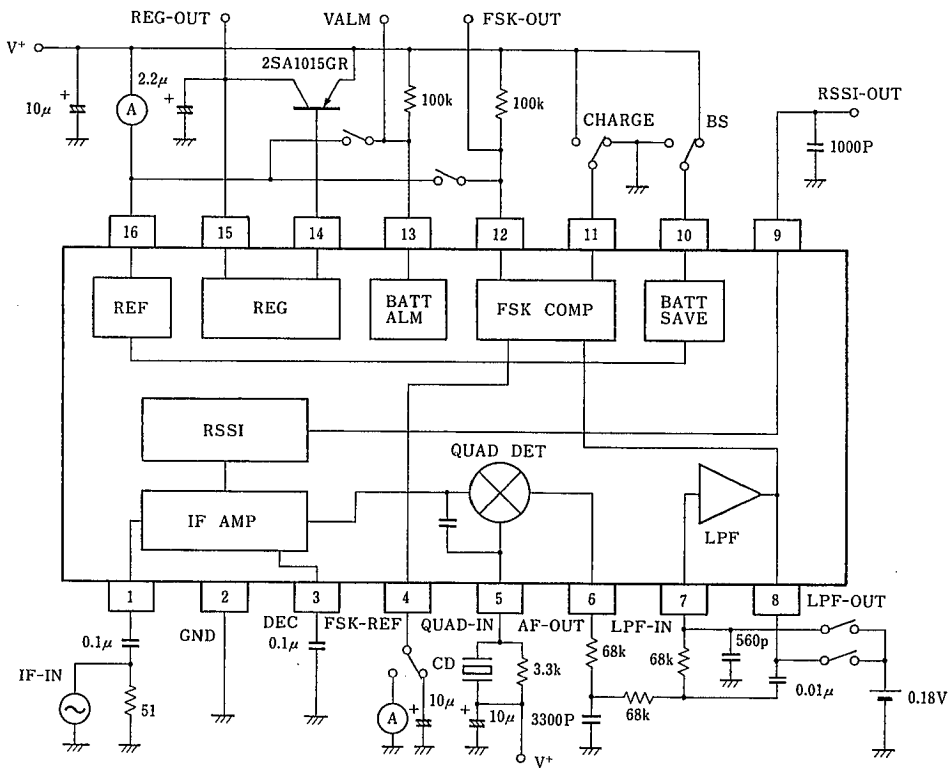

CD:CDBC455CX (MURATA MFG.)

Test Circuit 1

SN1, SN2, Vi (LIM), Vod, AMR

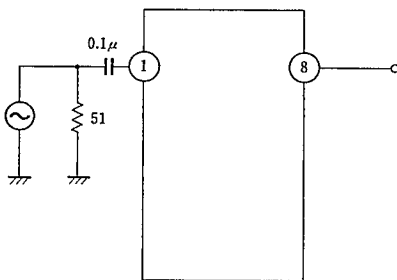

Test Circuit 2

DR

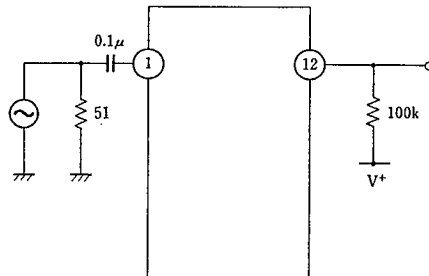

[查询"NJM2294V"供应商](#)

Test Circuit 3

Valm

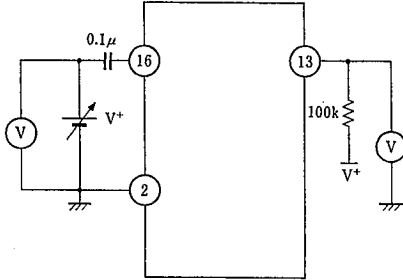

Test Circuit 4

ValmL

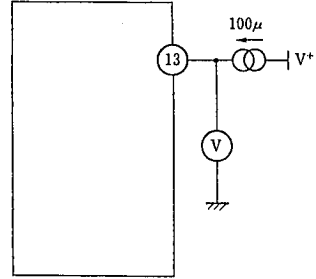

Test Circuit 5

IalmH

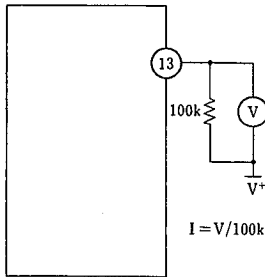

Test Circuit 6

VfskL

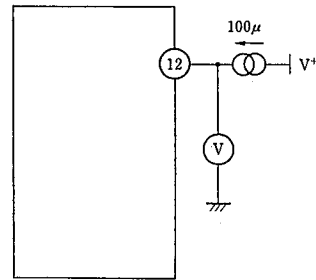

Test Circuit 7

IfskH

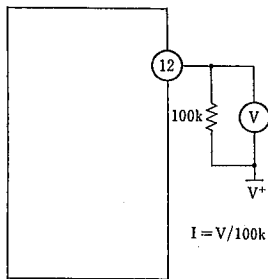

Test Circuit 8

Vreg

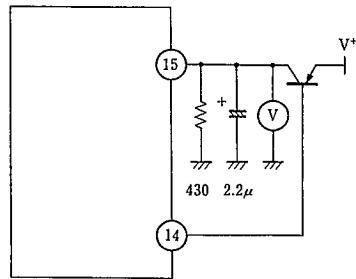

4

[查询"NJM2294V"供应商](#)

Test Circuit 9

VregL

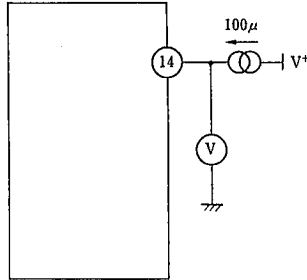

Test Circuit 10

Vrssi

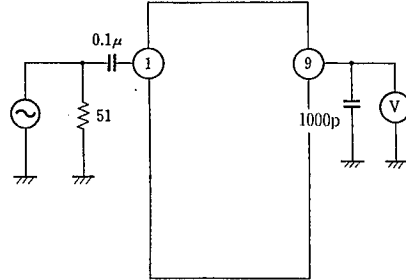

Test Circuit 11

Iccq

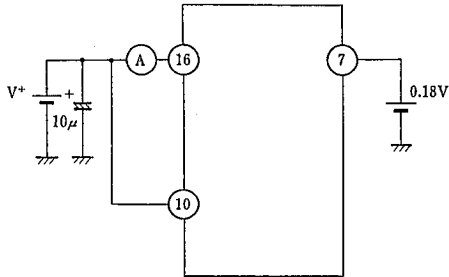

Test Circuit 12

Iccs

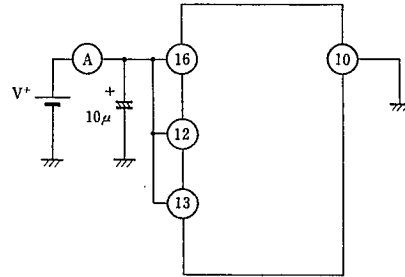

Test Circuit 13

Ich

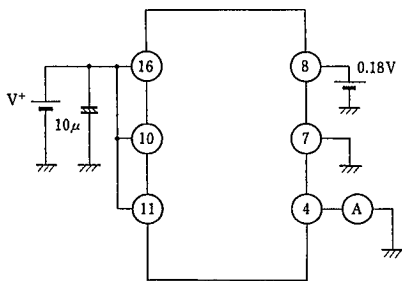

4

[查询"NJM2294V"供应商](#)

■ TERMINAL FUNCTION

PIN NO.	SYMBOL	FUNCTION	EQUIVALENT CIRCUIT
1	IF-IN	An IF amplifier input. Typical input impedance is 2k Ω .	
3	DEC	A Decoupling terminal which is connected with a decoupling capacitor.	
2	GND	Ground	
5	QUAD-IN	An input terminal of a quadrature detection circuit. This terminal will be connect with a ceramic discriminator.	
9	RSSI OUT	An RSSI Output. This voltage level is in logarithmic proportion to the input signal level.	
6	AF-OUT	An FM demodulated signal output.	

[查询"NJM2294V"供应商](#)

■ TERMINAL FUNCTION

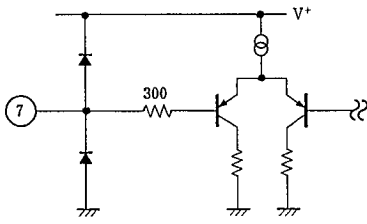
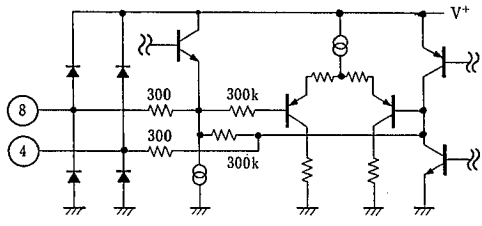
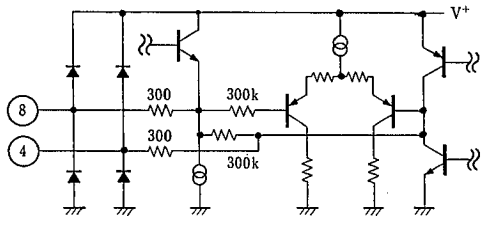
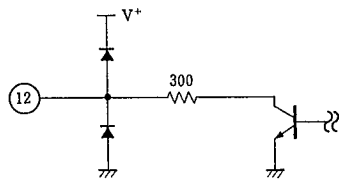
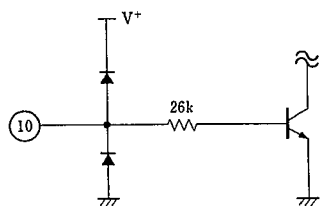
PIN NO.	SYMBOL	FUNCTION	EQUIVALENT CIRCUIT
7	LPF-IN	An input terminal of a low pass filter. This terminal is biased from the AF-OUT terminal (6pin) through an external RC filter.	
8	LPF-OUT	An output terminal of a low pass filter.	
4	FSK-REF	A Reference input terminal of a wave shaping comparator. This terminal is connected with an external capacitor.	
12	FSK-OUT	An output terminal of a wave shaping circuit. The Wave shaped signal inverted for the LPF output comes out.	
10	BS	A Control terminal of a battery saving circuit. H: This circuit is OFF. L: This circuit is ON.	

4

[查询"NJM2294V"供应商](#)

■ TERMINAL FUNCTION

PIN NO.	SYMBOL	FUNCTION	EQUIVALENT CIRCUIT
11	CHARGE	A Control terminal of a quick charge/discharge circuit. H: This circuit is ON. L: This circuit is OFF.	
13	VALM	An output terminal of the alarm signal. When V^+ drops down to 1.1V, this output becomes high.	
14	REG CONT	A Control terminal of an external PNP transistor used for the regulator.	
15	REG-OUT	A Monitoring terminal of the regulator.	
16	V^+	Supply voltage.	

[查询"NJM2294V"供应商](#)

■ FSK WAVE SHAPING FUNCTION

When the demodulated FSK signal is weak or noisy, the micro computer may fail to read data. The wave shaping circuit (comparator) will change those signals to the correct logical signal to prevent the readerror.

■ QUICK CHARGE/DISCHARGE FUNCTION

The DC voltage of the FSK-REF terminal is equal to that of the demodulated FSK signal. When the battery saving state turns into the ordinary state, the FSK-REF terminal voltage will be late to come up to the reference voltage by the time constant of an external capacitor and an internal resistor, and the wave shaped data may be failed. This circuit will charge/discharge the external capacitor quickly to prevent the error.

When the DC level of the FM demodulated output changes in the operation mode of this function, the FSK-REF terminal voltage follows to the FSK demodulated output DC voltage, and the FSK output duty ratio can be constant.

■ APPLICATION CIRCUIT

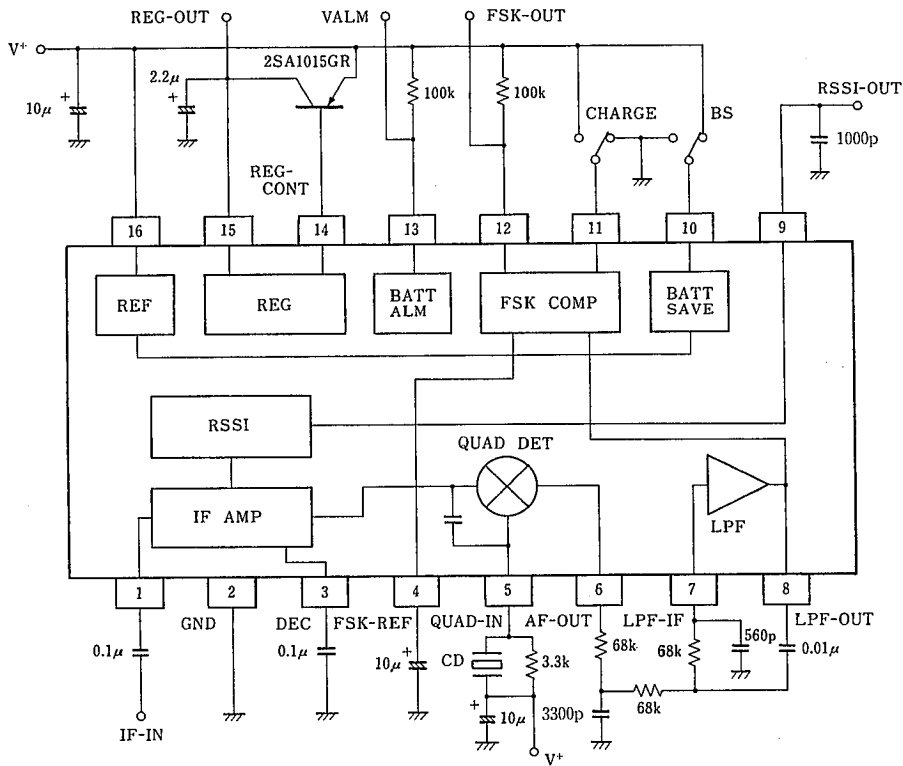

CD: CDBC455CX (MURATA MFG.)



NJM2294

[查询"NJM2294V"供应商](#)

MEMO

[CAUTION]

The specifications on this databook are only given for information , without any guarantee as regards either mistakes or omissions. The application circuits in this databook are described only to show representative usages of the product and not intended for the guarantee or permission of any right including the industrial rights.