

LMP2234 Quad

Micropower, Precision, RRO Amplifier with CMOS Input

General Description

The LMP2234 is a quad micropower precision amplifier designed for battery powered applications. The 1.8 to 5.5V operating voltage range and quiescent power consumption of only 62 μW extend the battery life in portable systems. The LMP2234 is part of the LMP[®] precision amplifier family. The high impedance CMOS input makes it ideal for instrumentation and other sensor interface applications.

The LMP2234 has a maximum offset voltage of 150 μV and 0.3 $\mu\text{V}/^\circ\text{C}$ offset drift along with low bias current of only ± 20 fA. These precise specifications make the LMP2234 a great choice for maintaining system accuracy and long term stability.

The LMP2234 has a rail-to-rail output that swings 15 mV from the supply voltage, which increases system dynamic range. The common mode input voltage range extends 200 mV below the negative supply, thus the LMP2234 is ideal for ground sensing in single supply applications.

The LMP2234 is offered in 14-Pin SOIC and TSSOP packages.

Features

(For $V_S = 5\text{V}$, Typical unless otherwise noted)

- Supply current (per channel) 9 μA
- Low TCV_{OS} $\pm 1.0 \mu\text{V}/^\circ\text{C}$ (max)
- V_{OS} $\pm 150 \mu\text{V}$ (max)
- Input bias current ± 20 fA
- PSRR 120 dB
- CMRR 97 dB
- Open loop gain 120 dB
- Gain bandwidth product 130 kHz
- Slew rate 58 V/ms
- Input voltage noise, $f = 1$ kHz 60 nV/ $\sqrt{\text{Hz}}$
- Temperature range -40°C to 125°C
- Rail-to-rail output

Applications

- Precision instrumentation amplifiers
- Battery powered medical instrumentation
- High impedance sensors
- Strain gauge bridge amplifier
- Thermocouple amplifiers

Typical Application

Strain Gauge Bridge Amplifier

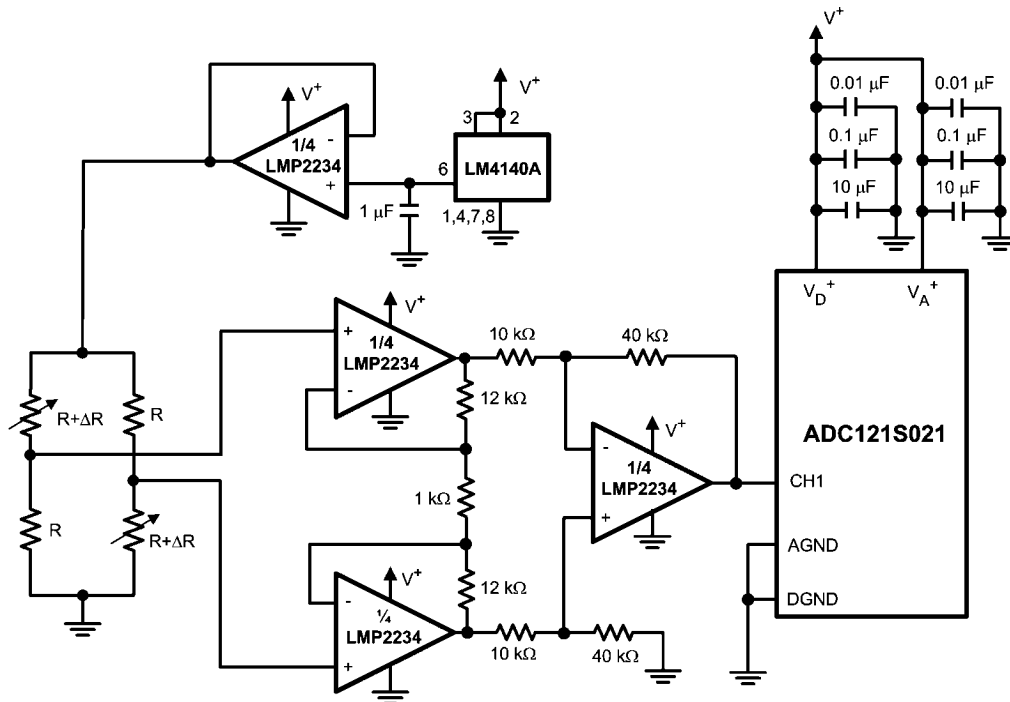

20203468

LMP[®] is a registered trademark of National Semiconductor Corporation.

Absolute Maximum Ratings (Note 1)

查询"LMP2234AMA"供应商

If Military/Aerospace specified devices are required, please contact the National Semiconductor Sales Office/Distributors for availability and specifications.

| | |
|--------------------------------------|--------------------------|
| ESD Tolerance(Note 2) | |
| Human Body Model | 2000V |
| Machine Model | 100V |
| Differential Input Voltage | ±300 mV |
| Supply Voltage ($V_S = V^+ - V^-$) | 6V |
| Voltage on Input/Output Pins | $V^+ + 0.3V, V^- - 0.3V$ |
| Storage Temperature Range | -65°C to 150°C |
| Junction Temperature(Note 3) | 150°C |

| | |
|----------------------------------|--------|
| Mounting Temperature | |
| Infrared or Convection (20 sec.) | +235°C |
| Wave Soldering Lead | |
| Temperature (10 sec.) | +260°C |

Operating Ratings (Note 1)

| | |
|---|----------------|
| Operating Temperature Range (Note 3) | -40°C to 125°C |
| Supply Voltage ($V_S = V^+ - V^-$) | 1.8V to 5.5V |
| Package Thermal Resistance (θ_{JA}) (Note 3) | |
| 14-Pin SOIC | 101.5 °C/W |
| 14-Pin TSSOP | 121 °C/W |

5V DC Electrical Characteristics (Note 4)

Unless otherwise specified, all limits are guaranteed for $T_A = 25^\circ\text{C}$, $V^+ = 5\text{V}$, $V^- = 0\text{V}$, $V_{CM} = V_O = V^+/2$, and $R_L > 1\text{M}\Omega$. **Boldface** limits apply at the temperature extremes.

| Symbol | Parameter | Conditions | Min (Note 6) | Typ (Note 5) | Max (Note 6) | Units |
|------------|------------------------------|--|---------------------|-----------------|---------------------|---------------------------|
| V_{OS} | Input Offset Voltage | | | ±10 | ±150 ±230 | µV |
| TCV_{OS} | Input Offset Voltage Drift | LMP2234A | | ±0.3 | ±1.0 | µV/°C |
| | | LMP2234B | | ±0.3 | ±2.5 | |
| I_{Bias} | Input Bias Current | | | ±0.02 | ±1 ±50 | pA |
| I_{OS} | Input Offset Current | | | ±5 | | fA |
| CMRR | Common Mode Rejection Ratio | $0\text{V} \leq V_{CM} \leq 4\text{V}$ | 81 80 | 97 | | dB |
| PSRR | Power Supply Rejection Ratio | $1.8\text{V} \leq V^+ \leq 5.5\text{V}$ $V_{CM} = 0\text{V}$ | 84 84 | 120 | | dB |
| CMVR | Common Mode Voltage Range | CMRR ≥ 80 dB CMRR ≥ 79 dB | -0.2 -0.2 | | 4.2 4.2 | V |
| A_{VOL} | Large Signal Voltage Gain | $V_O = 0.3\text{V}$ to 4.7V $R_L = 10\text{ k}\Omega$ to $V^+/2$ | 110 108 | 120 | | dB |
| V_O | Output Swing High | $R_L = 10\text{ k}\Omega$ to $V^+/2$ $V_{IN}(\text{diff}) = 100\text{ mV}$ | | 17 | 50 50 | mV from either rail |
| | Output Swing Low | $R_L = 10\text{ k}\Omega$ to $V^+/2$ $V_{IN}(\text{diff}) = -100\text{ mV}$ | | 17 | 50 50 | |
| I_O | Output Current (Note 7) | Sourcing, V_O to V^- $V_{IN}(\text{diff}) = 100\text{ mV}$ | 27 19 | 30 | | mA |
| | | Sinking, V_O to V^+ $V_{IN}(\text{diff}) = -100\text{ mV}$ | 17 12 | 22 | | |
| I_S | Supply Current | | | 36 | 48 50 | µA |

5V AC Electrical Characteristics (Note 4)

Unless otherwise specified, all limits are guaranteed for $T_A = 25^\circ\text{C}$, $V^+ = 5\text{V}$, $V^- = 0\text{V}$, $V_{CM} = V_O = V^+/2$, and $R_L > 1\text{M}\Omega$. **Boldface** limits apply at the temperature extremes.

| Symbol | Parameter | Conditions | Min (Note 6) | Typ (Note 5) | Max (Note 6) | Units |
|------------|------------------------|--|-----------------|-----------------|-----------------|-------|
| GBWP | Gain Bandwidth Product | $C_L = 20\text{ pF}$, $R_L = 10\text{ k}\Omega$ | | 130 | | kHz |
| SR | Slew Rate | $A_V = +1$ | Falling Edge | 33 | 58 | V/ms |
| | | | Rising Edge | 33 | 48 | |
| θ_m | Phase Margin | $C_L = 20\text{ pF}$, $R_L = 10\text{ k}\Omega$ | | 68 | | Deg |
| G_m | Gain Margin | $C_L = 20\text{ pF}$, $R_L = 10\text{ k}\Omega$ | | 27 | | dB |

| Symbol | Parameter | Conditions | Min (Note 6) | Typ (Note 5) | Max (Note 6) | Units |
|--------|--------------------------------------|--|-----------------|-----------------|-----------------|------------------------------|
| e_n | Input-Referred Voltage Noise Density | $f = 1 \text{ kHz}$ | | 60 | | $\text{nV}/\sqrt{\text{Hz}}$ |
| | Input-Referred Voltage Noise | 0.1 Hz to 10 Hz | | 2.3 | | μV_{PP} |
| i_n | Input-Referred Current Noise Density | $f = 1 \text{ kHz}$ | | 10 | | $\text{fA}/\sqrt{\text{Hz}}$ |
| THD+N | Total Harmonic Distortion + Noise | $f = 100 \text{ Hz}, R_L = 10 \text{ k}\Omega$ | | 0.002 | | % |

3.3V DC Electrical Characteristics (Note 4)

Unless otherwise specified, all limits are guaranteed for $T_A = 25^\circ\text{C}$, $V^+ = 3.3\text{V}$, $V^- = 0\text{V}$, $V_{\text{CM}} = V_O = V^+/2$, and $R_L > 1 \text{ M}\Omega$. **Boldface** limits apply at the temperature extremes.

| Symbol | Parameter | Conditions | Min (Note 6) | Typ (Note 5) | Max (Note 6) | Units |
|--------------------------|------------------------------|---|---------------------|-----------------|--|---------------------------------|
| V_{OS} | Input Offset Voltage | | | ± 10 | ± 160 ± 250 | μV |
| TCV_{OS} | Input Offset Voltage Drift | LMP2234A | | ± 0.3 | ± 1.0 | $\mu\text{V}/^\circ\text{C}$ |
| | | LMP2234B | | ± 0.3 | ± 2.5 | |
| I_{Bias} | Input Bias Current | | | ± 0.02 | ± 1 ± 50 | pA |
| I_{OS} | Input Offset Current | | | ± 5 | | fA |
| CMRR | Common Mode Rejection Ratio | $0\text{V} \leq V_{\text{CM}} \leq 2\text{V}$ | 79 77 | 92 | | dB |
| PSRR | Power Supply Rejection Ratio | $1.8\text{V} \leq V^+ \leq 5.5\text{V}$ $V_{\text{CM}} = 0\text{V}$ | 84 84 | 120 | | dB |
| CMVR | Common Mode Voltage Range | CMRR $\geq 78 \text{ dB}$ CMRR $\geq 77 \text{ dB}$ | -0.2 -0.2 | | 2.5 2.5 | V |
| A_{VOL} | Large Signal Voltage Gain | $V_O = 0.3\text{V}$ to 3V $R_L = 10 \text{ k}\Omega$ to $V^+/2$ | 108 107 | 120 | | dB |
| V_O | Output Swing High | $R_L = 10 \text{ k}\Omega$ to $V^+/2$ $V_{\text{IN}}(\text{diff}) = 100 \text{ mV}$ | | 14 | 50 50 | mV from either rail |
| | Output Swing Low | $R_L = 10 \text{ k}\Omega$ to $V^+/2$ $V_{\text{IN}}(\text{diff}) = -100 \text{ mV}$ | | 14 | 50 50 | |
| I_O | Output Current (Note 7) | Sourcing, V_O to V^- $V_{\text{IN}}(\text{diff}) = 100 \text{ mV}$ | 11 8 | 14 | | mA |
| | | Sinking, V_O to V^+ $V_{\text{IN}}(\text{diff}) = -100 \text{ mV}$ | 8 5 | 11 | | |
| I_S | Supply Current | | | 34 | 44 46 | μA |

3.3V AC Electrical Characteristics (Note 4)

Unless otherwise is specified, all limits are guaranteed for $T_A = 25^\circ\text{C}$, $V^+ = 3.3\text{V}$, $V^- = 0\text{V}$, $V_{\text{CM}} = V_O = V^+/2$, and $R_L > 1 \text{ M}\Omega$. **Boldface** limits apply at the temperature extremes.

| Symbol | Parameter | Conditions | Min (Note 6) | Typ (Note 5) | Max (Note 6) | Units |
|------------|--------------------------------------|---|-----------------|-----------------|-----------------|------------------------------|
| GBWP | Gain Bandwidth Product | $C_L = 20 \text{ pF}, R_L = 10 \text{ k}\Omega$ | | 128 | | kHz |
| SR | Slew Rate | $A_V = +1, C_L = 20 \text{ pF}$ $R_L = 10 \text{ k}\Omega$ | Falling Edge | | 58 | V/ms |
| | | | Rising Edge | | 48 | |
| θ_m | Phase Margin | $C_L = 20 \text{ pF}, R_L = 10 \text{ k}\Omega$ | | 66 | | Deg |
| G_m | Gain Margin | $C_L = 20 \text{ pF}, R_L = 10 \text{ k}\Omega$ | | 26 | | dB |
| e_n | Input-Referred Voltage Noise Density | $f = 1 \text{ kHz}$ | | 60 | | $\text{nV}/\sqrt{\text{Hz}}$ |
| | Input-Referred Voltage Noise | 0.1 Hz to 10 Hz | | 2.4 | | μV_{PP} |
| i_n | Input-Referred Current Noise Density | $f = 1 \text{ kHz}$ | | 10 | | $\text{fA}/\sqrt{\text{Hz}}$ |
| THD+N | Total Harmonic Distortion + Noise | $f = 100 \text{ Hz}, R_L = 10 \text{ k}\Omega$ | | 0.003 | | % |

2.5V DC Electrical Characteristics (Note 4)

Unless otherwise specified, all limits are guaranteed for $T_A = 25^\circ\text{C}$, $V^+ = 2.5\text{V}$, $V^- = 0\text{V}$, $V_{\text{CM}} = V_O = V^+/2$, and $R_L > 1\text{M}\Omega$. **Boldface** limits apply at the temperature extremes.

| Symbol | Parameter | Conditions | Min (Note 6) | Typ (Note 5) | Max (Note 6) | Units |
|--------------------------|------------------------------|---|-------------------|-----------------|--|---------------------------------|
| V_{OS} | Input Offset Voltage | | | ± 10 | ± 190 ± 275 | μV |
| TCV_{OS} | Input Offset Voltage Drift | LMP2234A | | ± 0.3 | ± 1.0 | $\mu\text{V}/^\circ\text{C}$ |
| | | LMP2234B | | ± 0.3 | ± 2.5 | |
| I_{BIAS} | Input Bias Current | | | ± 0.02 | ± 1.0 ± 50 | pA |
| I_{OS} | Input Offset Current | | | ± 5 | | fA |
| CMRR | Common Mode Rejection Ratio | $0\text{V} \leq V_{\text{CM}} \leq 1.5\text{V}$ | 77 76 | 91 | | dB |
| PSRR | Power Supply Rejection Ratio | $1.8\text{V} \leq V^+ \leq 5.5\text{V}$ $V_{\text{CM}} = 0\text{V}$ | 84 84 | 120 | | dB |
| CMVR | Common Mode Voltage Range | CMRR $\geq 77\text{ dB}$ | -0.2 | | 1.7 | V |
| | | CMRR $\geq 76\text{ dB}$ | -0.2 | | 1.7 | |
| A_{VOL} | Large Signal Voltage Gain | $V_O = 0.3\text{V}$ to 2.2V $R_L = 10\text{ k}\Omega$ to $V^+/2$ | 104 104 | 120 | | dB |
| V_O | Output Swing High | $R_L = 10\text{ k}\Omega$ to $V^+/2$ $V_{\text{IN}}(\text{diff}) = 100\text{ mV}$ | | 12 | 50 50 | mV from either rail |
| | Output Swing Low | $R_L = 10\text{ k}\Omega$ to $V^+/2$ $V_{\text{IN}}(\text{diff}) = -100\text{ mV}$ | | 13 | 50 50 | |
| I_O | Output Current (Note 7) | Sourcing, V_O to V^- $V_{\text{IN}}(\text{diff}) = 100\text{ mV}$ | 5 4 | 8 | | mA |
| | | Sinking, V_O to V^+ $V_{\text{IN}}(\text{diff}) = -100\text{ mV}$ | 3.5 2.5 | 7 | | |
| I_S | Supply Current | | | 32 | 44 46 | μA |

2.5V AC Electrical Characteristics (Note 4)

Unless otherwise specified, all limits are guaranteed for $T_A = 25^\circ\text{C}$, $V^+ = 2.5\text{V}$, $V^- = 0\text{V}$, $V_{\text{CM}} = V_O = V^+/2$, and $R_L > 1\text{M}\Omega$. **Boldface** limits apply at the temperature extremes.

| Symbol | Parameter | Conditions | Min (Note 6) | Typ (Note 5) | Max (Note 6) | Units |
|------------|--------------------------------------|--|-----------------|-----------------|-----------------|------------------------------|
| GBWP | Gain Bandwidth Product | $C_L = 20\text{ pF}$, $R_L = 10\text{ k}\Omega$ | | 128 | | kHz |
| SR | Slew Rate | $A_V = +1$, $C_L = 20\text{ pF}$ $R_L = 10\text{ k}\Omega$ | Falling Edge | | 58 | V/ms |
| | | | Rising Edge | | 48 | |
| θ_m | Phase Margin | $C_L = 20\text{ pF}$, $R_L = 10\text{ k}\Omega$ | | 64 | | Deg |
| G_m | Gain Margin | $C_L = 20\text{ pF}$, $R_L = 10\text{ k}\Omega$ | | 26 | | dB |
| e_n | Input-Referred Voltage Noise Density | $f = 1\text{ kHz}$ | | 60 | | $\text{nV}/\sqrt{\text{Hz}}$ |
| | Input-Referred Voltage Noise | 0.1 Hz to 10 Hz | | 2.5 | | μV_{PP} |
| i_n | Input-Referred Current Noise Density | $f = 1\text{ kHz}$ | | 10 | | $\text{fA}/\sqrt{\text{Hz}}$ |
| THD+N | Total Harmonic Distortion + Noise | $f = 100\text{ Hz}$, $R_L = 10\text{ k}\Omega$ | | 0.005 | | $\%$ |

2.0V DC Electrical Characteristics(Note 4) Unless otherwise specified, all limits are guaranteed for $T_A = 25^\circ\text{C}$, $V_+ = 2.0\text{V}$, $V_- = 0\text{V}$, $V_{\text{CM}} = V_O = V^+/2$, and $R_L > 1\text{M}\Omega$. **Boldface** limits apply at the temperature extremes.

| Symbol | Parameter | Conditions | Min (Note 6) | Typ (Note 5) | Max (Note 6) | Units |
|--------------------------|------------------------------|---|-----------------|-----------------|--|------------------------------|
| V_{OS} | Input Offset Voltage | | | ± 10 | ± 210 ± 300 | μV |
| TCV_{OS} | Input Offset Voltage Drift | LMP2234A | | ± 0.3 | ± 1.0 | $\mu\text{V}/^\circ\text{C}$ |
| | | LMP2234B | | ± 0.3 | ± 2.5 | |
| I_{BIAS} | Input Bias Current | | | ± 0.02 | | pA |
| I_{OS} | Input Offset Current | | | ± 5 | | fA |
| CMRR | Common Mode Rejection Ratio | $0\text{V} \leq V_{\text{CM}} \leq 0.7\text{V}$ | | 92 | | dB |
| PSRR | Power Supply Rejection Ratio | $1.8\text{V} \leq V^+ \leq 5.5\text{V}$ $V_{\text{CM}} = 0\text{V}$ | 84 84 | 120 | | dB |
| CMVR | Common Mode Voltage Range | CMRR $\geq 77\text{ dB}$ | | -0.2 to 1.2 | | V |
| A_{VOL} | Large Signal Voltage Gain | $V_O = 0.3\text{V}$ to 1.7V $R_L = 10\text{ k}\Omega$ to $V^+/2$ | | 120 | | dB |
| V_O | Output Swing High | $R_L = 10\text{ k}\Omega$ to $V^+/2$ $V_{\text{IN}}(\text{diff}) = 100\text{ mV}$ | | 12 | | mV from either rail |
| | Output Swing Low | $R_L = 10\text{ k}\Omega$ to $V^+/2$ $V_{\text{IN}}(\text{diff}) = -100\text{ mV}$ | | 13 | | |
| I_O | Output Current (Note 7) | Sourcing, V_O to V^- $V_{\text{IN}}(\text{diff}) = 100\text{ mV}$ | | 5 | | mA |
| | | Sinking, V_O to V^+ $V_{\text{IN}}(\text{diff}) = -100\text{ mV}$ | | 5 | | |
| I_S | Supply Current | | | 31 | 44 46 | μA |

2.0V AC Electrical Characteristics(Note 4) Unless otherwise is specified, all limits are guaranteed for $T_A = 25^\circ\text{C}$, $V^+ = 2.0\text{V}$, $V^- = 0\text{V}$, $V_{\text{CM}} = V_O = V^+/2$, and $R_L > 1\text{M}\Omega$. **Boldface** limits apply at the temperature extremes.

| Symbol | Parameter | Conditions | Min (Note 6) | Typ (Note 5) | Max (Note 6) | Units |
|------------|--------------------------------------|--|-----------------|-----------------|-----------------|------------------------------|
| GBWP | Gain Bandwidth Product | $C_L = 20\text{ pF}$, $R_L = 10\text{ k}\Omega$ | | 127 | | kHz |
| SR | Slew Rate | $A_V = +1$, $C_L = 20\text{ pF}$ $R_L = 10\text{ k}\Omega$ | Falling Edge | | 58 | V/ms |
| | | | Rising Edge | | 48 | |
| θ_m | Phase Margin | $C_L = 20\text{ pF}$, $R_L = 10\text{ k}\Omega$ | | 70 | | Deg |
| G_m | Gain Margin | $C_L = 20\text{ pF}$, $R_L = 10\text{ k}\Omega$ | | 25 | | dB |
| e_n | Input-Referred Voltage Noise Density | $f = 1\text{ kHz}$ | | 60 | | $\text{nV}/\sqrt{\text{Hz}}$ |
| | Input-Referred Voltage Noise | 0.1 Hz to 10 Hz | | 2.4 | | μV_{PP} |
| i_n | Input-Referred Current Noise Density | $f = 1\text{ kHz}$ | | 10 | | $\text{fA}/\sqrt{\text{Hz}}$ |
| THD+N | Total Harmonic Distortion + Noise | $f = 100\text{ Hz}$, $R_L = 10\text{ k}\Omega$ | | 0.005 | | % |

查询 LMP2234AMA 供应商

Note 1: Absolute Maximum Ratings indicate limits beyond which damage may occur. Operating Ratings indicate conditions for which the device is intended to be functional, but specific performance is not guaranteed. For guaranteed specifications and test conditions, see the Electrical Characteristics.

Note 2: Human Body Model, applicable std. MIL-STD-883, Method 3015.7. Machine Model, applicable std. JESD22-A115-A (ESD MM std. of JEDEC) Field-Induced Charge-Device Model, applicable std. JESD22-C101-C (ESD FICDM std. of JEDEC).

Note 3: The maximum power dissipation is a function of $T_{J(MAX)}$, θ_{JA} . The maximum allowable power dissipation at any ambient temperature is $P_D = (T_{J(MAX)} - T_A) / \theta_{JA}$. All numbers apply for packages soldered directly onto a PC Board.

Note 4: Electrical Table values apply only for factory testing conditions at the temperature indicated. Factory testing conditions result in very limited self-heating of the device such that $T_J = T_A$. No guarantee of parametric performance is indicated in the electrical tables under conditions of internal self-heating where $T_J > T_A$. Absolute Maximum Ratings indicate junction temperature limits beyond which the device may be permanently degraded, either mechanically or electrically.

Note 5: Typical values represent the most likely parametric norm as determined at the time of characterization. Actual typical values may vary over time and will also depend on the application and configuration. The typical values are not tested and are not guaranteed on shipped production material.

Note 6: All limits are guaranteed by testing, statistical analysis or design.

Note 7: The short circuit test is a momentary open loop test.

Ordering Information

| Package | Part Number | Temperature Range | Package Marking | Transport Media | NSC Drawing | |
|--------------|-------------|-------------------|--------------------------|--------------------------|--------------------------|-------|
| 14-Pin SOIC | LMP2234AMA | -40°C to 125°C | LMP2234AMA | 55 Units/Rail | M14A | |
| | LMP2234AMAE | | | 250 Units Tape and Reel | | |
| | LMP2234AMAX | | | 2.5k Units Tape and Reel | | |
| | LMP2234BMA | | 55 Units/Rail | | | |
| | LMP2234BMAE | | 250 Units Tape and Reel | | | |
| | LMP2234BMAX | | 2.5k Units Tape and Reel | | | |
| 14-Pin TSSOP | LMP2234AMT | | -40°C to 125°C | LMP2234AMT | 94 Units/Rail | MTC14 |
| | LMP2234AMTE | | | | 250 Units Tape and Reel | |
| | LMP2234AMTX | | | | 2.5k Units Tape and Reel | |
| | LMP2234BMT | | | 94 Units/Rail | | |
| | LMP2234BMTE | | | 250 Units Tape and Reel | | |
| | LMP2234BMTX | | | 2.5k Units Tape and Reel | | |

Connection Diagram

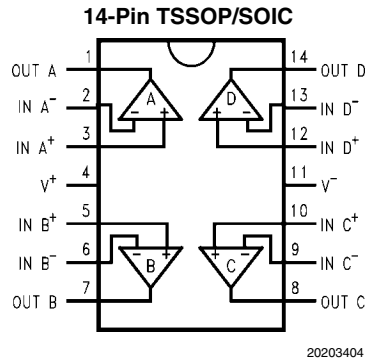

Typical Performance Characteristics

Unless otherwise Specified: $T_A = 25^\circ\text{C}$, $V_S = 5\text{V}$, $V_{CM} = V_S/2$, where

$V_S = V_{DD}$ 查询"LMP2234AMA"供应商

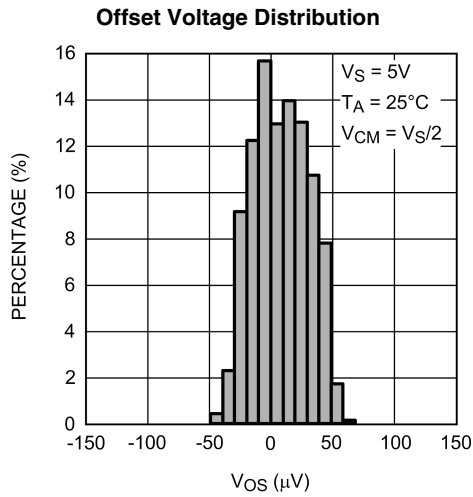

20203407

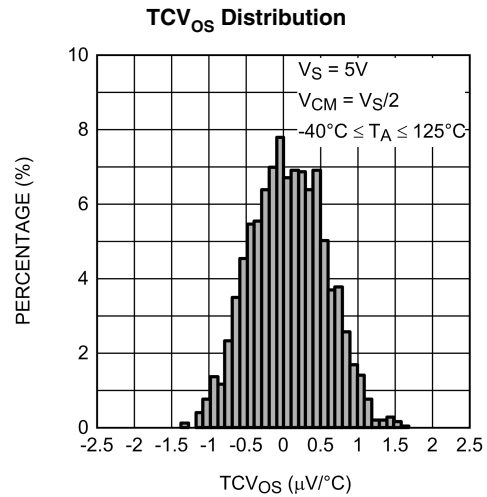

20203411

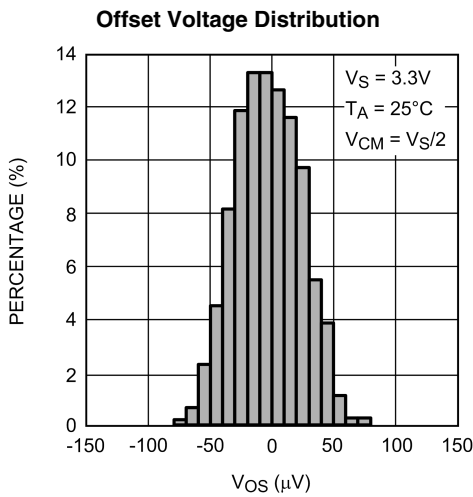

20203406

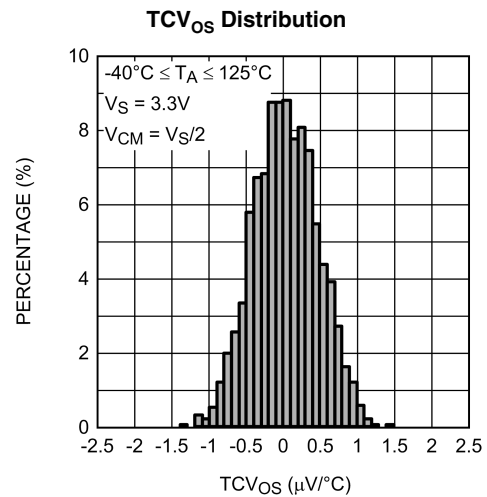

20203410

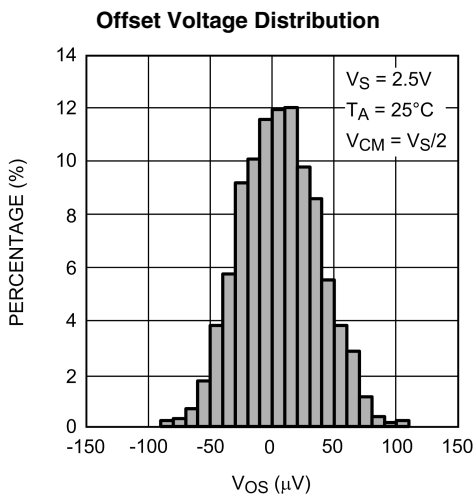

20203405

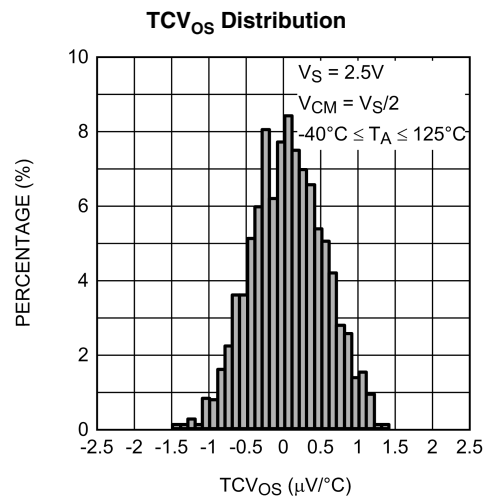

20203409

查询"LMP2234AMA"供应商

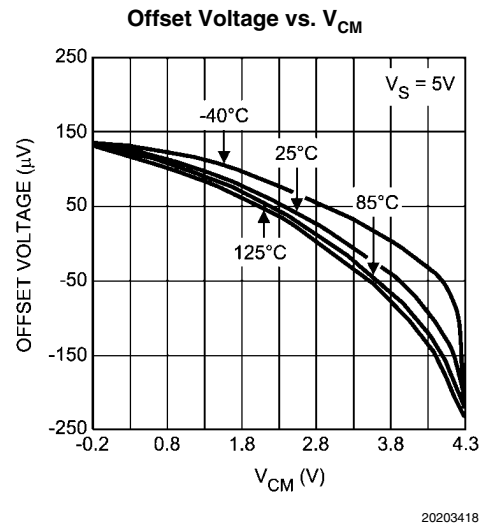
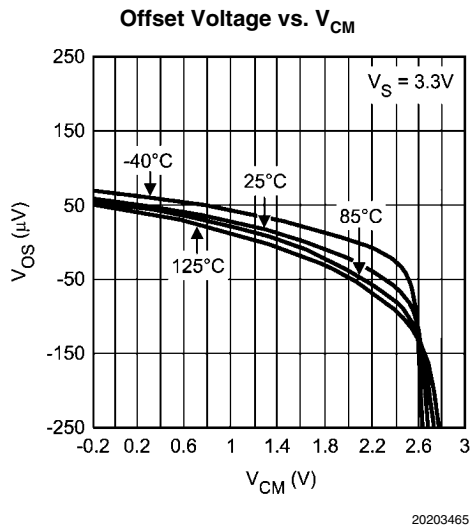
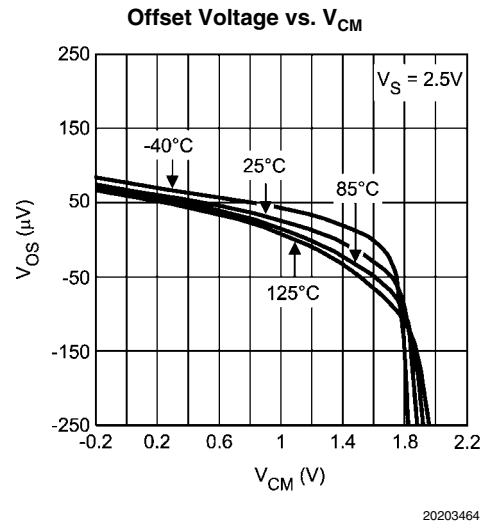
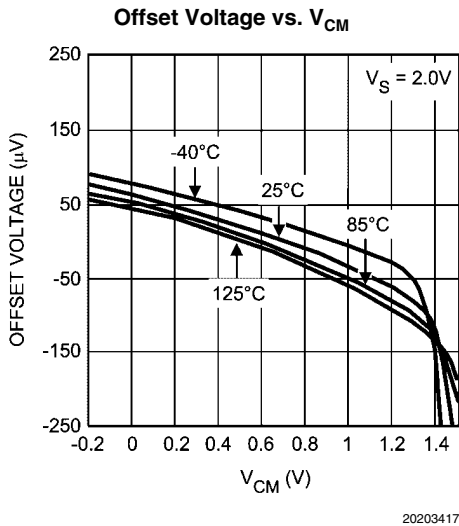
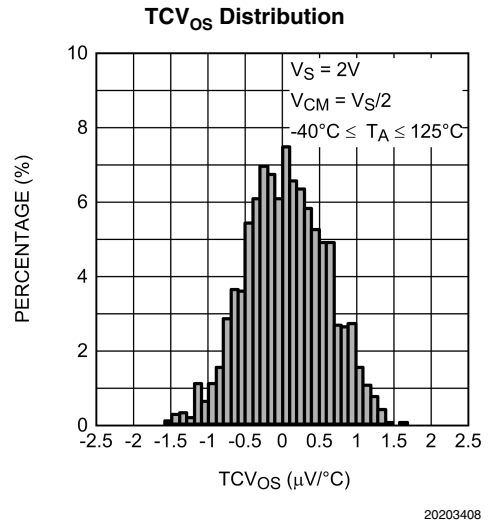
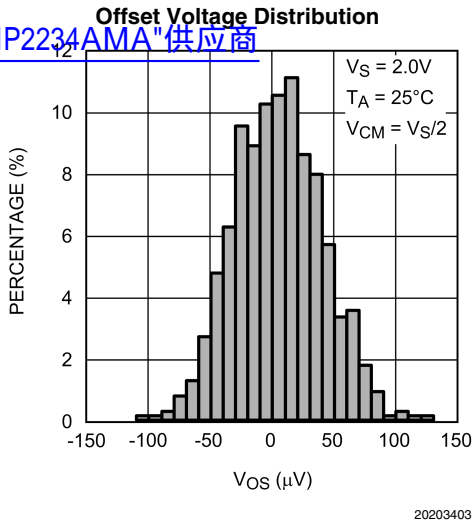

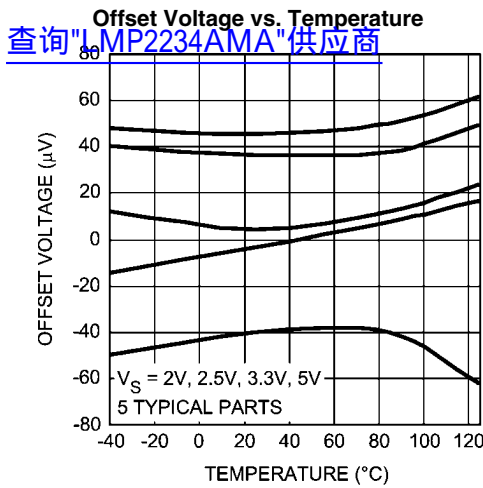

20203420

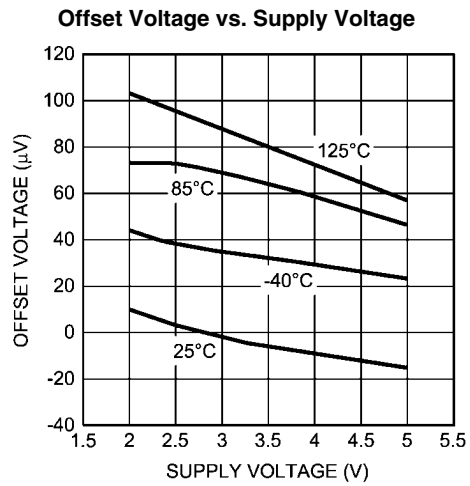

20203427

0.1 Hz to 10 Hz Voltage Noise

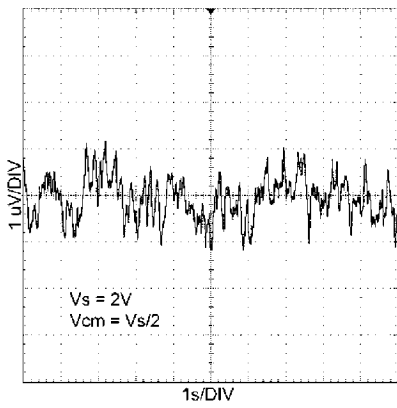

20203433

0.1 Hz to 10 Hz Voltage Noise

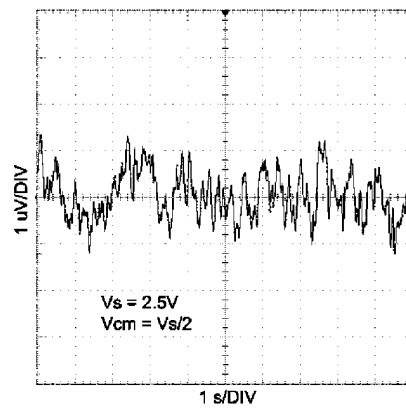

20203434

0.1 Hz to 10 Hz Voltage Noise

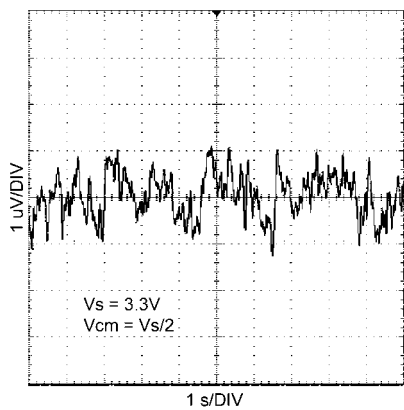

20203432

0.1 Hz to 10 Hz Voltage Noise

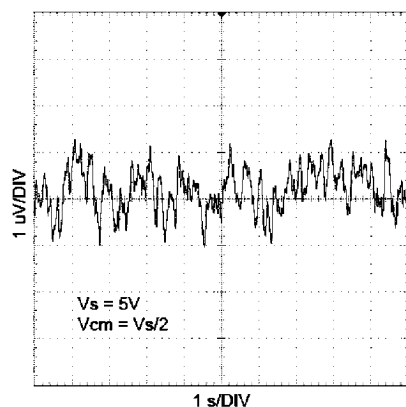

20203431

查询"LMP2234AAMA"供应商

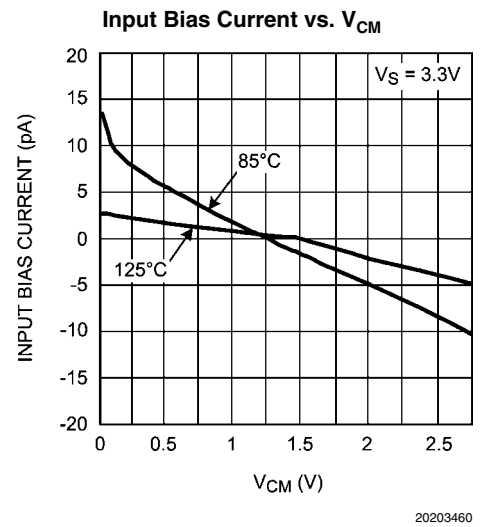
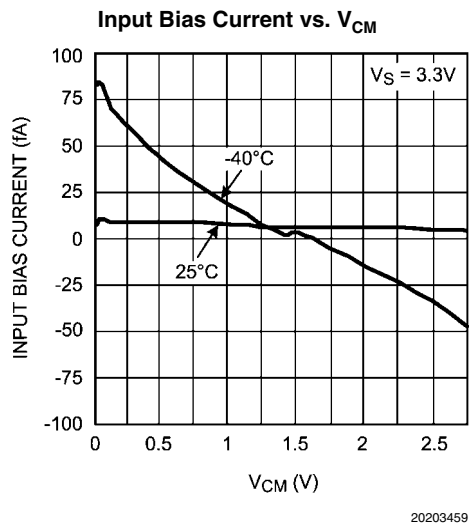
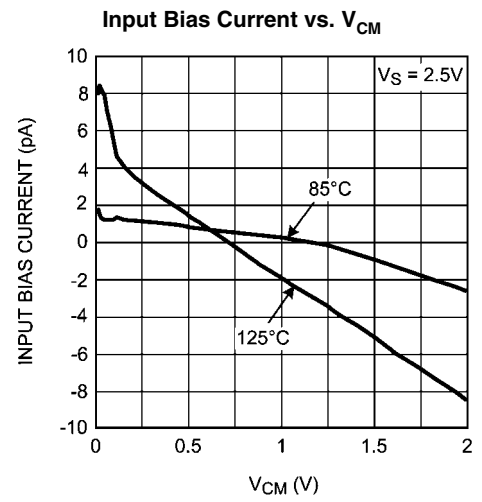
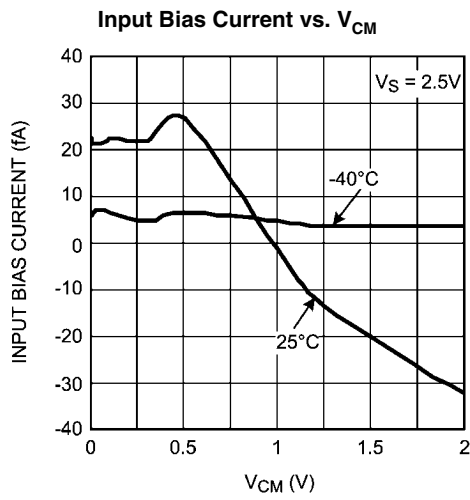
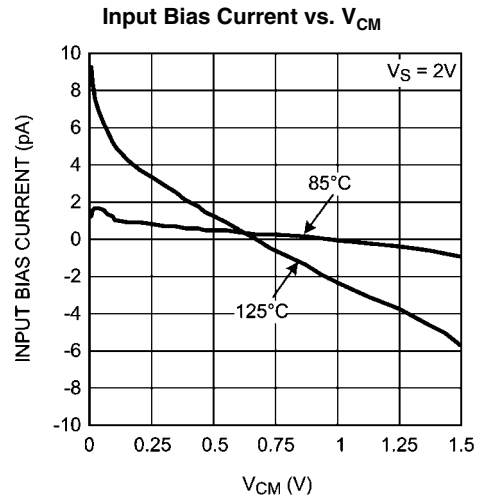
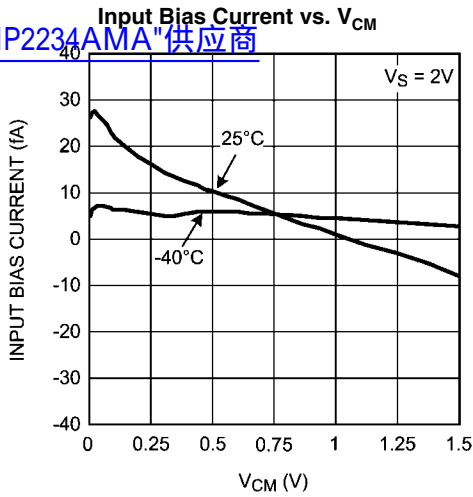

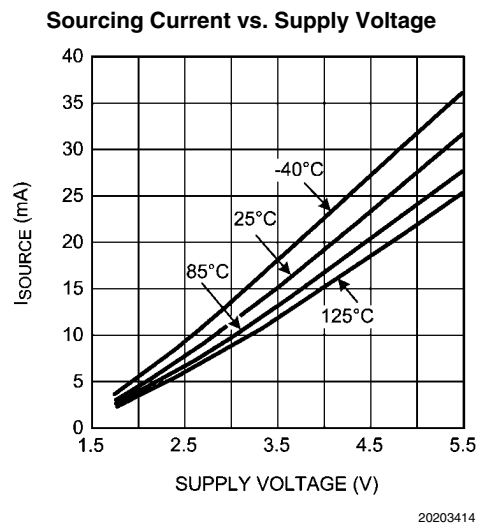
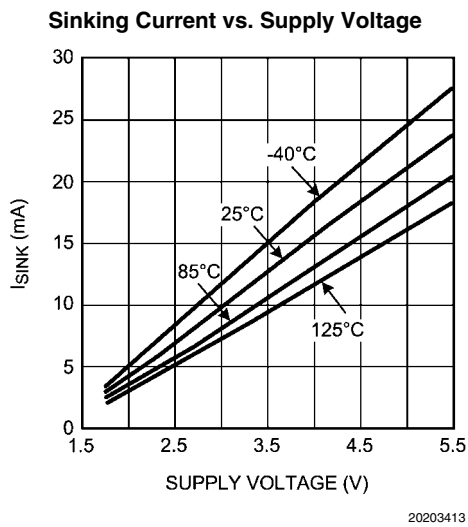
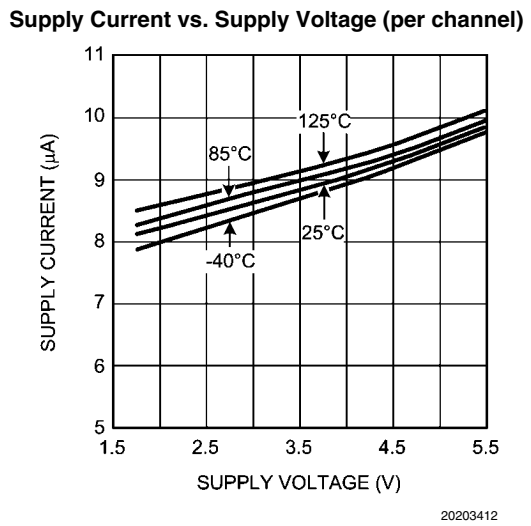
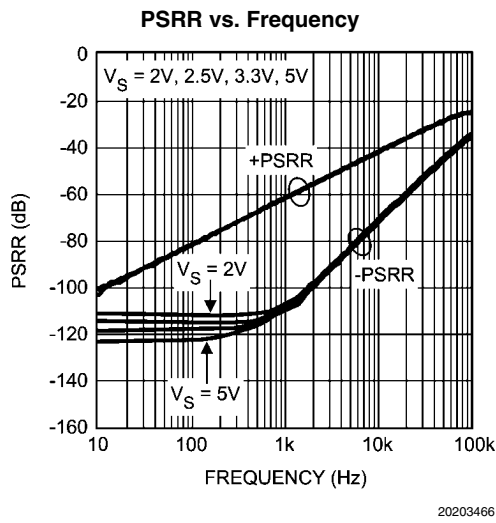
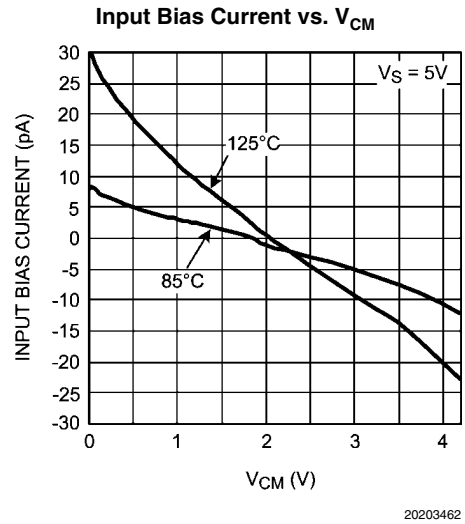
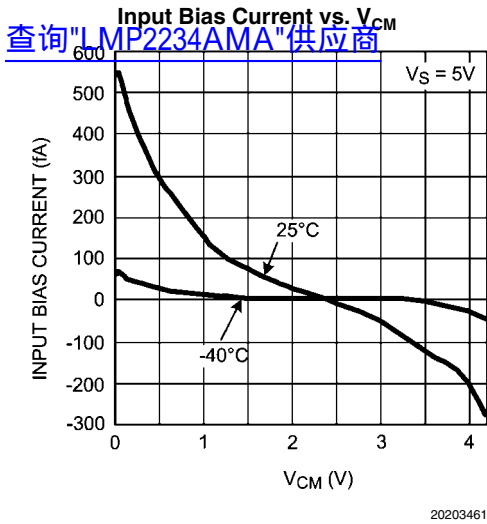

Output Swing High vs. Supply Voltage

查询"LMP2234"供应商

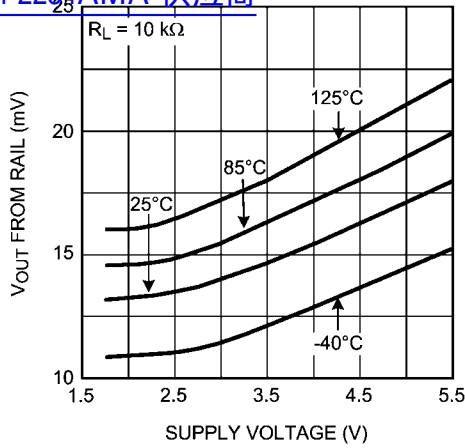

20203415

Output Swing Low vs. Supply Voltage

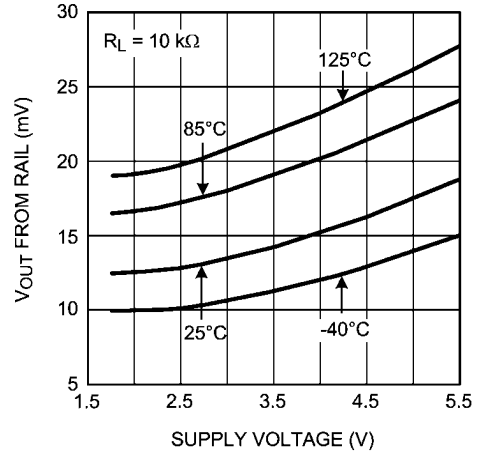

20203416

Open Loop Frequency Response

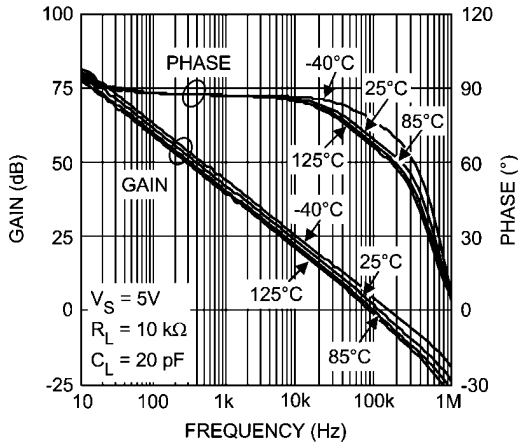

20203421

Open Loop Frequency Response

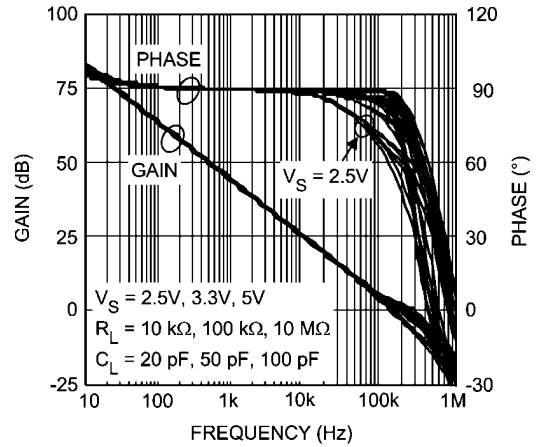

20203422

Phase Margin vs. Capacitive Load

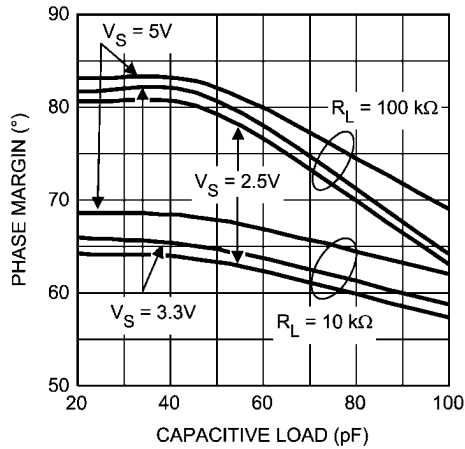

20203463

Slew Rate vs. Supply Voltage

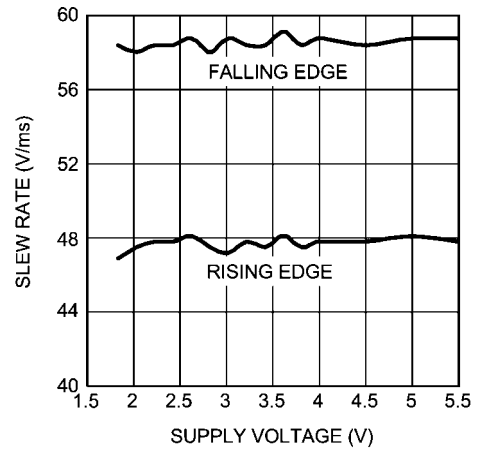

20203430

THD+N vs. Amplitude
[查询"LMP2234AMA"供应商](#)

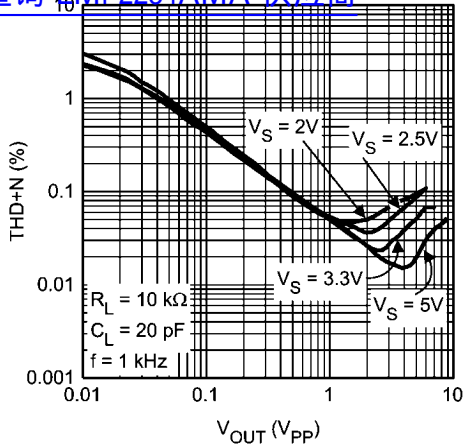

20203428

THD+N vs. Frequency

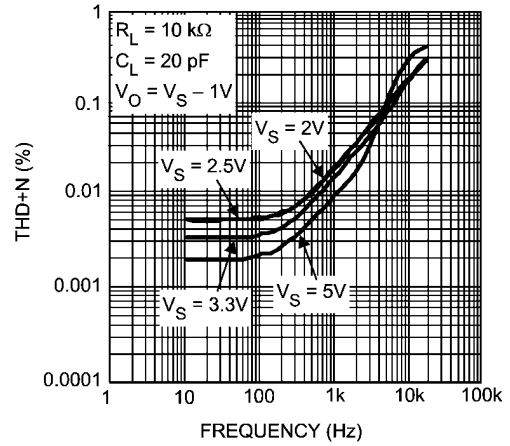

20203429

Large Signal Step Response

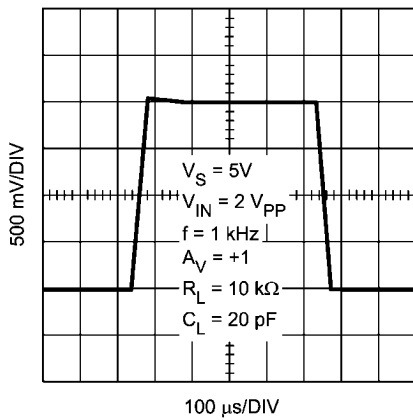

20203424

Small Signal Step Response

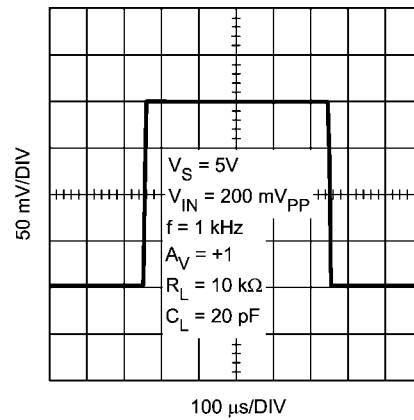

20203423

Large Signal Step Response

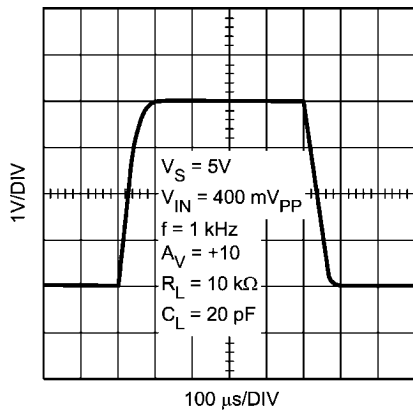

20203426

Small Signal Step Response

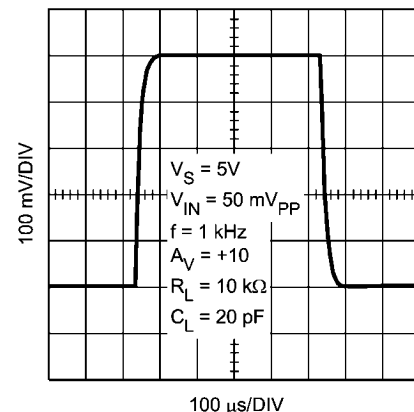

20203425

查询"LMP2234AMA"供应商

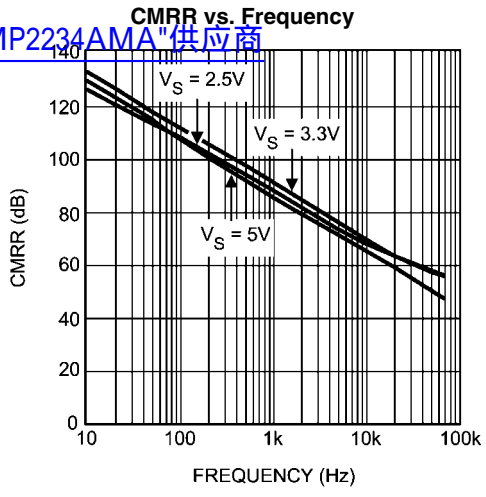

20203467

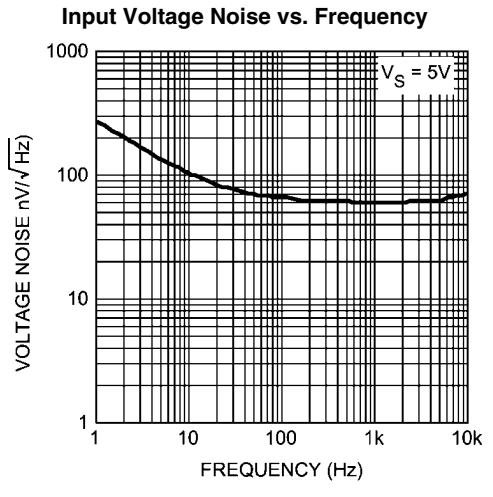

20203419

Application Information

LMP2234 查询"LMP2234AMA"供应商

The LMP2234 is a quad CMOS precision amplifier that offers low offset voltage, low offset voltage drift, and high gain while consuming less than 10 μA of supply current per channel.

The LMP2234 is a micropower op amp, consuming only 36 μA of current. Micropower op amps extend the run time of battery powered systems and reduce energy consumption in energy limited systems. The operating voltage range of 1.8V to 5.5V along with the ultra-low supply current extend the battery run time in two ways. The extended power supply voltage range of 1.8V to 5.5V enables the op amp to function when the battery voltage has depleted from its nominal value down to 1.8V. In addition, the lower power consumption increases the life of the battery.

The LMP2234 has input referred offset voltage of only ± 150 μV maximum at room temperature. This offset is guaranteed to be less than ± 230 μV over temperature. This minimal offset voltage along with very low TCV_{OS} of only 0.3 $\mu\text{V}/^\circ\text{C}$ typical allows more accurate signal detection and amplification in precision applications.

The low input bias current of only ± 20 fA gives the LMP2234 superiority for use in high impedance sensor applications. Bias current of an amplifier flows through source resistance of the sensor and the voltage resulting from this current flow appears as a noise voltage on the input of the amplifier. The low input bias current enables the LMP2234 to interface with high impedance sensors while generating negligible voltage noise. Thus the LMP2234 provides better signal fidelity and a higher signal-to-noise ratio when interfacing with high impedance sensors.

National Semiconductor is heavily committed to precision amplifiers and the market segments they serve. Technical support and extensive characterization data is available for sensitive applications or applications with a constrained error budget.

The operating voltage range of 1.8V to 5.5V over the extensive temperature range of -40°C to 125°C makes the LMP2234 an excellent choice for low voltage precision applications with extensive temperature requirements.

The LMP2234 is offered in the 14-pin TSSOP and 14-pin SOIC package. These small packages are ideal solutions for area constrained PC boards and portable electronics.

TOTAL NOISE CONTRIBUTION

The LMP2234 has very low input bias current, very low input current noise, and low input voltage noise for micropower amplifiers. As a result, this amplifier makes a great choice for circuits with high impedance sensor applications.

shows the typical input noise of the LMP2234 as a function of source resistance at $f = 1$ kHz where:

- e_n denotes the input referred voltage noise
- e_i is the voltage drop across source resistance due to input referred current noise or $e_i = R_S \cdot i_n$
- e_t shows the thermal noise of the source resistance
- e_{ni} shows the total noise on the input.

Where:

$$e_{ni} = \sqrt{e_n^2 + e_i^2 + e_t^2}$$

The input current noise of the LMP2234 is so low that it will not become the dominant factor in the total noise unless source resistance exceeds 300 $\text{M}\Omega$, which is an unrealistically high value. As is evident in *Figure 1*, at lower R_S values, total noise is dominated by the amplifier's input voltage noise. Once R_S is larger than 100 $\text{k}\Omega$, then the dominant noise factor becomes the thermal noise of R_S . As mentioned before, the current noise will not be the dominant noise factor for any practical application.

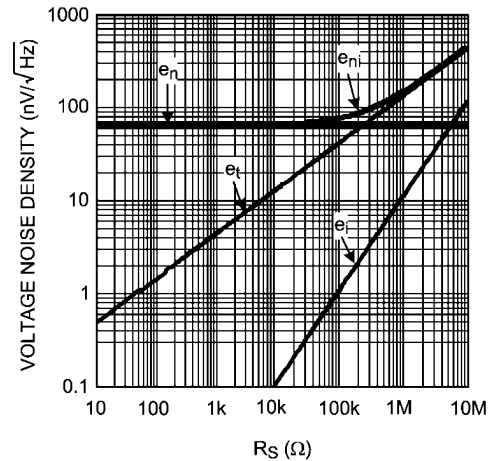

20203448

FIGURE 1. Total Input Noise

VOLTAGE NOISE REDUCTION

The LMP2234 has an input voltage noise of $60 \text{ nV}/\sqrt{\text{Hz}}$. While this value is very low for micropower amplifiers, this input voltage noise can be further reduced by placing multiple amplifiers in parallel as shown in *Figure 2*. The total voltage noise on the output of this circuit is divided by the square root of the number of amplifiers used in this parallel combination. This is because each individual amplifier acts as an independent noise source, and the average noise of independent sources is the quadrature sum of the independent sources divided by the number of sources. For N identical amplifiers, this means:

$$\begin{aligned} \text{REDUCED INPUT VOLTAGE NOISE} &= \frac{1}{N} \sqrt{e_{n1}^2 + e_{n2}^2 + \dots + e_{nN}^2} \\ &= \frac{1}{N} \sqrt{N e_n^2} = \frac{\sqrt{N}}{N} e_n \\ &= \frac{1}{\sqrt{N}} e_n \end{aligned}$$

Figure 2 shows a schematic of this input voltage noise reduction circuit using the LMP2234. Typical resistor values are: $R_G = 10\Omega$, $R_F = 1\text{ k}\Omega$, and $R_O = 1\text{ k}\Omega$.

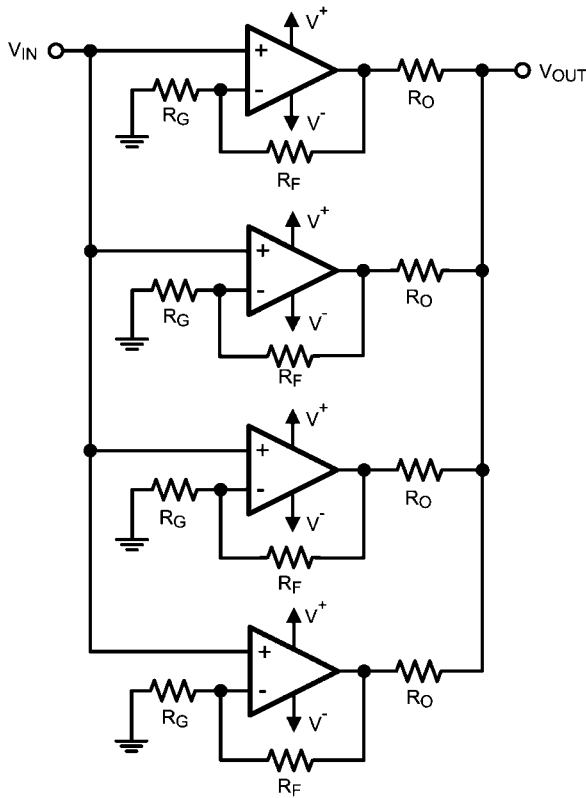

FIGURE 2. Noise Reduction Circuit

PRECISION INSTRUMENTATION AMPLIFIER

Measurement of very small signals with an amplifier requires close attention to the input impedance of the amplifier, the gain of the signal on the inputs, and the gain on each input of the amplifier. This is because the difference of the input signal on the two inputs is of interest and the common signal is considered noise. A classic circuit implementation that is used is an instrumentation amplifier. Instrumentation amplifiers have a finite, accurate, and stable gain. They also have extremely high input impedances and very low output impedances. Finally they have an extremely high CMRR so that the amplifier can only respond to the differential signal. A typical instrumentation amplifier is shown in Figure 3.

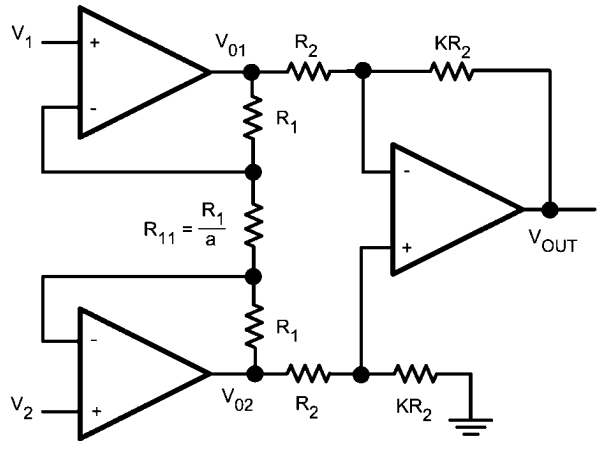

FIGURE 3. Instrumentation Amplifier

There are two stages in this amplifier. The last stage, the output stage, is a differential amplifier. In an ideal case the two amplifiers of the first stage, the input stage, would be configured as buffers to isolate the inputs. However they cannot be connected as followers because of mismatch in amplifiers. That is why there is a balancing resistor between the two. The product of the two stages of gain will give the gain of the instrumentation amplifier. Ideally, the CMRR should be infinite. However the output stage has a small non-zero common mode gain which results from resistor mismatch.

In the input stage of the circuit, current is the same across all resistors. This is due to the high input impedance and low input bias current of the LMP2234.

$$\text{GIVEN: } I_{R_1} = I_{R_{11}} \tag{1}$$

By Ohm's Law:

$$\begin{aligned} V_{O1} - V_{O2} &= (2R_1 + R_{11}) I_{R_{11}} \\ &= (2a + 1) R_{11} \cdot I_{R_{11}} \\ &= (2a + 1) V_{R_{11}} \end{aligned} \tag{2}$$

However:

$$V_{R_{11}} = V_1 - V_2 \tag{3}$$

So we have:

$$V_{O1} - V_{O2} = (2a+1)(V_1 - V_2) \tag{4}$$

Now looking at the output of the instrumentation amplifier:

$$\begin{aligned} V_O &= \frac{KR_2}{R_2} (V_{O2} - V_{O1}) \\ &= -K (V_{O1} - V_{O2}) \end{aligned} \tag{5}$$

Substituting from Equation 4:

$$V_O = -K (2a + 1) (V_1 - V_2) \tag{6}$$

This shows the gain of the instrumentation amplifier to be:

$$-K(2a+1)$$

Typical values for this circuit can be obtained by setting: $a = 12$ and $K = 4$. This results in an overall gain of -100 .

20203436

20203446

SINGLE SUPPLY STRAIN GAUGE BRIDGE AMPLIFIER

Strain gauges are piezoelectric elements used to measure force or pressure. Strain gauges are subjected to an unknown force which is measured as the deflection on a previously calibrated scale. Pressure is often measured using the same technique; however this pressure needs to be converted into force using an appropriate transducer. Strain gauges are often resistors which are sensitive to pressure or to flexing. Sense resistor values range from tens of ohms to several hundred kilo-ohms. The resistance change which is a result of applied force across the strain gauge might be 1% of its total value. An accurate and reliable system is needed to measure this small resistance change. Bridge configurations offer a reliable method for this measurement.

Bridge sensors are formed of four resistors, connected as a quadrilateral. A voltage source or a current source is used across one of the diagonals to excite the bridge while a voltage detector across the other diagonal measures the output voltage.

Bridges are mainly used as null circuits or to measure differential voltages. Bridges will have no output voltage if the ratios

of two adjacent resistor values are equal. This fact is used in null circuit measurements. These are particularly used in feedback systems which involve electrochemical elements or human interfaces. Null systems force an active resistor, such as a strain gauge, to balance the bridge by influencing the measured parameter.

Often in sensor applications at least one of the resistors is a variable resistor, or a sensor. The deviation of this active element from its initial value is measured as an indication of change in the measured quantity. A change in output voltage represents the sensor value change. Since the sensor value change is often very small, the resulting output voltage is very small in magnitude as well. This requires an extensive and very precise amplification circuitry so that signal fidelity does not change after amplification.

Sensitivity of a bridge is the ratio of its maximum expected output change to the excitation voltage change.

Figure 4(a) shows a typical bridge sensor and Figure 4(b) shows the bridge with four sensors. R in Figure 4(b) is the nominal value of the sense resistor and the deviations from R are proportional to the quantity being measured.

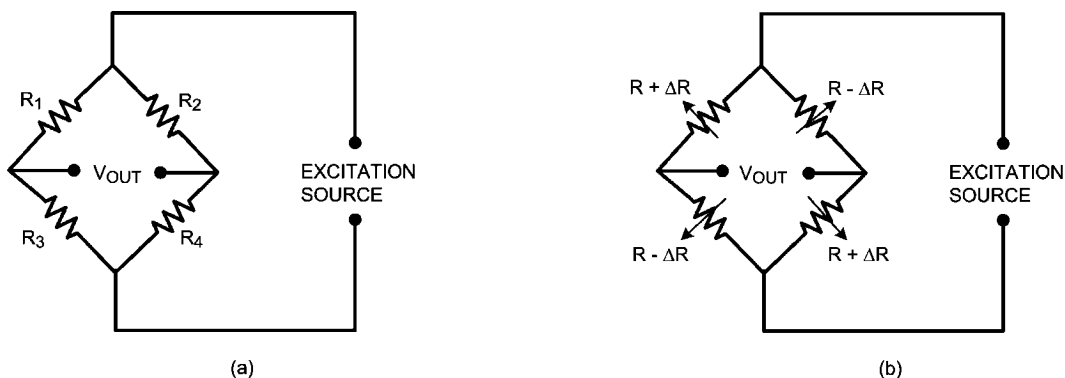

$$V_{OUT} = \frac{\frac{R_3}{R_1} - \frac{R_4}{R_2}}{\left(1 + \frac{R_3}{R_1}\right)\left(1 + \frac{R_4}{R_2}\right)} \times V_{SOURCE}$$

20203450

$$V_{OUT} = \frac{\Delta R}{R} \times V_{SOURCE}$$

20203451

FIGURE 4. Bridge Sensor

Instrumentation amplifiers are great for interfacing with bridge sensors. Bridge sensors often sense a very small differential signal in the presence of a larger common mode voltage. Instrumentation amplifiers reject this common mode signal.

Figure 5 shows a strain gauge bridge amplifier. In this application one of the LMP2234 amplifiers is used to buffer the LM4140A's precision output voltage. The LM4140A is a precision voltage reference. The other three amplifiers in the

LMP2234 are used to form an instrumentation amplifier. This instrumentation amplifier uses the LMP2234's high CMRR and low V_{OS} and TCV_{OS} to accurately amplify the small differential signal generated by the output of the bridge sensor. This amplified signal is then fed into the ADC121S021 which is a 12-bit analog to digital converter. This circuit works on a single supply voltage of 5V.

[查询"LMP2234AMA"供应商](#)

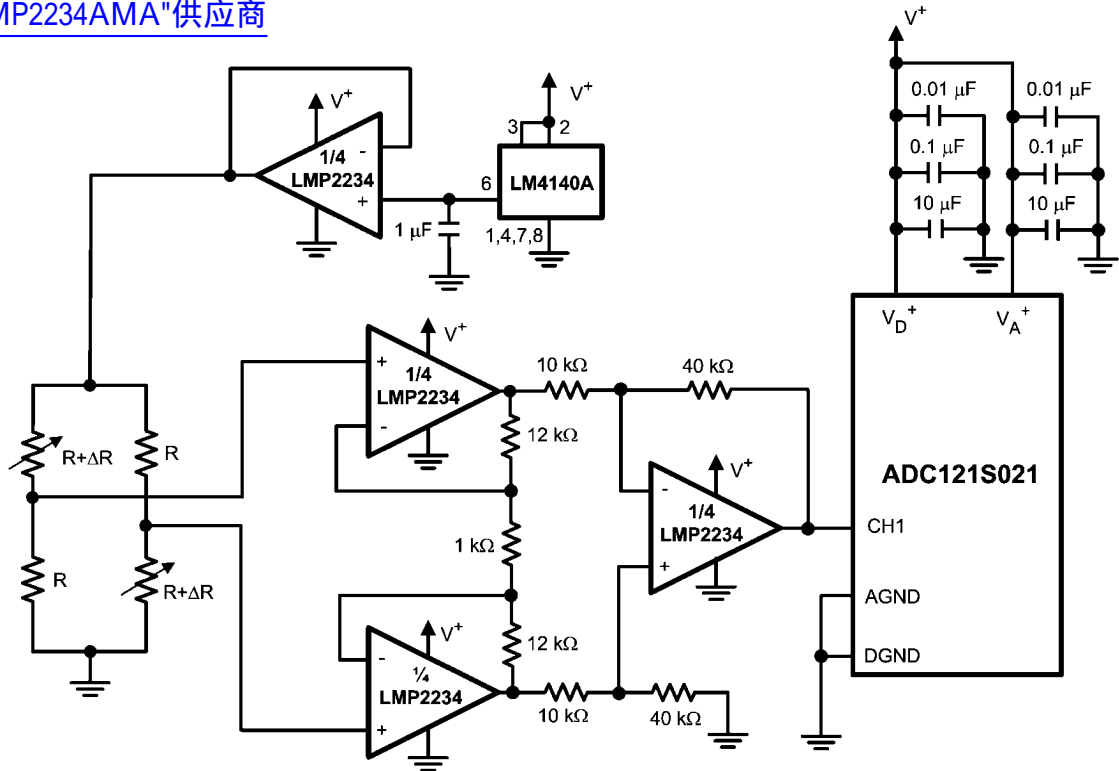

20203468

FIGURE 5. Strain Gauge Bridge Amplifier

PORTABLE GAS DETECTION SENSOR

Gas sensors are used in many different industrial and medical applications. They generate a current which is proportional to the percentage of a particular gas sensed in an air sample. This current goes through a load resistor and the resulting voltage drop is measured. Depending on the sensed gas and sensitivity of the sensor, the output current can be in the order of tens of microamperes to a few milliamperes. Gas sensor datasheets often specify a recommended load resistor value or they suggest a range of load resistors to choose from.

Oxygen sensors are used when air quality or oxygen delivered to a patient needs to be monitored. Fresh air contains 20.9% oxygen. Air samples containing less than 18% oxygen are considered dangerous. Oxygen sensors are also used in industrial applications where the environment must lack oxygen. An example is when food is vacuum packed. There are two main categories of oxygen sensors, those which sense oxygen when it is abundantly present (i.e. in air or near an oxygen tank) and those which detect very small traces of oxygen in ppm.

Figure 6 shows a typical circuit used to amplify the output signal of an oxygen detector. The LMP2234 makes an excellent choice for this application as it draws only 36 μA of current and operates on supply voltages down to 1.8V. This application detects oxygen in air. The oxygen sensor outputs a known current through the load resistor. This value changes with the amount of oxygen present in the air sample. Oxygen sensors usually recommend a particular load resistor value

or specify a range of acceptable values for the load resistor. Oxygen sensors typically have a life of one to two years. The use of the micropower LMP2234 means minimal power usage by the op amp and it enhances the battery life. Depending on other components present in the circuit design, the battery could last for the entire life of the oxygen sensor. The precision specifications of the LMP2234, such as its very low offset voltage, low TCV_{OS} , low input bias current, low CMRR , and low PSRR are other factors which make the LMP2234 a great choice for this application.

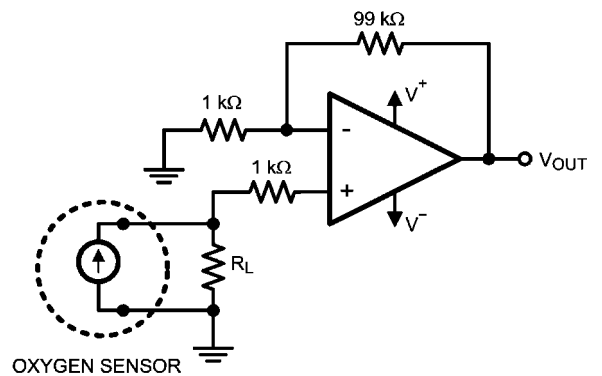

20203449

FIGURE 6. Precision Oxygen Sensor

Physical Dimensions inches (millimeters) unless otherwise noted
[查询"LMP2234AMA"供应商](#)

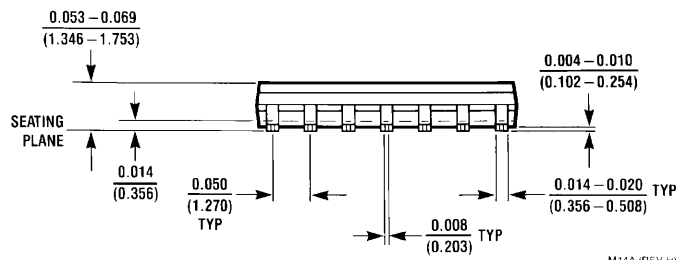
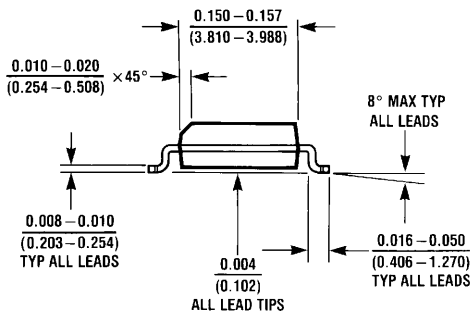
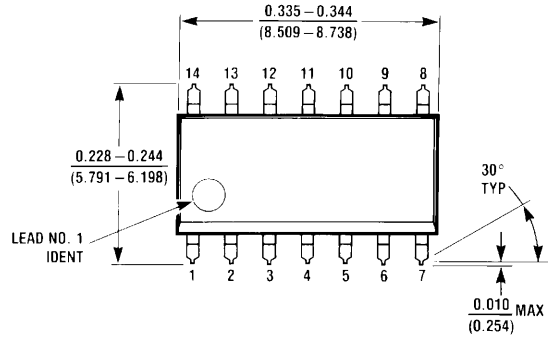

M14A (REV H)

14-Pin SOIC
NS Package Number M14A

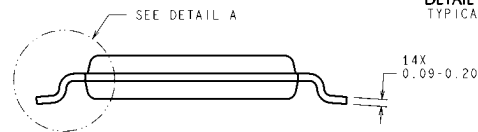
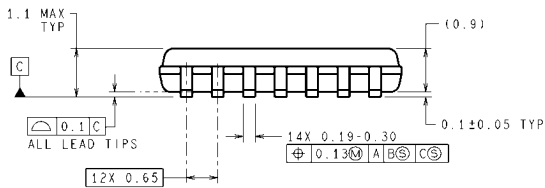
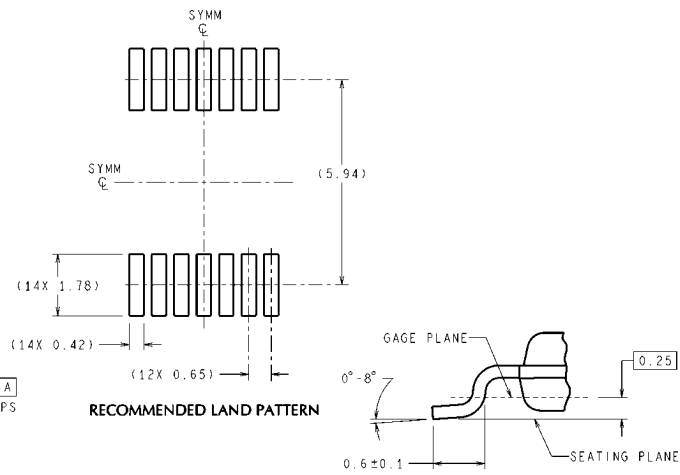
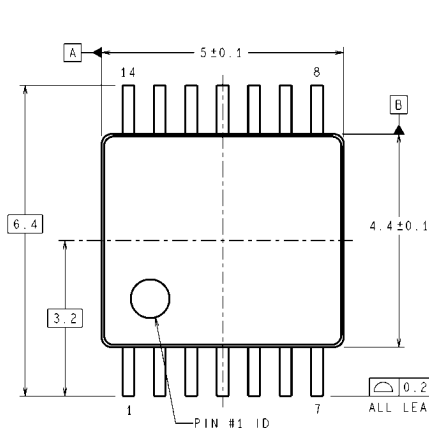

DIMENSIONS ARE IN MILLIMETERS
 DIMENSIONS IN () FOR REFERENCE ONLY

MTC14 (Rev D)

14-Pin TSSOP
NS Package Number MTC14

Notes

THE CONTENTS OF THIS DOCUMENT ARE PROVIDED IN CONNECTION WITH NATIONAL SEMICONDUCTOR CORPORATION ("NATIONAL") PRODUCTS. NATIONAL MAKES NO REPRESENTATIONS OR WARRANTIES WITH RESPECT TO THE ACCURACY OR COMPLETENESS OF THE CONTENTS OF THIS PUBLICATION AND RESERVES THE RIGHT TO MAKE CHANGES TO SPECIFICATIONS AND PRODUCT DESCRIPTIONS AT ANY TIME WITHOUT NOTICE. NO LICENSE, WHETHER EXPRESS, IMPLIED, ARISING BY ESTOPPEL OR OTHERWISE, TO ANY INTELLECTUAL PROPERTY RIGHTS IS GRANTED BY THIS DOCUMENT.

TESTING AND OTHER QUALITY CONTROLS ARE USED TO THE EXTENT NATIONAL DEEMS NECESSARY TO SUPPORT NATIONAL'S PRODUCT WARRANTY. EXCEPT WHERE MANDATED BY GOVERNMENT REQUIREMENTS, TESTING OF ALL PARAMETERS OF EACH PRODUCT IS NOT NECESSARILY PERFORMED. NATIONAL ASSUMES NO LIABILITY FOR APPLICATIONS ASSISTANCE OR BUYER PRODUCT DESIGN. BUYERS ARE RESPONSIBLE FOR THEIR PRODUCTS AND APPLICATIONS USING NATIONAL COMPONENTS. PRIOR TO USING OR DISTRIBUTING ANY PRODUCTS THAT INCLUDE NATIONAL COMPONENTS, BUYERS SHOULD PROVIDE ADEQUATE DESIGN, TESTING AND OPERATING SAFEGUARDS.

EXCEPT AS PROVIDED IN NATIONAL'S TERMS AND CONDITIONS OF SALE FOR SUCH PRODUCTS, NATIONAL ASSUMES NO LIABILITY WHATSOEVER, AND NATIONAL DISCLAIMS ANY EXPRESS OR IMPLIED WARRANTY RELATING TO THE SALE AND/OR USE OF NATIONAL PRODUCTS INCLUDING LIABILITY OR WARRANTIES RELATING TO FITNESS FOR A PARTICULAR PURPOSE, MERCHANTABILITY, OR INFRINGEMENT OF ANY PATENT, COPYRIGHT OR OTHER INTELLECTUAL PROPERTY RIGHT.

LIFE SUPPORT POLICY

NATIONAL'S PRODUCTS ARE NOT AUTHORIZED FOR USE AS CRITICAL COMPONENTS IN LIFE SUPPORT DEVICES OR SYSTEMS WITHOUT THE EXPRESS PRIOR WRITTEN APPROVAL OF THE CHIEF EXECUTIVE OFFICER AND GENERAL COUNSEL OF NATIONAL SEMICONDUCTOR CORPORATION. As used herein:

Life support devices or systems are devices which (a) are intended for surgical implant into the body, or (b) support or sustain life and whose failure to perform when properly used in accordance with instructions for use provided in the labeling can be reasonably expected to result in a significant injury to the user. A critical component is any component in a life support device or system whose failure to perform can be reasonably expected to cause the failure of the life support device or system or to affect its safety or effectiveness.

National Semiconductor and the National Semiconductor logo are registered trademarks of National Semiconductor Corporation. All other brand or product names may be trademarks or registered trademarks of their respective holders.

Copyright© 2007 National Semiconductor Corporation

For the most current product information visit us at www.national.com



**National Semiconductor
Americas Customer
Support Center**
Email:
new.feedback@nsc.com
Tel: 1-800-272-9959

**National Semiconductor Europe
Customer Support Center**
Fax: +49 (0) 180-530-85-86
Email: europe.support@nsc.com
Deutsch Tel: +49 (0) 69 9508 6208
English Tel: +49 (0) 870 24 0 2171
Français Tel: +33 (0) 1 41 91 8790

**National Semiconductor Asia
Pacific Customer Support Center**
Email: ap.support@nsc.com

**National Semiconductor Japan
Customer Support Center**
Fax: 81-3-5639-7507
Email: jpn.feedback@nsc.com
Tel: 81-3-5639-7560