

16-Bit, 170/200-MSPS Analog-to-Digital Converters

Check for Samples: [ADS5484](#) [ADS5485](#)

FEATURES

- 170/200-MSPS Sample Rates
- 16-Bit Resolution, 78 dBFS Noise Floor
- SFDR = 95 dBc
- On-Chip High Impedance Analog Buffer
- Efficient DDR LVDS-Compatible Outputs
- Power-Down Mode: 70 mW
- Pin-for-Pin with ADS5483/5482/5481, 135/105/80-MSPS ADCs
- QFN-64 PowerPAD™ Package (9 mm × 9 mm footprint)
- Industrial Temperature Range: –40°C to 85°C

APPLICATIONS

- Wireless Infrastructure
- Test and Measurement Instrumentation
- Software-Defined Radio
- Data Acquisition
- Power Amplifier Linearization
- Radar
- Medical Imaging

DESCRIPTION

The ADS5484/ADS5485 (ADS548x) is a 16-bit family of analog-to-digital converters (ADCs) that operate from both a 5-V supply and 3.3-V supply while providing LVDS-compatible digital outputs. The ADS548x integrated analog input buffer isolates the internal switching of the onboard track and hold (T & H) from disturbing the signal source while providing a high-impedance input. An internal reference generator is provided to simplify the system design. Internal dither is available to improve SFDR. These devices are drop-in compatible to the ADS5483/5482/5481, creating a pin-compatible family from 80 – 200 MSPS. Designed for highest total ENOB, the ADS548x family has outstanding low noise performance and spurious-free dynamic range.

The ADS548x family is available in a QFN-64 PowerPAD package. The devices are built on Texas Instruments complementary bipolar process (BiCom3) and are specified over the full industrial temperature range (–40°C to 85°C).

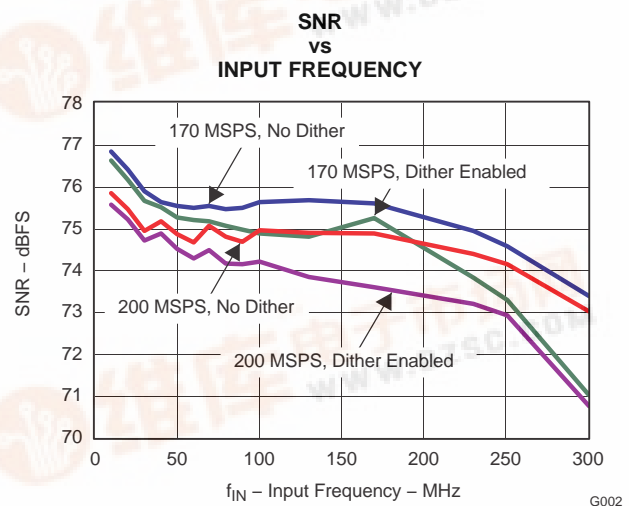
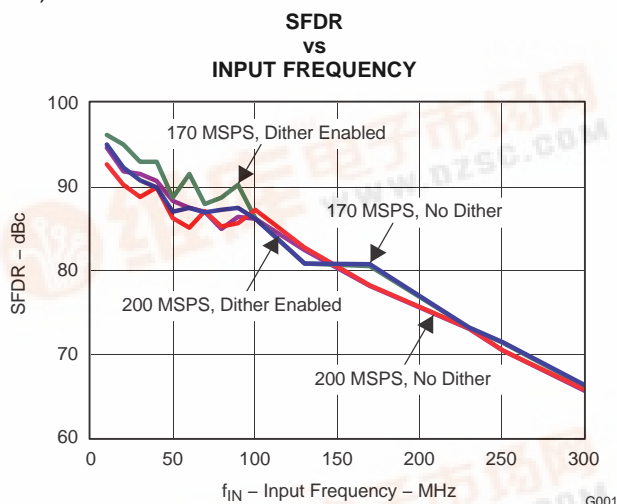

Please be aware that an important notice concerning availability, standard warranty, and use in critical applications of Texas Instruments semiconductor products and disclaimers thereto appears at the end of this data sheet.

PowerPAD is a trademark of Texas Instruments.

All other trademarks are the property of their respective owners.

PRODUCTION DATA information is current as of publication date. Products conform to specifications per the terms of the Texas Instruments standard warranty. Production processing does not necessarily include testing of all parameters.

Copyright © 2008–2009, Texas Instruments Incorporated





This integrated circuit can be damaged by ESD. Texas Instruments recommends that all integrated circuits be handled with appropriate precautions. Failure to observe proper handling and installation procedures can cause damage.

ESD damage can range from subtle performance degradation to complete device failure. Precision integrated circuits may be more susceptible to damage because very small parametric changes could cause the device not to meet its published specifications.

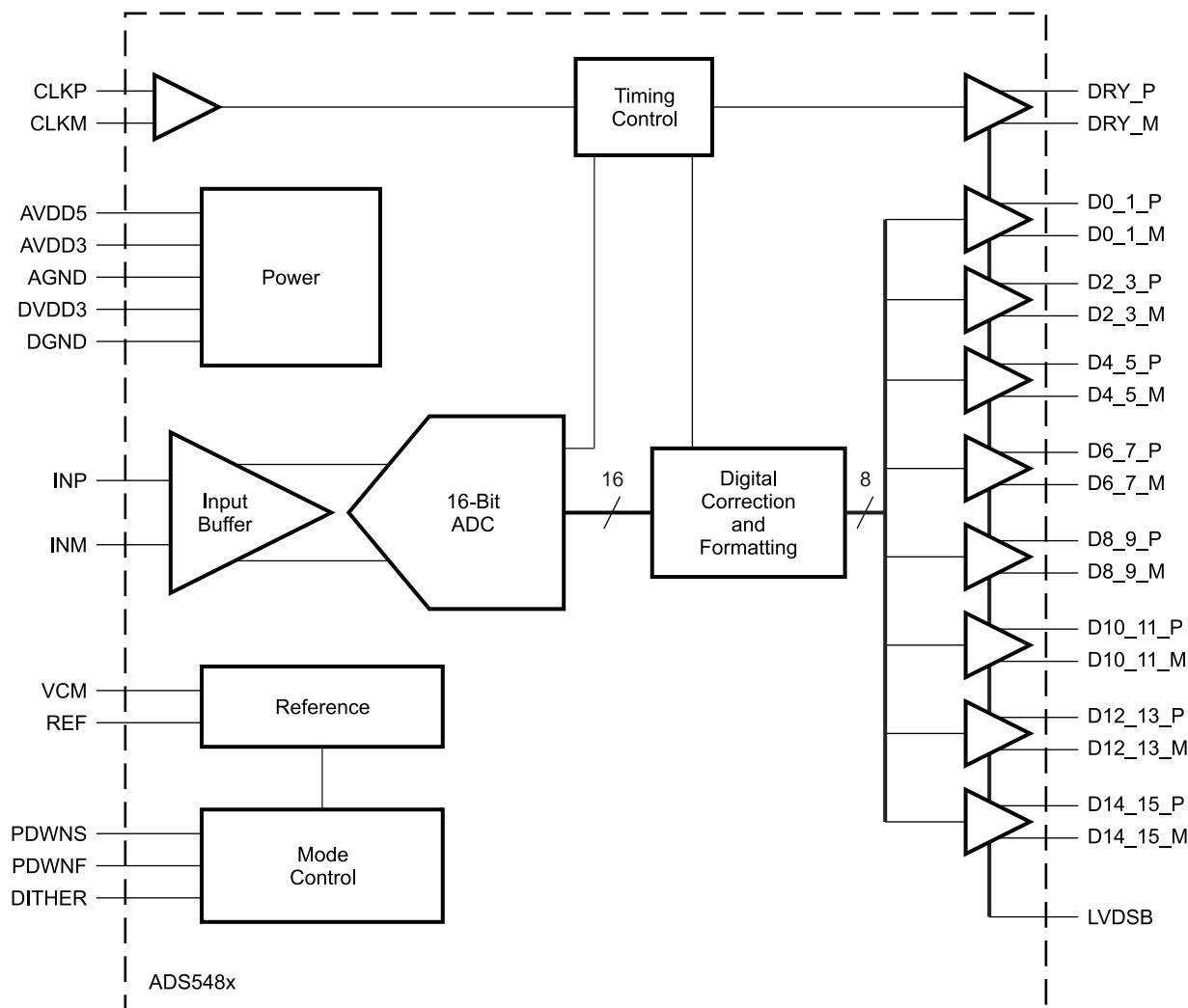

B0095-03

Table 1. PACKAGE/ORDERING INFORMATION⁽¹⁾

| PRODUCT | PACKAGE-LEAD | PACKAGE DESIGNATOR | SPECIFIED TEMPERATURE RANGE | PACKAGE MARKING | ORDERING NUMBER | TRANSPORT MEDIA, QUANTITY |
|---------|--------------|--------------------|-----------------------------|-----------------|-----------------|---------------------------|
| ADS5484 | QFN-64 | RGC | -40°C to 85°C | AZ5484 | ADS5484IRGCT | Tape and reel, 250 |
| | | | | | ADS5484IRGCR | Tape and reel, 2000 |
| ADS5485 | QFN-64 | RGC | -40°C to 85°C | AZ5485 | ADS5485IRGCT | Tape and reel, 250 |
| | | | | | ADS5485IRGCR | Tape and reel, 2000 |

(1) For the most current product and ordering information see the Package Option Addendum located at the end of this document, or see the TI website at www.ti.com..

ABSOLUTE MAXIMUM RATINGS⁽¹⁾

Over operating free-air temperature range, unless otherwise noted.

| | | ADS5484, ADS5485 | UNIT |
|-----------------------------------|--|-----------------------|------|
| Supply voltage | AVDD5 to GND | 6 | V |
| | AVDD3 to GND | 5 | V |
| | DVDD3 to GND | 5 | V |
| Analog input to GND | AC signal. Valid when AVDD5 is within normal operating range. When AVDD5 is off, analog inputs should be < 0.5 V. If not, the protection diode between the inputs and AVDD5 becomes forward-biased and could be damaged or shorten device lifetime (see Figure 30). Short transient conditions during power on/off are not a concern. | –0.3 to (AVDD5 + 0.3) | V |
| Analog INP to INM | DC signal | ±4 | V |
| Clock input to GND | Valid when AVDD3 is within normal operating range. When AVDD3 is off, clock inputs should be < 0.5 V. If not, the protection diode between the inputs and AVDD3 becomes forward-biased and could be damaged or shorten device lifetime (see Figure 37). Short transient conditions during power on/off are not a concern. | –0.3 to (AVDD3 + 0.3) | V |
| CLKP to CLKM | | ±2.5 | V |
| Digital data output to GND | | –0.3 to (DVDD3 + 0.3) | V |
| Digital data output plus-to-minus | | ±1 | V |
| Operating temperature range | | –40 to 85 | °C |
| Maximum junction temperature | | 150 | °C |
| Storage temperature range | | –65 to 150 | °C |
| ESD, human-body model (HBM) | | 2 | kV |

- (1) Stresses above these ratings may cause permanent damage. Exposure to absolute maximum conditions for extended periods may degrade device reliability. These are stress ratings only, and functional operation of the device at these or any other conditions beyond those specified is not implied. Kirkendall voidings and current density information for calculation of expected lifetime are available upon request.

THERMAL CHARACTERISTICS⁽¹⁾

| PARAMETER | TEST CONDITIONS | TYP | UNIT |
|------------------|--|-----|------|
| R _{θJA} | Soldered thermal pad, no airflow | 20 | °C/W |
| | Soldered thermal pad, 150-LFM airflow | 16 | |
| R _{θJC} | Thermal resistance from the junction to the package case (top) | 7 | |
| R _{θJP} | Thermal resistance from the junction to the thermal pad (bottom) | 0.2 | |

- (1) Using 49 thermal vias (7 × 7 array). See *PowerPAD Package* in the Application Information section.

RECOMMENDED OPERATING CONDITIONS

| | | ADS5484, ADS5485 | | | UNIT |
|--|--------------------------------|------------------|-----|-----------------|-----------------|
| | | MIN | NOM | MAX | |
| SUPPLIES | | | | | |
| AVDD5 | Analog supply voltage | 4.75 | 5 | 5.25 | V |
| AVDD3 | Analog supply voltage | 3.15 | 3.3 | 3.45 | V |
| DVDD3 | Output driver supply voltage | 3 | 3.3 | 3.6 | V |
| ANALOG INPUT | | | | | |
| Differential input voltage range | | 3 | | | V _{PP} |
| VCM | Input common-mode voltage | 3.1 | | | V |
| DIGITAL OUTPUT (DRY, DATA) | | | | | |
| Maximum differential output load (parasitic or intentional) | | 5 | | | pF |
| Differential output resistance | | 100 | | | Ω |
| CLOCK INPUT (CLK) | | | | | |
| CLK input sample rate (sine wave) | | 10 | | Max Rated Clock | MSPS |
| Clock amplitude, differential sine wave (see Figure 39) | | 1.5 | | 5 | V _{PP} |
| Clock duty cycle (see Figure 44) | | 45% | 50% | 55% | |
| T _A | Operating free-air temperature | -40 | | +85 | °C |

ELECTRICAL CHARACTERISTICS (ADS5484, ADS5485)

Typical values at T_A = 25°C: minimum and maximum values over full temperature range T_{MIN} = -40°C to T_{MAX} = 85°C, sampling rate = max rated, 50% clock duty cycle, AVDD5 = 5 V, AVDD3 = 3.3 V, DVDD3 = 3.3 V, -1 dBFS differential input, and 3-V_{PP} differential clock, unless otherwise noted.

| PARAMETER | TEST CONDITIONS | ADS5484 | | | ADS5485 | | | UNIT | | | |
|-----------------------------------|---|--|-----|-----|---------|-----|-----|-----------------|-----|-----|---|
| | | MIN | TYP | MAX | MIN | TYP | MAX | | | | |
| Clock rate | | | | 170 | | | 200 | MSPS | | | |
| Resolution | | | | 16 | | | 16 | Bits | | | |
| ANALOG INPUTS | | | | | | | | | | | |
| Differential input voltage range | | 3 | | | 3 | | | V _{PP} | | | |
| Analog input common-mode voltage | | Self-biased; see VCM specification below | | | 3.1 | | | V | | | |
| Input resistance (dc) | | Each input to VCM | | | 1000 | | | Ω | | | |
| Input capacitance | | Each input to GND (unsoldered package) | | | 3.5 | | | pF | | | |
| Analog input bandwidth (-3dB) | | 730 | | | 730 | | | MHz | | | |
| CMRR | Common-mode rejection ratio | Common-mode signal 70 MHz (see Figure 26) | | | 65 | | | 65 | dB | | |
| INTERNAL REFERENCE VOLTAGE | | | | | | | | | | | |
| VREF | Reference voltage | 1.2 | | | 1.2 | | | V | | | |
| VCM | Analog input common-mode voltage reference output | With internal voltage reference | | | 2.9 | 3.1 | 3.3 | 2.9 | 3.1 | 3.3 | V |
| VCM temperature coefficient | | -1 | | | -1 | | | mV/°C | | | |

ELECTRICAL CHARACTERISTICS (ADS5484, ADS5485) (continued)

Typical values at $T_A = 25^\circ\text{C}$: minimum and maximum values over full temperature range $T_{\text{MIN}} = -40^\circ\text{C}$ to $T_{\text{MAX}} = 85^\circ\text{C}$, sampling rate = max rated, 50% clock duty cycle, AVDD5 = 5 V, AVDD3 = 3.3 V, DVDD3 = 3.3 V, -1 dBFS differential input, and 3- V_{PP} differential clock, unless otherwise noted.

| PARAMETER | | TEST CONDITIONS | ADS5484 | | | ADS5485 | | | UNIT |
|-----------------------------------|--|--|---------|-----------|-----|---------|-----------|-----|---------------|
| | | | MIN | TYP | MAX | MIN | TYP | MAX | |
| DYNAMIC ACCURACY | | | | | | | | | |
| DNL | Differential nonlinearity error | No missing codes, $f_{\text{IN}} = 30\text{ MHz}$ | -0.99 | ± 0.5 | 1.0 | -0.99 | ± 0.5 | 1.0 | LSB |
| INL | Integral nonlinearity error | $f_{\text{IN}} = 30\text{ MHz}$ | -10 | ± 3 | +10 | -10 | ± 3 | +10 | LSB |
| | Offset error | | -15 | | 15 | -15 | | 15 | mV |
| | Offset temperature coefficient | | | -0.02 | | | -0.02 | | mV/°C |
| | Gain error | | -6 | ± 2 | 6 | -6 | ± 2 | 6 | %FS |
| | Gain temperature coefficient | | | -0.01 | | | -0.01 | | mV/°C |
| POWER SUPPLY | | | | | | | | | |
| I_{AVDD5} | 5-V analog current | $V_{\text{IN}} = \text{Full-scale}, f_{\text{IN}} = 30\text{ MHz},$ $f_{\text{S}} = \text{Max rated, Normal operation}$ | 310 | 330 | | 310 | 330 | | mA |
| I_{AVDD3} | 3.3-V analog current | | 126 | 150 | | 126 | 150 | | mA |
| I_{DVDD3} | 3.3-V digital/LVDS current | | 60 | 65 | | 60 | 65 | | mA |
| | Total power dissipation | | 2.16 | 2.35 | | 2.16 | 2.35 | | W |
| I_{AVDD5} | 5-V analog current | Light sleep mode (PDWNF = H, PDWNS = L) | 98 | | | 98 | | | mA |
| I_{AVDD3} | 3.3-V analog current | | 35 | | | 35 | | | mA |
| I_{DVDD3} | 3.3-V digital/LVDS current | | 0.07 | | | 0.07 | | | mA |
| | Total power dissipation | | 600 | 680 | | 600 | 680 | | mW |
| I_{AVDD5} | 5-V analog current | Deep sleep mode (PDWNF = L, PDWNS = H) | 13 | | | 13 | | | mA |
| I_{AVDD3} | 3.3-V analog current | | 1 | | | 1 | | | mA |
| I_{DVDD3} | 3.3-V digital/LVDS current | | 0.07 | | | 0.07 | | | mA |
| | Total power dissipation | | 70 | 100 | | 70 | 100 | | mW |
| | Fast wake-up time (light sleep) | From PDWNF disabled | 600 | | | 600 | | | μs |
| | Slow wake-up time (deep sleep) | From PDWNS disabled | 6 | | | 6 | | | mS |
| PSRR | AVDD5 supply | Power-supply rejection ratio, Without 0.1- μF board supply capacitors, with 1-MHz supply noise (see Figure 46) | 60 | | | 60 | | | dB |
| | AVDD3 supply | | 80 | | | 80 | | | dB |
| | DVDD3 supply | | 95 | | | 95 | | | dB |
| DYNAMIC AC CHARACTERISTICS | | | | | | | | | |
| SNR | Signal-to-noise ratio, dither disabled | $f_{\text{IN}} = 10\text{ MHz}$ | 75 | 76.8 | | 73.5 | 75.8 | | dBFS |
| | | $f_{\text{IN}} = 30\text{ MHz}$ | 74.5 | 75.9 | | 73 | 75 | | |
| | | $f_{\text{IN}} = 70\text{ MHz}$ | | 75.7 | | | 75 | | |
| | | $f_{\text{IN}} = 130\text{ MHz}$ | 73.5 | 75.7 | | 72 | 74.8 | | |
| | | $f_{\text{IN}} = 170\text{ MHz}$ | | 75.6 | | | 74.8 | | |
| | | $f_{\text{IN}} = 230\text{ MHz}$ | | 74.9 | | | 74.4 | | |
| SFDR | Spurious-free dynamic range, dither disabled | $f_{\text{IN}} = 10\text{ MHz}$ | 84 | 95 | | 84 | 93 | | dBc |
| | | $f_{\text{IN}} = 30\text{ MHz}$ | 84 | 91 | | 82 | 90 | | |
| | | $f_{\text{IN}} = 70\text{ MHz}$ | | 87 | | | 87 | | |
| | | $f_{\text{IN}} = 130\text{ MHz}$ | 78 | 86 | | 78 | 85 | | |
| | | $f_{\text{IN}} = 170\text{ MHz}$ | | 81 | | | 78 | | |
| | | $f_{\text{IN}} = 230\text{ MHz}$ | | 73 | | | 73 | | |
| HD2 | Second-harmonic, dither disabled | $f_{\text{IN}} = 10\text{ MHz}$ | 84 | 100 | | 84 | 100 | | dBc |
| | | $f_{\text{IN}} = 30\text{ MHz}$ | 84 | 95 | | 82 | 95 | | |
| | | $f_{\text{IN}} = 70\text{ MHz}$ | | 95 | | | 95 | | |
| | | $f_{\text{IN}} = 130\text{ MHz}$ | 78 | 87 | | 78 | 85 | | |
| | | $f_{\text{IN}} = 170\text{ MHz}$ | | 81 | | | 78 | | |
| | | $f_{\text{IN}} = 230\text{ MHz}$ | | 73 | | | 73 | | |

ELECTRICAL CHARACTERISTICS (ADS5484, ADS5485) (continued)

Typical values at $T_A = 25^\circ\text{C}$: minimum and maximum values over full temperature range $T_{\text{MIN}} = -40^\circ\text{C}$ to $T_{\text{MAX}} = 85^\circ\text{C}$, sampling rate = max rated, 50% clock duty cycle, AVDD5 = 5 V, AVDD3 = 3.3 V, DVDD3 = 3.3 V, -1 dBFS differential input, and 3- V_{PP} differential clock, unless otherwise noted.

| PARAMETER | TEST CONDITIONS | ADS5484 | | | ADS5485 | | | UNIT | |
|-----------------------------|---|---|-------|------|---------|-------|---------|-------|---------------|
| | | MIN | TYP | MAX | MIN | TYP | MAX | | |
| HD3 | Third-harmonic, dither disabled | $f_{\text{IN}} = 10 \text{ MHz}$ | 84 | 97 | 84 | 99 | dBc | | |
| | | $f_{\text{IN}} = 30 \text{ MHz}$ | 84 | 91 | 82 | 87 | | | |
| | | $f_{\text{IN}} = 70 \text{ MHz}$ | | 87 | | 87 | | | |
| | | $f_{\text{IN}} = 130 \text{ MHz}$ | 78 | 86 | 78 | 85 | | | |
| | | $f_{\text{IN}} = 170 \text{ MHz}$ | | 82 | | 81 | | | |
| | | $f_{\text{IN}} = 230 \text{ MHz}$ | | 73 | | 73 | | | |
| | Worst harmonic/spur (other than HD2 and HD3), dither disabled | $f_{\text{IN}} = 10 \text{ MHz}$ | 84 | 96 | 84 | 93 | dBc | | |
| | | $f_{\text{IN}} = 30 \text{ MHz}$ | 84 | 91 | 82 | 90 | | | |
| | | $f_{\text{IN}} = 70 \text{ MHz}$ | | 90 | | 90 | | | |
| | | $f_{\text{IN}} = 130 \text{ MHz}$ | 78 | 91 | 78 | 90 | | | |
| | | $f_{\text{IN}} = 170 \text{ MHz}$ | | 90 | | 90 | | | |
| | | $f_{\text{IN}} = 230 \text{ MHz}$ | | 87 | | 87 | | | |
| THD | Total harmonic distortion, dither disabled | $f_{\text{IN}} = 10 \text{ MHz}$ | 81 | 92 | 81 | 92 | dBc | | |
| | | $f_{\text{IN}} = 30 \text{ MHz}$ | 81 | 86 | 79 | 85 | | | |
| | | $f_{\text{IN}} = 70 \text{ MHz}$ | | 86 | | 85 | | | |
| | | $f_{\text{IN}} = 130 \text{ MHz}$ | 75 | 84 | 75 | 81 | | | |
| | | $f_{\text{IN}} = 170 \text{ MHz}$ | | 78 | | 76 | | | |
| | | $f_{\text{IN}} = 230 \text{ MHz}$ | | 70 | | 70 | | | |
| SINAD | Signal-to-noise and distortion, dither disabled | $f_{\text{IN}} = 10 \text{ MHz}$ | 73.5 | 75.8 | 71.5 | 74.6 | dBc | | |
| | | $f_{\text{IN}} = 30 \text{ MHz}$ | 73 | 75 | 71 | 73.8 | | | |
| | | $f_{\text{IN}} = 70 \text{ MHz}$ | | 74.3 | | 73.7 | | | |
| | | $f_{\text{IN}} = 130 \text{ MHz}$ | 71.5 | 73.8 | 70 | 72.9 | | | |
| | | $f_{\text{IN}} = 170 \text{ MHz}$ | | 72.9 | | 71.7 | | | |
| | | $f_{\text{IN}} = 230 \text{ MHz}$ | | 68.7 | | 68.4 | | | |
| IMD | Two-tone SFDR (worst spurious or IMD) | $f_{\text{IN1}} = 29.5 \text{ MHz}, f_{\text{IN2}} = 30.5 \text{ MHz},$ Each at -7 dBFS | | 99.1 | | 95.9 | dBFS | | |
| | | $f_{\text{IN1}} = 69.5 \text{ MHz}, f_{\text{IN2}} = 70.5 \text{ MHz},$ Each at -10 dBFS | | 95.3 | | 95.2 | | | |
| ENOB | Effective number of bits | $f_{\text{IN}} = 10 \text{ MHz}$ (from SINAD in dBc at -1dBFS) | 11.92 | 12.3 | 11.58 | 12.1 | Bits | | |
| Noise | RMS idle-channel noise | Analog inputs shorted together | | 2.9 | | 2.9 | LSB rms | | |
| | | | | | 78 | | 78 | dBFS | |
| LVDS DIGITAL OUTPUTS | | | | | | | | | |
| V_{OD} | Differential output voltage (\pm) | Assumes a 100- Ω differential load on each LVDS pair and LVDS bias = 3.5 mA | 247 | 350 | 454 | 247 | 350 | 454 | mV |
| V_{OC} | Common-mode output voltage | | 1.125 | 1.25 | 1.375 | 1.125 | 1.25 | 1.375 | V |
| DIGITAL INPUTS | | | | | | | | | |
| V_{IH} | High-level input voltage | PDWNF, PDWNS, DITHER | 2 | | | 2 | | | V |
| V_{IL} | Low-level input voltage | | 0.8 | | | 0.8 | | | V |
| I_{IH} | High-level input current | | 1 | | | 1 | | | μA |
| I_{IL} | Low-level input current | | -1 | | | -1 | | | μA |
| | Input capacitance | | 2 | | | 2 | | | pF |

TIMING INFORMATION

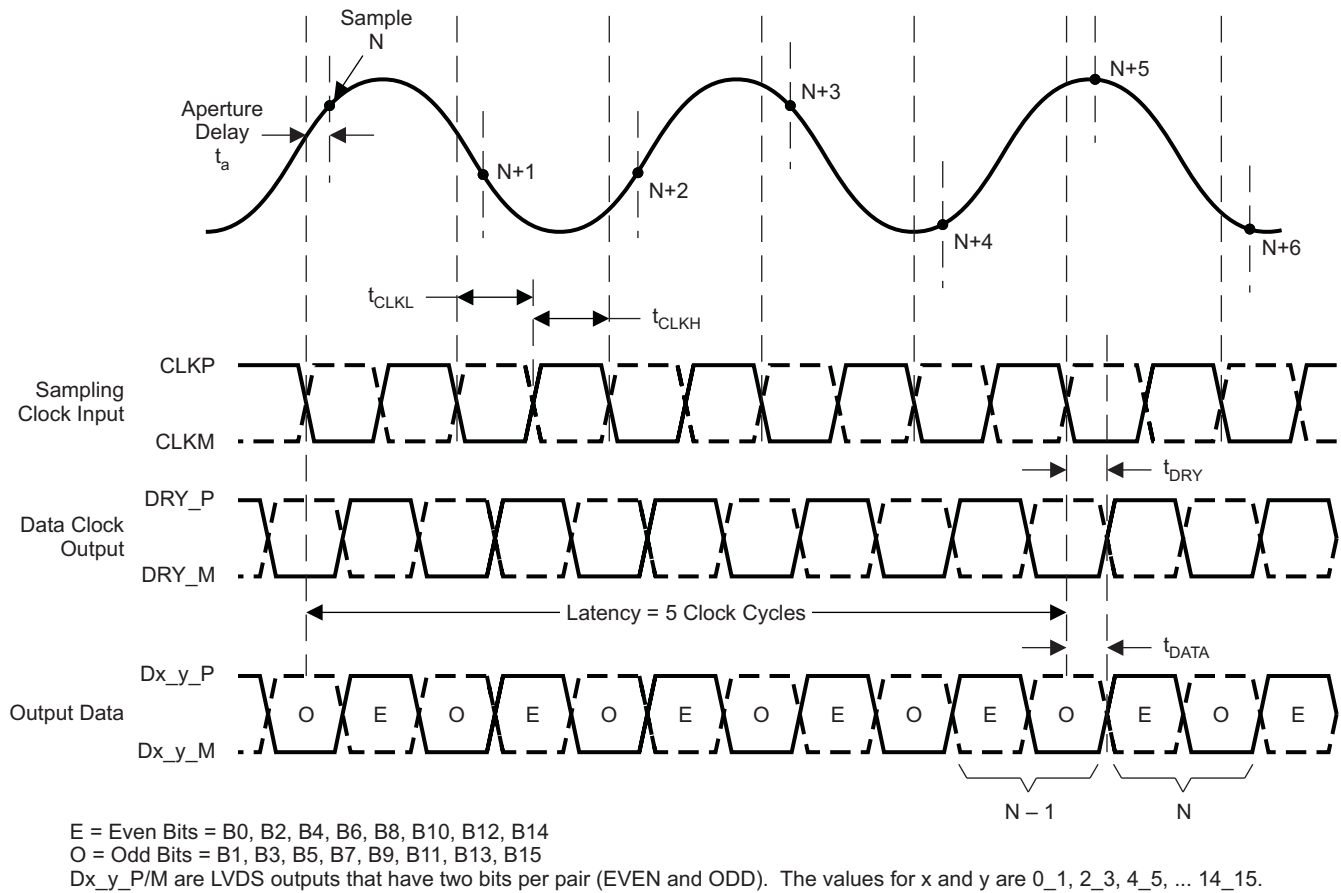

T0158-02

Figure 1. Timing Diagram

TIMING CHARACTERISTICS⁽¹⁾

Typical values at T_A = 25°C: minimum and maximum values over full temperature range T_{MIN} = -40°C to T_{MAX} = 85°C, sampling rate = max rated, 50% clock duty cycle, AVDD5 = 5 V, AVDD3 = 3.3 V, DVDD3 = 3.3 V, and 3-V_{PP} differential clock, unless otherwise noted.

| PARAMETER | TEST CONDITIONS | MIN | TYP | MAX | UNIT |
|-------------------|---------------------------------------|--|-----|------|--------|
| t _a | Aperture delay | | 200 | | ps |
| | Aperture jitter, rms | Internal jitter of the ADC | | 80 | fs |
| | Latency | | 5 | | cycles |
| t _{CLK} | Clock period | 1e9/CLK | | 100 | ns |
| t _{CLKH} | Clock pulse duration, high | CLK = max rated clock for that part number | | 50 | ns |
| t _{CLKL} | Clock pulse duration, low | 0.5e9/CLK | | 50 | ns |
| t _{DRY} | CLK to DRY delay time ⁽²⁾ | Zero crossing, 5-pF parasitic to GND | | 2300 | ps |
| t _{DATA} | CLK to DATA delay time ⁽²⁾ | | | 2400 | ps |
| t _{SKEW} | DATA to DRY skew | t _{DATA} - t _{DRY} , 5-pF parasitic to GND | | 500 | ps |
| t _{RISE} | DRY/DATA rise time | 5-pF parasitic to GND | | 500 | ps |
| t _{FALL} | DRY/DATA fall time | | | 500 | ps |

(1) Timing parameters are assured by design or characterization, but not production tested.

(2) DRY and DATA are updated on the rising edge of CLK input. The latency must be added to t_{DATA} to determine the overall propagation delay.

[查询ADS5485 代理商](#)

PIN CONFIGURATION

ADS548x
RGC Package
(Top View)

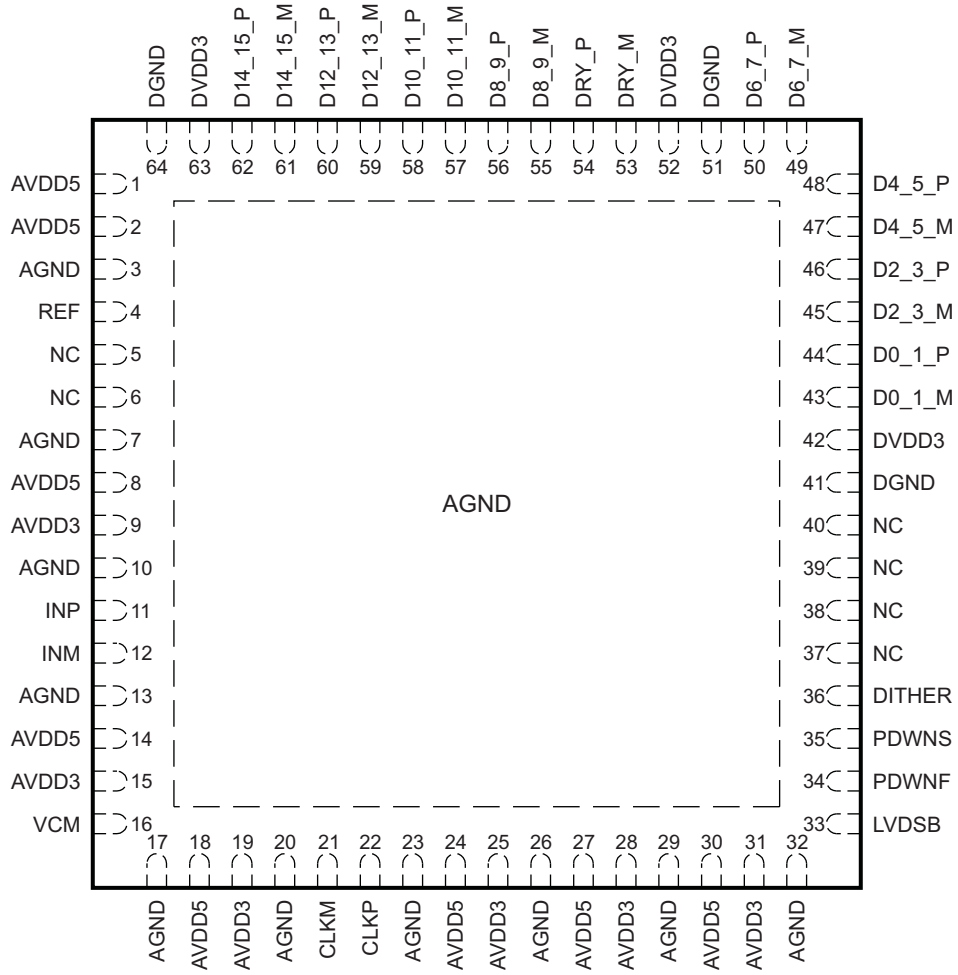

P0056-08

Table 2. PIN FUNCTIONS

| PIN | | DESCRIPTION |
|-----------------------|--------------------------------------|---|
| NAME | NO. | |
| AVDD5 | 1, 2, 8, 14, 18, 24, 27, 30 | 5-V analog supply |
| AVDD3 | 9, 15, 19, 25, 28, 31 | 3.3-V analog supply |
| AGND | 3, 7, 10, 13, 17, 20, 23, 26, 29, 32 | Analog ground |
| DVDD3 | 42, 52, 63 | 3.3-V digital supply |
| DGND | 41, 51, 64 | Digital ground |
| NC | 5, 6, 37-40 | No connect - leave floating |
| INP, INM | 11, 12 | Differential analog inputs (P = plus = true, M = minus = complement) |
| CLKM, CLKP | 21, 22 | Differential clock inputs (P = plus = true, M = minus = complement) |
| REF | 4 | Reference voltage input/output (1.2 V nominal). To use an external reference and to turn the internal reference off, pull both PDWNF and PDWNS to logic high (DVDD3). A 0.1- μ F capacitor to ground on REF is recommended but not required. |
| VCM | 16 | Analog input common mode, output (3.1V), for use in applications that require use of the internally generated common-mode. See the Applications section for more information on using VCM. A 0.1- μ F capacitor to ground on VCM is recommended but not required. |
| LVDSB | 33 | External bias resistor for LVDS bias current, normally 10 k Ω to GND to provide nominal 3.5-mA LVDS current. |
| PDWNF | 34 | Light sleep power down, fast wake-up, logic high (DVDD3) = light sleep enabled (bandgap reference remains on) |
| PDWNS | 35 | Deep sleep power down, slow wake-up, logic high (DVDD3) = deep sleep enabled (bandgap reference is off) |
| DITHER | 36 | Dither enable, logic high (DVDD3) = dither enabled |
| DRY_P, DRY_M | 54, 53 | Data ready signal (LVDS clock out) (P = plus = true, M = minus = complement) |
| D14_15_P, D14_15_M | 62, 61 | DDR LVDS output bits 14 then 15 (15 is MSB) (P = plus = true, M = minus = complement) |
| DE_O_P, DE_O_M | 43-50, 55-62 | DDR LVDS output bits E (even) then O (odd) (P = plus = true, M = minus = complement) |
| D0_1_P, D0_1_M | 44, 43 | DDR LVDS output bits 0 then 1 (0 is LSB) (P = plus = true, M = minus = complement) |
| PowerPAD | 65 | Analog ground (exposed pad on bottom of package) |

TYPICAL CHARACTERISTICS

At $T_A = 25^\circ\text{C}$, sampling rate = max rated, 50% clock duty cycle, $3-V_{PP}$ differential sinusoidal clock, analog input amplitude = -1 dBFS, AVDD5 = 5 V, AVDD3 = 3.3 V, and DVDD3 = 3.3 V, unless otherwise noted.

ADS5484 - 170-MSPS Typical Data

Plots in this section are with a clock of 170 MSPS, unless otherwise specified.

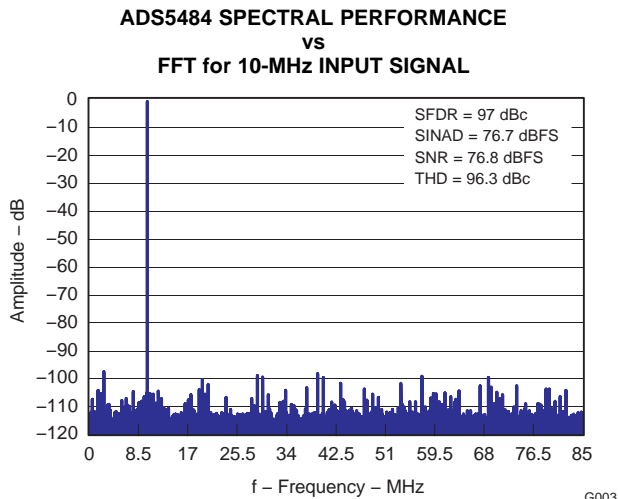

Figure 2.

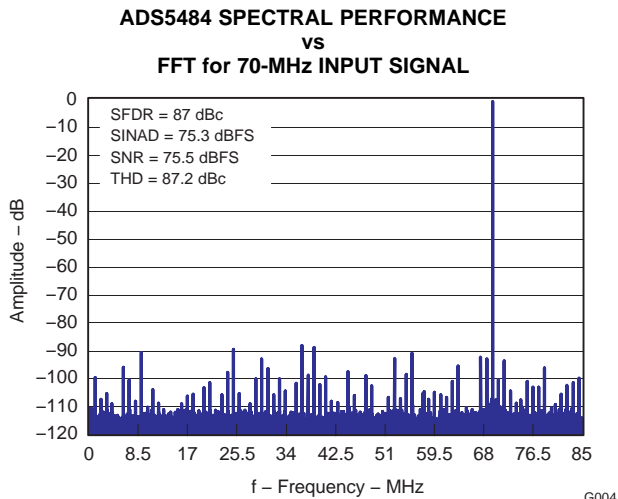

Figure 3.

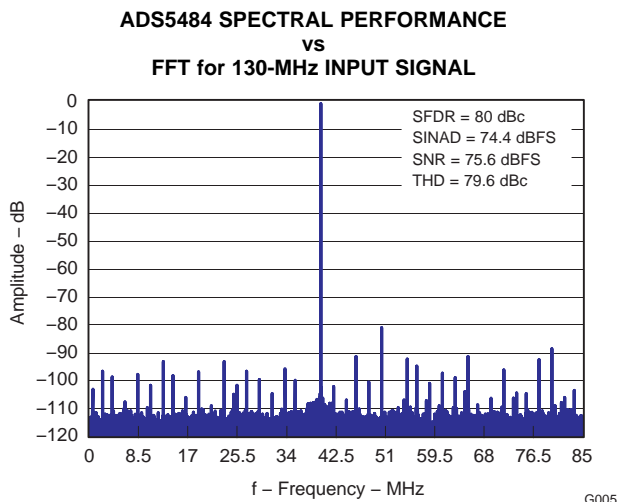

Figure 4.

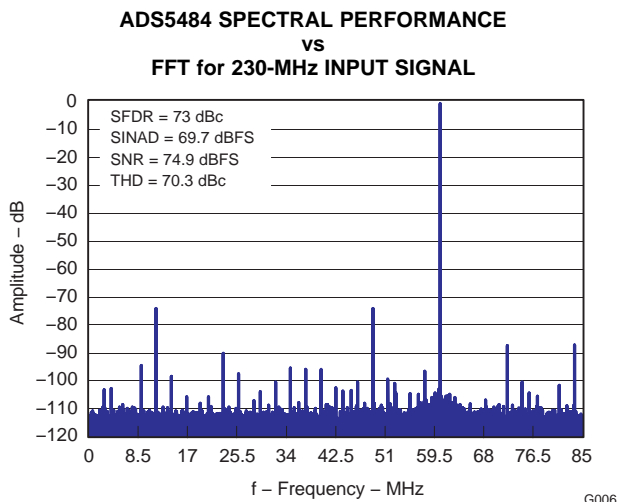

Figure 5.

TYPICAL CHARACTERISTICS (continued)

At $T_A = 25^\circ\text{C}$, sampling rate = max rated, 50% clock duty cycle, 3- V_{PP} differential sinusoidal clock, analog input amplitude = -1 dBFS, AVDD5 = 5 V, AVDD3 = 3.3 V, and DVDD3 = 3.3 V, unless otherwise noted.

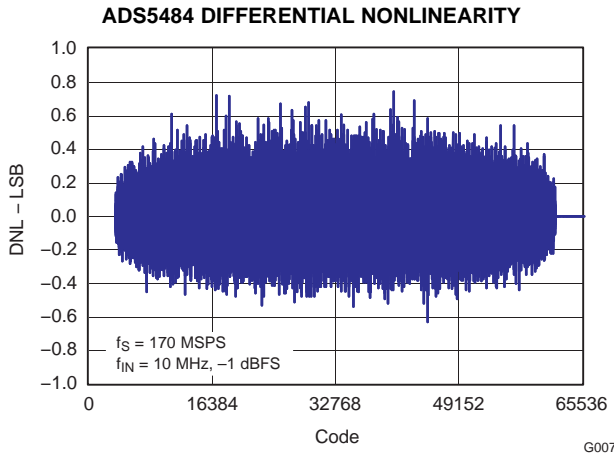

Figure 6.

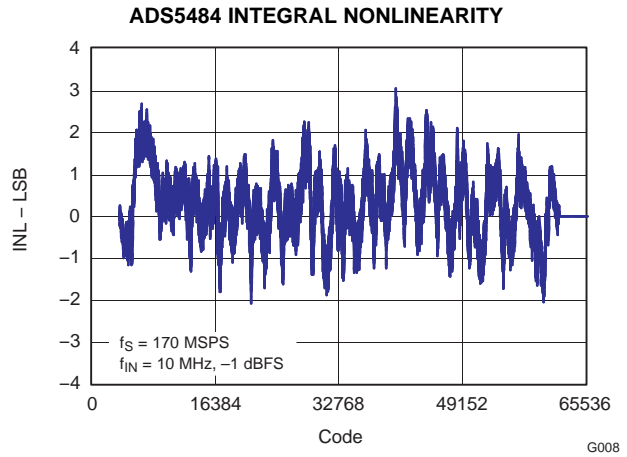

Figure 7.

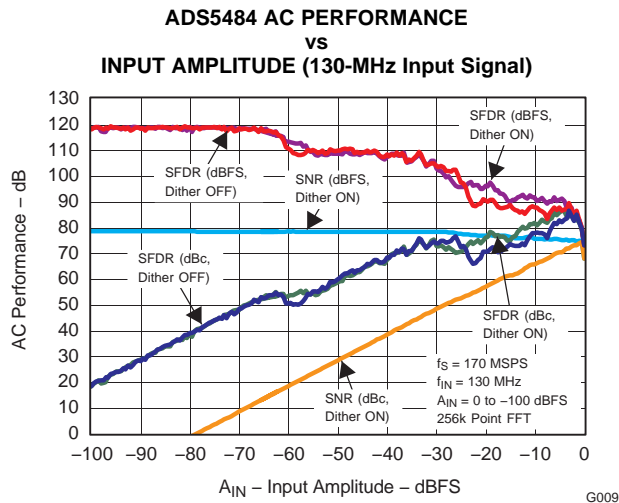

Figure 8.

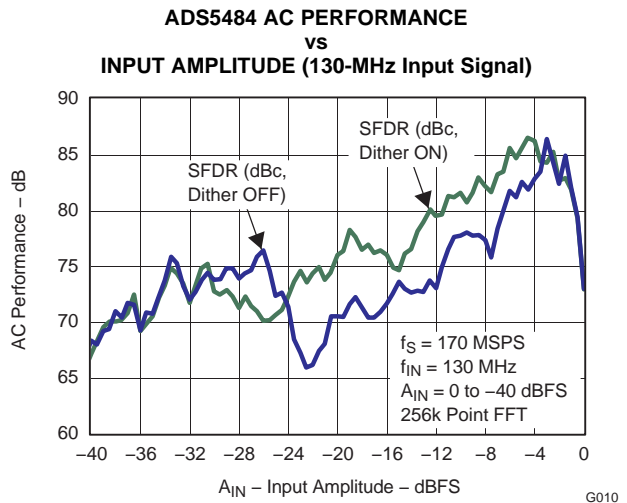

Figure 9.

TYPICAL CHARACTERISTICS (continued)

At $T_A = 25^\circ\text{C}$, sampling rate = max rated, 50% clock duty cycle, 3- V_{PP} differential sinusoidal clock, analog input amplitude = -1 dBFS, AVDD5 = 5 V, AVDD3 = 3.3 V, and DVDD3 = 3.3 V, unless otherwise noted.

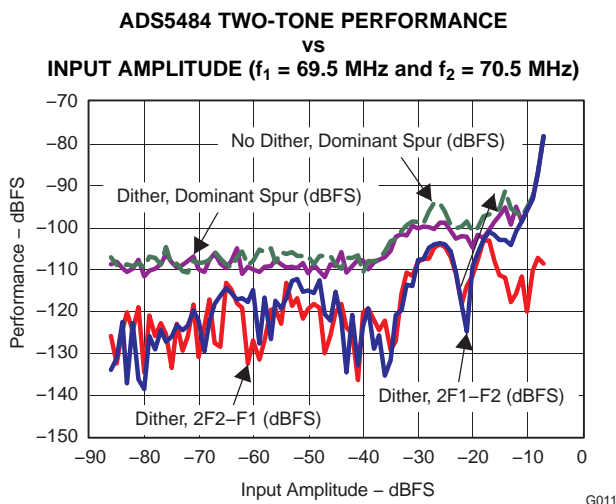

Figure 10.

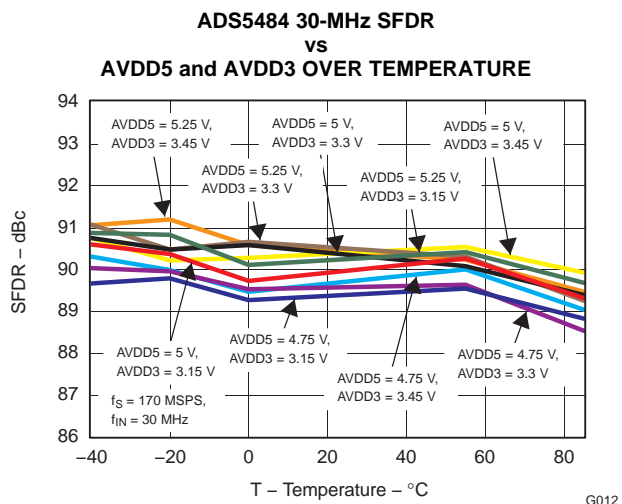

Figure 11.

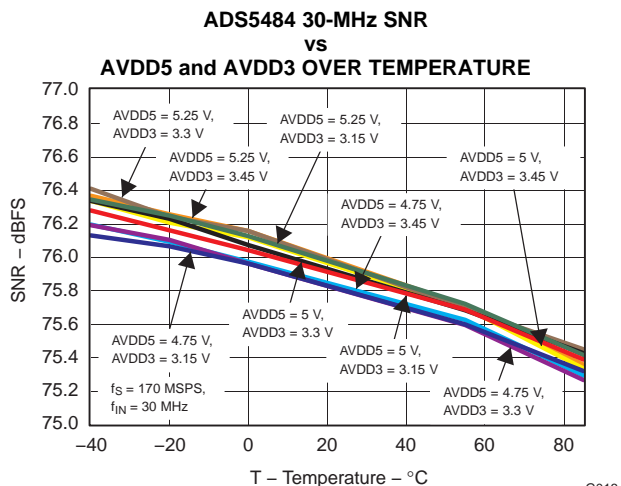

Figure 12.

TYPICAL CHARACTERISTICS (continued)

At $T_A = 25^\circ\text{C}$, sampling rate = max rated, 50% clock duty cycle, 3- V_{PP} differential sinusoidal clock, analog input amplitude = -1 dBFS, AVDD5 = 5 V, AVDD3 = 3.3 V, and DVDD3 = 3.3 V, unless otherwise noted.

ADS5485 - 200-MSPS Typical Data

Plots in this section are with a clock of 200 MSPS, unless otherwise specified.

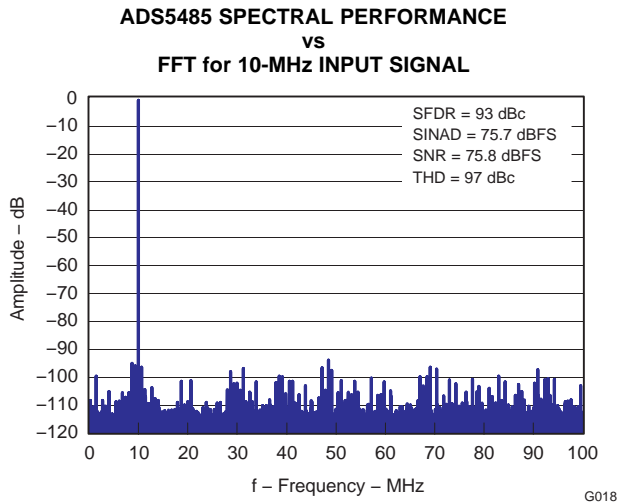

Figure 13.

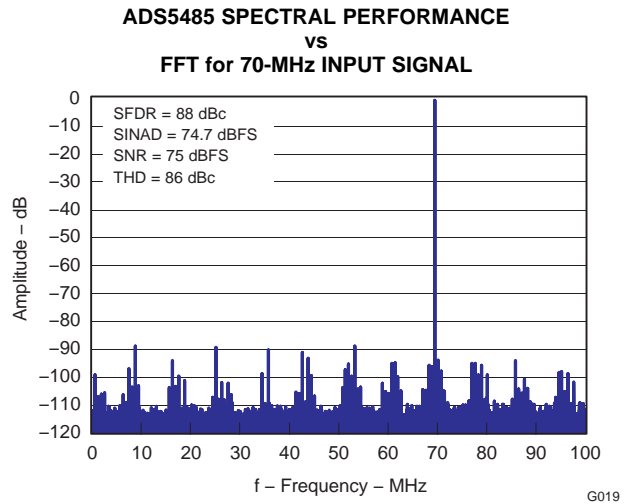

Figure 14.

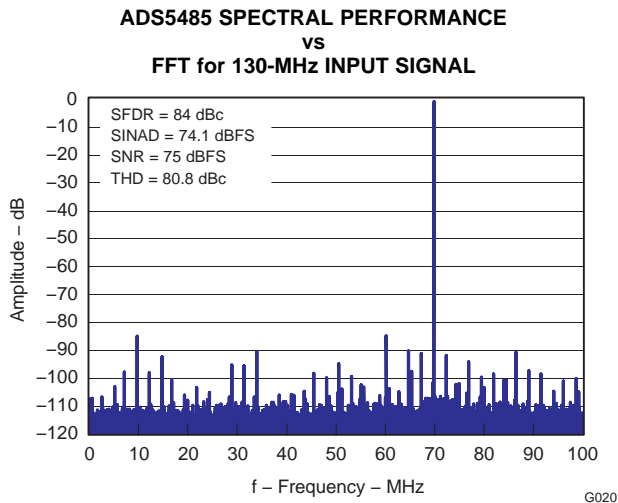

Figure 15.

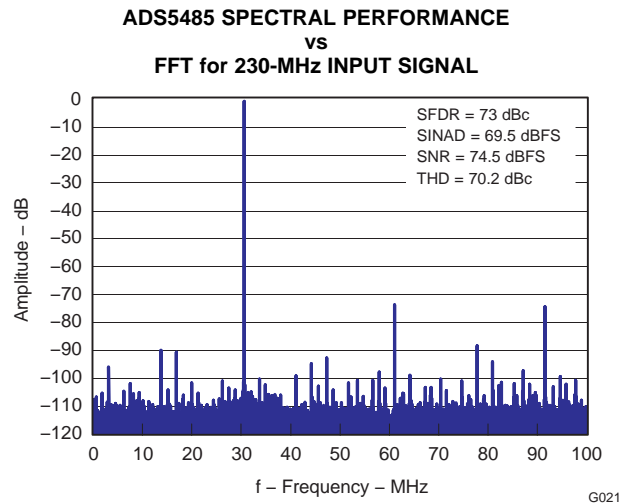

Figure 16.

TYPICAL CHARACTERISTICS (continued)

At $T_A = 25^\circ\text{C}$, sampling rate = max rated, 50% clock duty cycle, 3- V_{PP} differential sinusoidal clock, analog input amplitude = -1 dBFS, AVDD5 = 5 V, AVDD3 = 3.3 V, and DVDD3 = 3.3 V, unless otherwise noted.

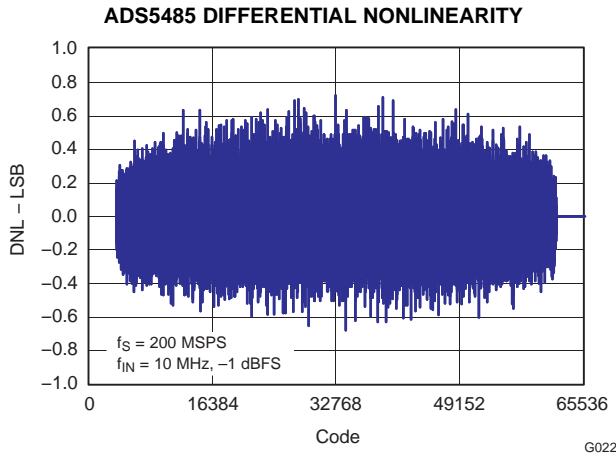

Figure 17.

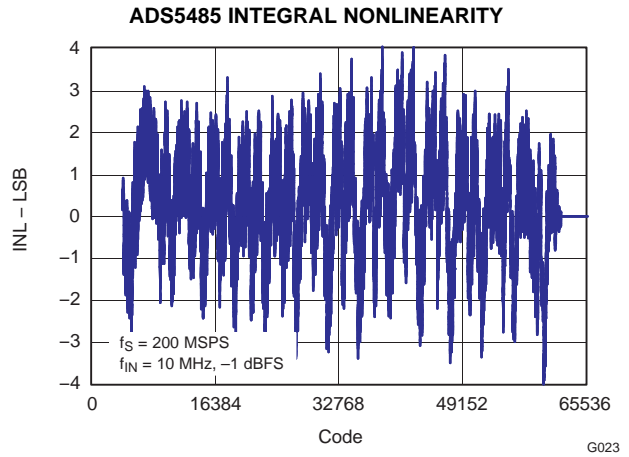

Figure 18.

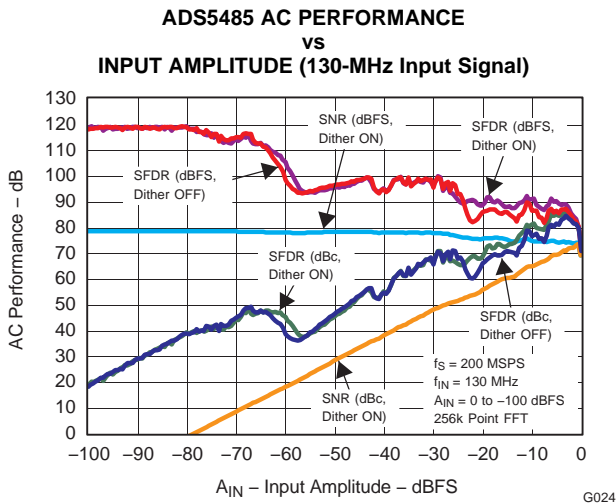

Figure 19.

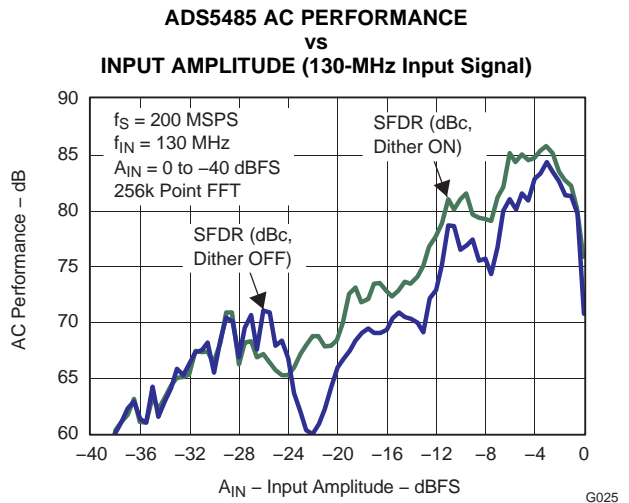

Figure 20.

TYPICAL CHARACTERISTICS (continued)

At $T_A = 25^\circ\text{C}$, sampling rate = max rated, 50% clock duty cycle, 3- V_{PP} differential sinusoidal clock, analog input amplitude = -1 dBFS, AVDD5 = 5 V, AVDD3 = 3.3 V, and DVDD3 = 3.3 V, unless otherwise noted.

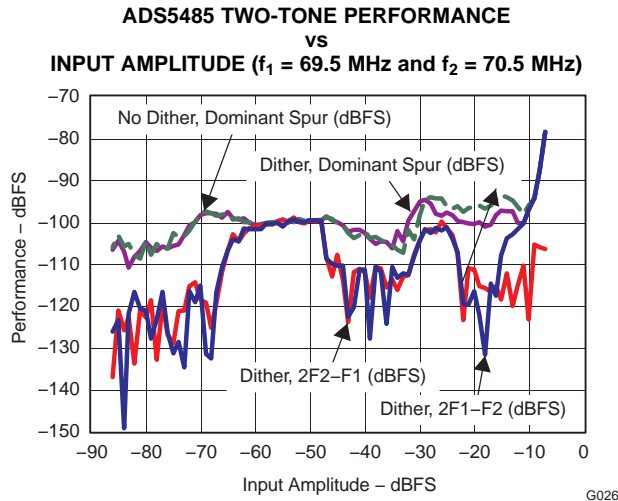

Figure 21.

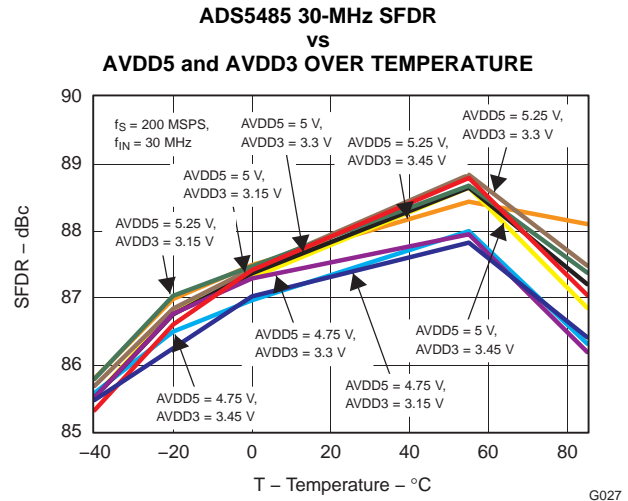

Figure 22.

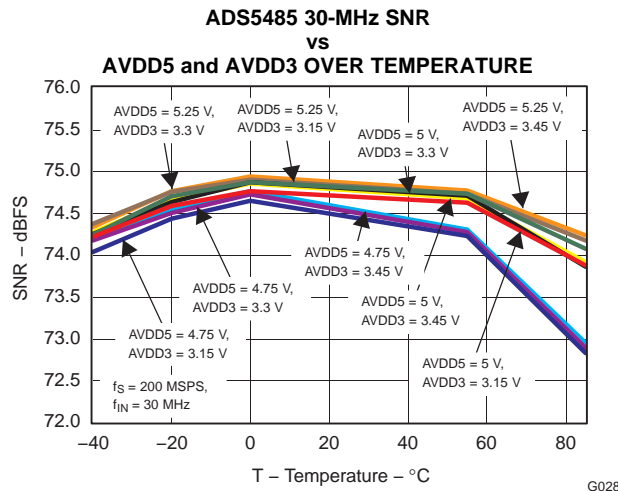

Figure 23.

TYPICAL CHARACTERISTICS (continued)

At $T_A = 25^\circ\text{C}$, sampling rate = max rated, 50% clock duty cycle, 3- V_{PP} differential sinusoidal clock, analog input amplitude = -1 dBFS, AVDD5 = 5 V, AVDD3 = 3.3 V, and DVDD3 = 3.3 V, unless otherwise noted.

Typical Data, Valid for Both ADS5484/5485

Plots in this section are valid for either device or otherwise have combined plots.

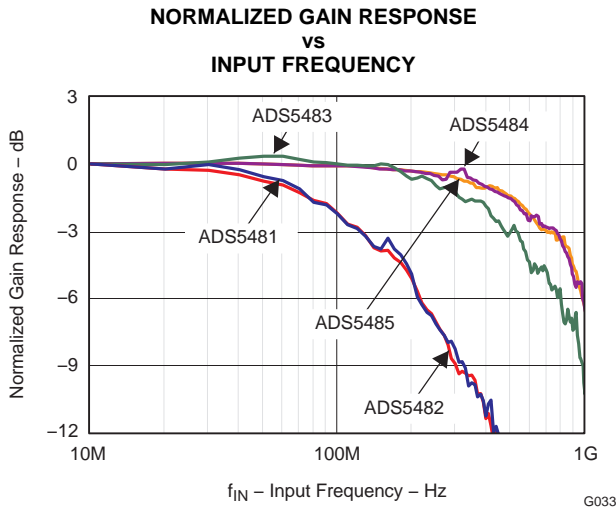

Figure 24.

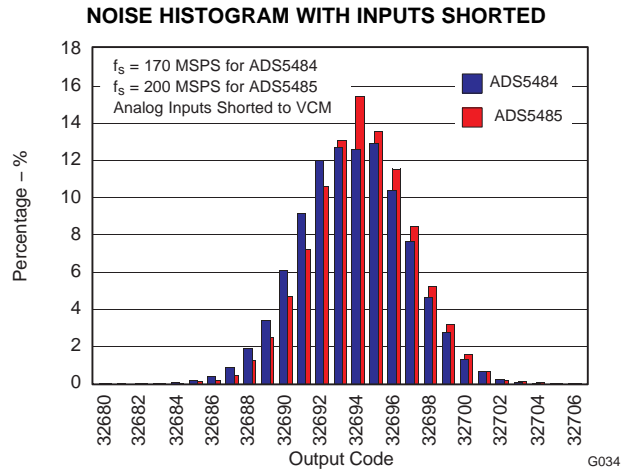

Figure 25.

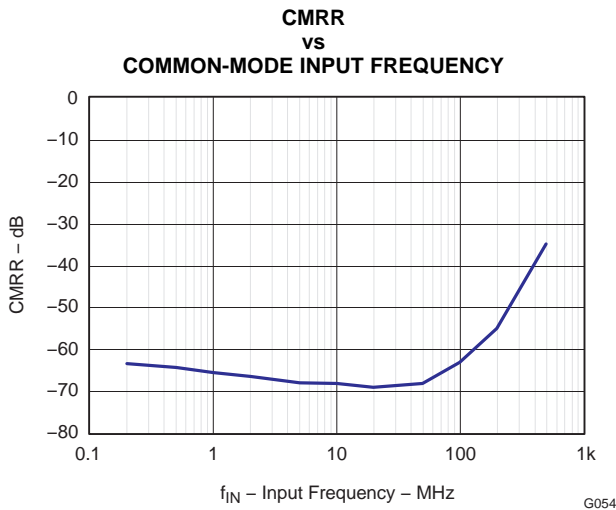

Figure 26.

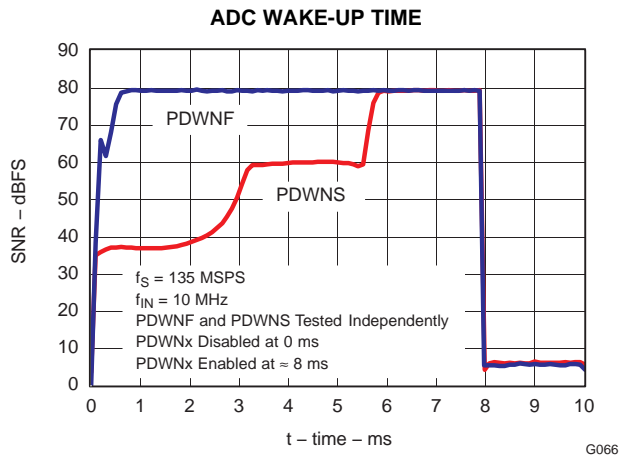

Figure 27.

TYPICAL CHARACTERISTICS (continued)

At $T_A = 25^\circ\text{C}$, sampling rate = max rated, 50% clock duty cycle, 3- V_{PP} differential sinusoidal clock, analog input amplitude = -1 dBFS, AVDD5 = 5 V, AVDD3 = 3.3 V, and DVDD3 = 3.3 V, unless otherwise noted.

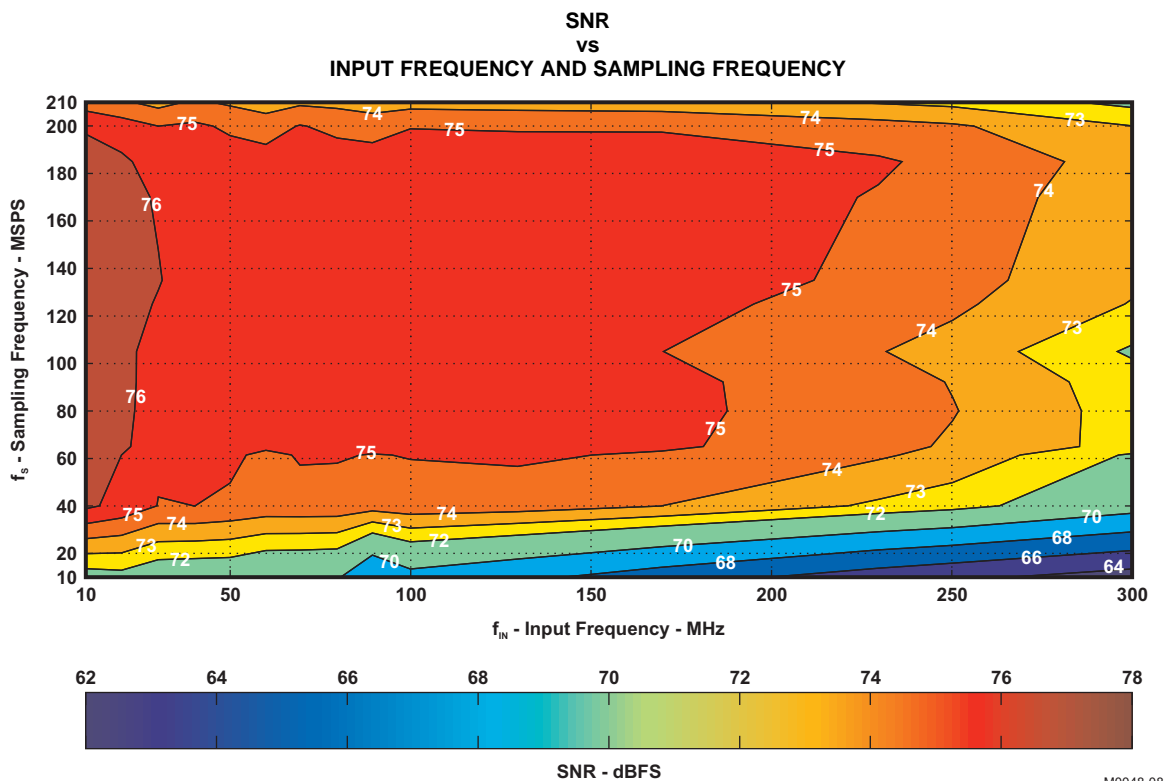

Figure 28.

[查询ADS5485 供应链](#)

TYPICAL CHARACTERISTICS (continued)

At $T_A = 25^\circ\text{C}$, sampling rate = max rated, 50% clock duty cycle, 3- V_{PP} differential sinusoidal clock, analog input amplitude = -1 dBFS, AVDD5 = 5 V, AVDD3 = 3.3 V, and DVDD3 = 3.3 V, unless otherwise noted.

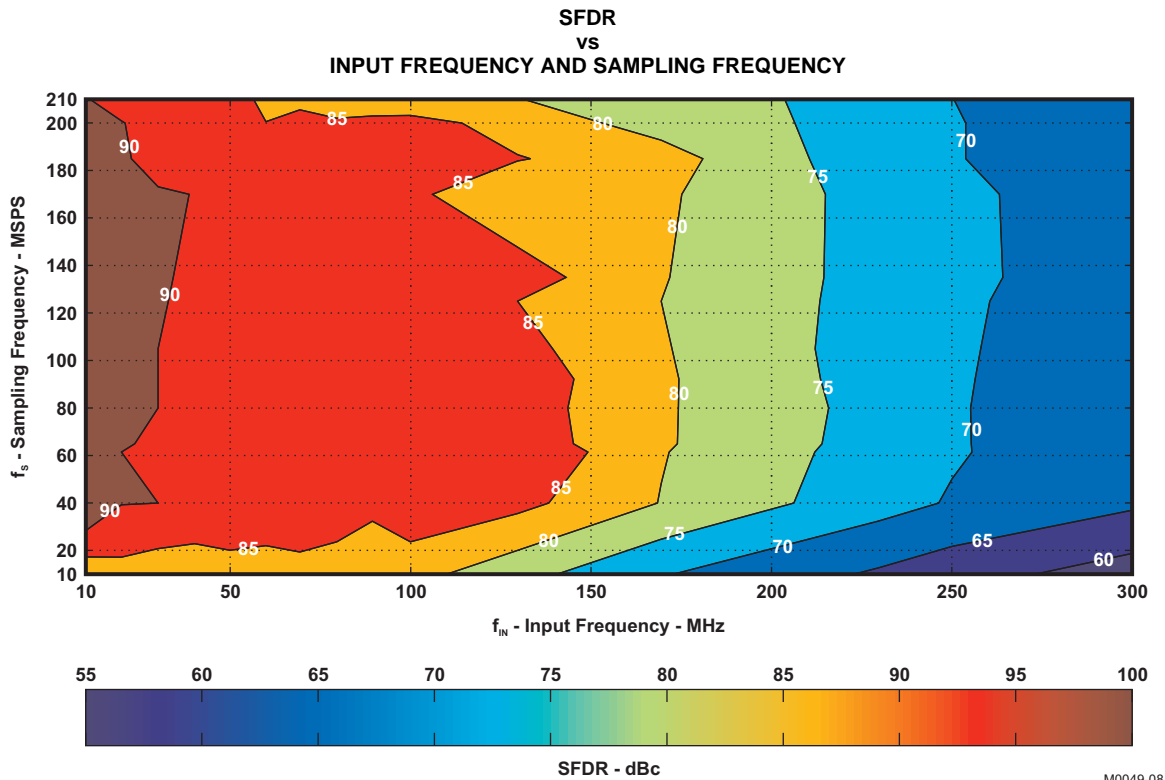

Figure 29.

APPLICATIONS INFORMATION

Theory of Operation

The ADS5484/ADS5485 (ADS548x) is a 16-bit, 170/200-MSPS family of monolithic pipeline ADCs. The bipolar analog core operates from 5-V and 3.3-V supplies, while the output uses a 3.3-V supply to provide LVDS-compatible outputs. Prior to the track-and-hold, the analog input signal passes through a high-performance bipolar buffer. The buffer presents a high and consistent impedance to the analog inputs. The buffer isolates the board circuitry external to the ADC from the sampling glitches caused by the track-and-hold in the ADC. The conversion process is initiated by the falling edge of the external input clock. At that instant, the differential input signal is captured by the input track-and-hold, and the input sample is converted sequentially by a series of lower resolution stages, with the outputs combined in a digital correction logic block. Both the rising and the falling clock edges are used to propagate the sample through the pipeline every half clock cycle. This process results in a data latency of 4.5 clock cycles, after which the output data are available as a 16-bit parallel word, coded in offset binary format.

Input Configuration

The analog input for the ADS548x consists of an analog pseudo-differential buffer followed by a bipolar transistor T & H. The analog buffer isolates the source driving the input of the ADC from any internal switching and presents a high impedance to drive at high input frequencies, as compared to an ADC without a buffered input. The input common-mode is set internally through a 1000- Ω resistor connected from 3.1 V to each of the inputs. This configuration results in a differential input impedance of 2 k Ω at 0 Hz. [Figure 30](#) estimates the package parasitics before soldering to a board. Each board is different, but soldering to the board will likely add 1 – 2 pF to the input capacitance.

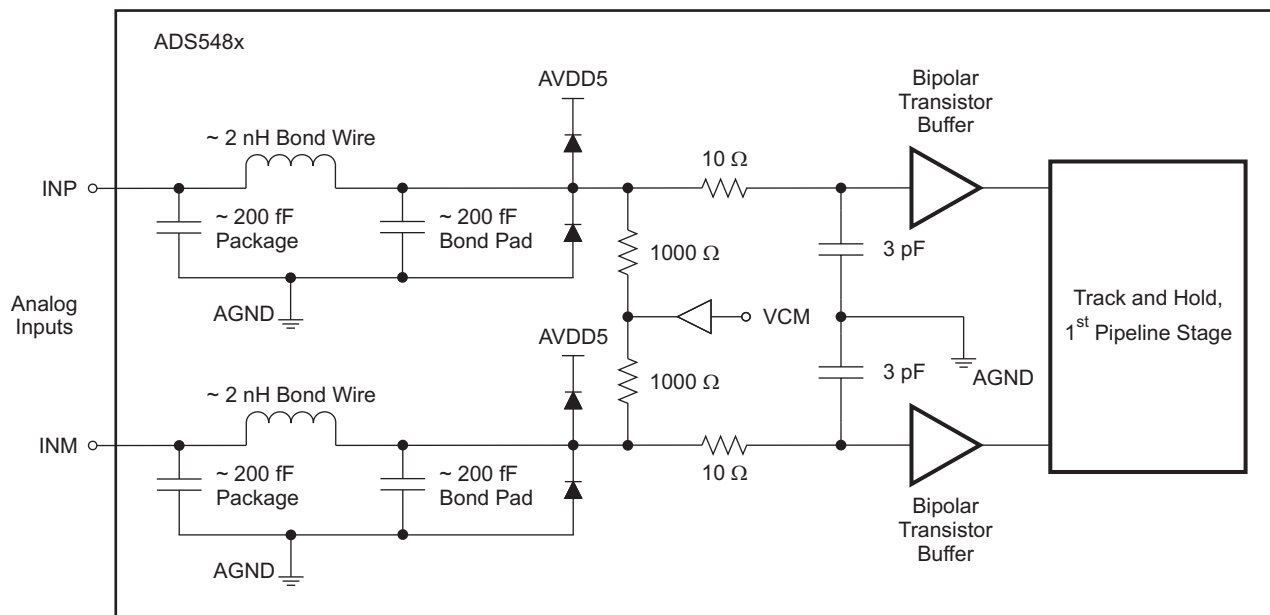

S0293-02

Figure 30. Analog Input Circuit (unsoldered package)

For a full-scale differential input, each of the differential lines of the input signal (pins 11 and 12) swings symmetrically between $(3.1\text{ V} + 0.75\text{ V})$ and $(3.1\text{ V} - 0.75\text{ V})$. This range means that each input has a maximum signal swing of 1.5 V_{PP} for a total differential input signal swing of 3 V_{PP} . Operation below 3 V_{PP} is allowable, with the characteristics of performance versus input amplitude demonstrated in [Figure 8](#) through [Figure 10](#). For instance, for performance at 2 V_{PP} rather than 3 V_{PP} , refer to the SNR and SFDR at -3.5 dBFS ($0\text{ dBFS} =$

3 V_{PP}). The maximum swing is determined by the internal reference voltage generator, eliminating the need for any external circuitry for this purpose. The primary degradation visible if the maximum amplitude is kept to 2 V_{PP} is ~3 dBc of SNR compared to using 3 V_{PP}, while SFDR is the same or even improved. The smaller input signal also possibly helps any components in the signal chain prior to the ADC to be more linear and provide better distortion.

The ADS548x performs optimally when the analog inputs are driven differentially. The circuit in Figure 31 shows one possible configuration using an RF transformer with termination either on the primary or on the secondary of the transformer. If voltage gain is required, a step-up transformer can be used.

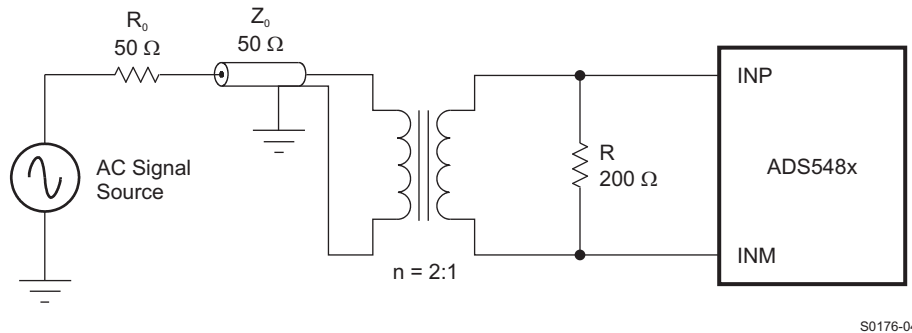

Figure 31. Converting a Single-Ended Input to a Differential Signal Using an RF Transformer

Dither

The ADS548x family of devices contain a dither option that is enabled via the DITHEREN pin. Dither is a technique applied to convert small static errors in the converter to dynamic errors, which look similar to white noise in the output. It improves the harmonics that are a function of the static errors. The dither is a low level and is only indicated in the output waveform as wideband noise that may slightly degrade the SNR. It is recommended that users should allow the capability to enable/disable it in the event they would like to compare the results during their evaluation. In addition to the plots on the first page of the data sheet, Figure 8 through Figure 10 and Figure 19 through Figure 21 show the minor differences of dither on/off when studied.

External Voltage Reference

For systems that require the analog signal gain to be adjusted or calibrated, this can be performed by using an external reference. The dependency on the signal amplitude to the value of the external reference voltage is characterized typically by Figure 32 (VREF = 1.2 V is normalized to 0 dB as this is the internal reference voltage). As can be seen in the linear fit, this equates to approximately ~1 dB of signal adjustment per 100 mV of reference adjustment. The range of allowable variation depends on the analog input amplitude that is applied to the inputs and the desired spectral performance, as can be seen in the performance versus external reference graphs in Figure 33 and Figure 34.

For dc-coupled applications that use the VCM pin of the ADS548x as the common mode of the signal in the analog signal gain path prior to the ADC inputs, Figure 36 indicates little change in VCM output as VREF is externally adjusted. The VCM output is buffered with a 2-kΩ series output resistor.

The method for disabling the internal reference for use with an external reference is described in Table 5. The following VREF adjustment graphs were collected using the ADS5483, but are indicative of the behavior of the ADS5484/5485. The absolute performance may differ from device to device, but the relative characteristics are valid.

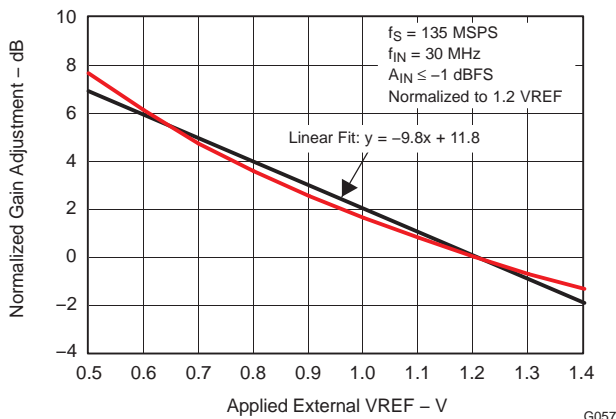

Figure 32. Signal Gain Adjustment versus External Reference (VREF)

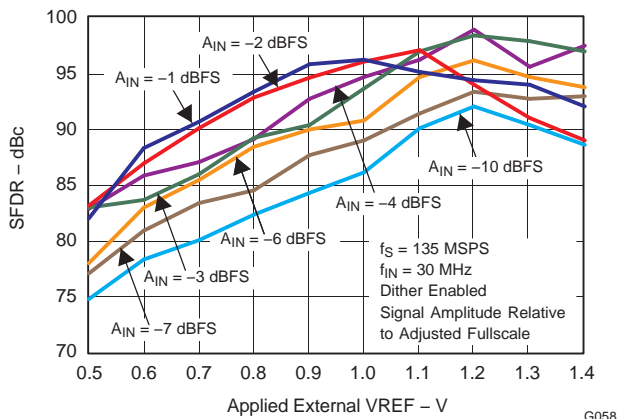

Figure 33. SFDR versus External VREF and A_{IN}

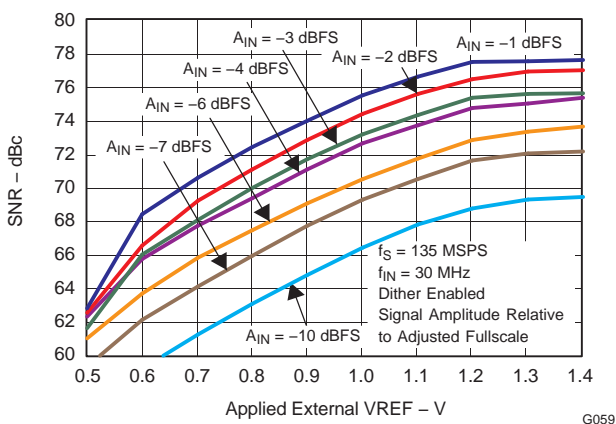

Figure 34. SNR versus External VREF and A_{IN}

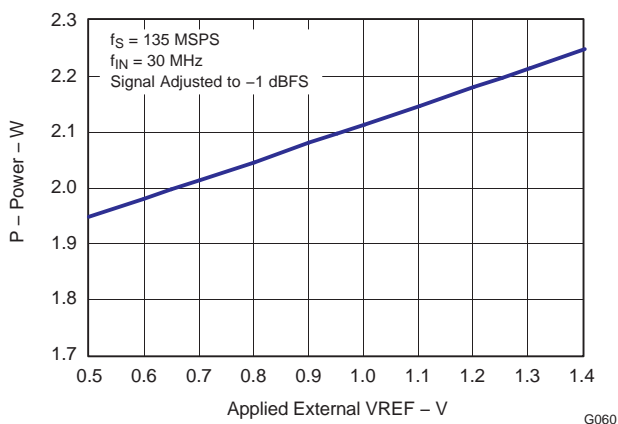

Figure 35. Total Power Consumption versus External VREF

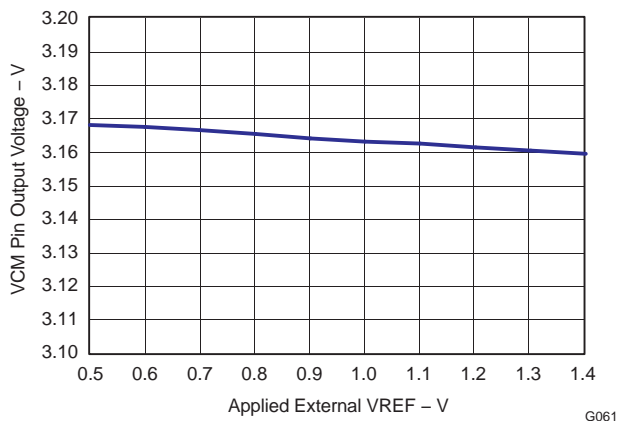
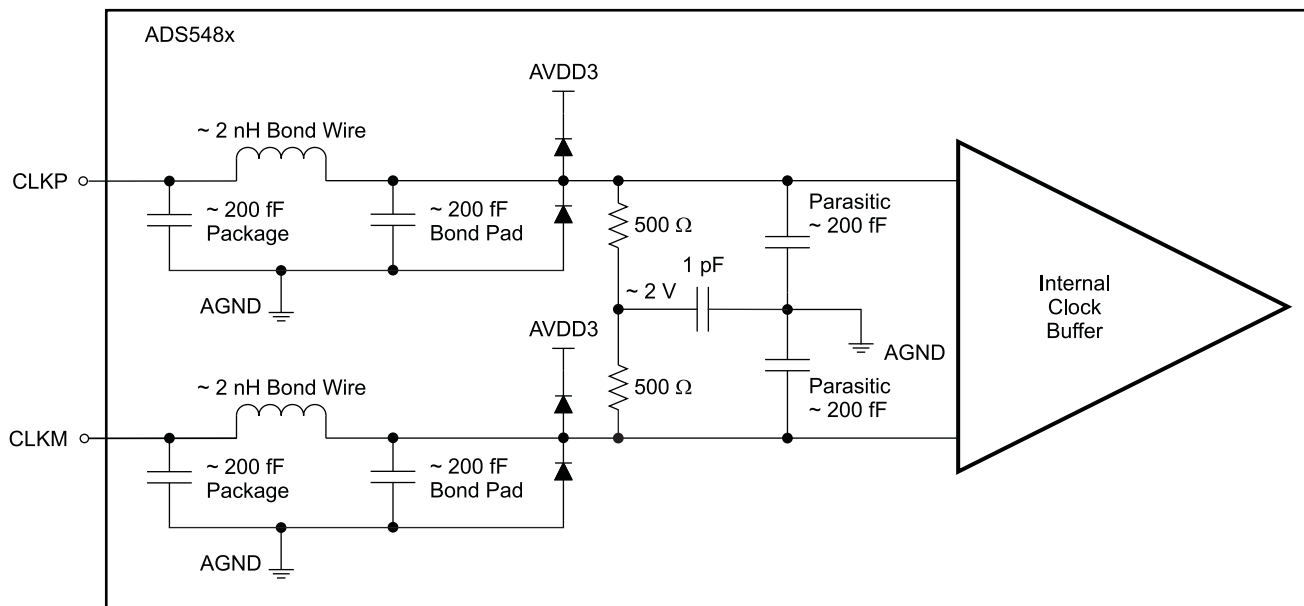

Figure 36. VCM Pin Output versus External VREF

[查询ADS5485 供应商](#)

Clock Inputs

The ADS548x equivalent clock input circuit is shown in Figure 37. The clock inputs can be driven with either a differential clock signal or a single-ended clock input, but differential is highly recommended. The characterization of the ADS548x is typically performed with a $3\text{-}V_{PP}$ differential clock, but the ADC performs well with a differential clock amplitude down to $\sim 1\text{ }V_{PP}$, as shown in Figure 39 and Figure 40. The performance is optimized when the clock amplitude is kept above $2\text{ }V_{PP}$. The clock amplitude becomes more of a factor in performance as the analog input frequency increases. When single-ended clocking is a necessity, it is best to connect CLKM to ground with a $0.01\text{-}\mu\text{F}$ capacitor, while CLKP is ac-coupled with a $0.01\text{-}\mu\text{F}$ capacitor to the clock source, as shown in Figure 38.



S0292-02

Figure 37. Clock Input Circuit

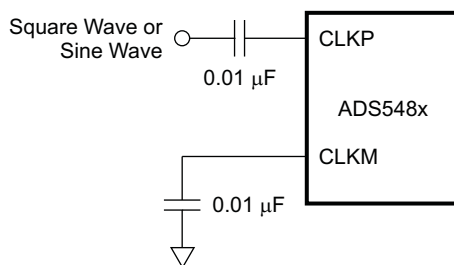

S0168-08

Figure 38. Single-Ended Clock

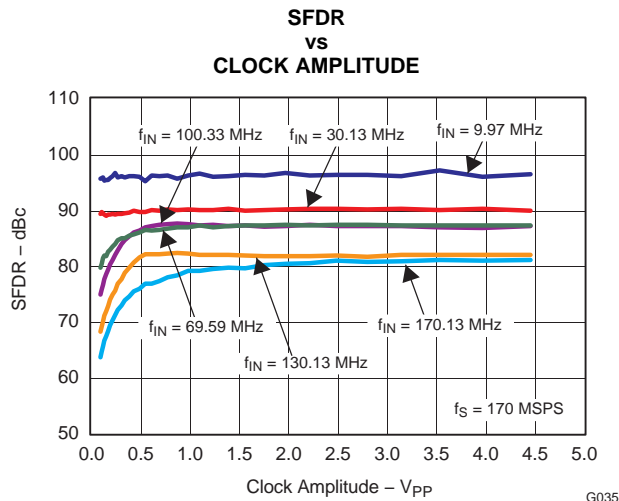

Figure 39.

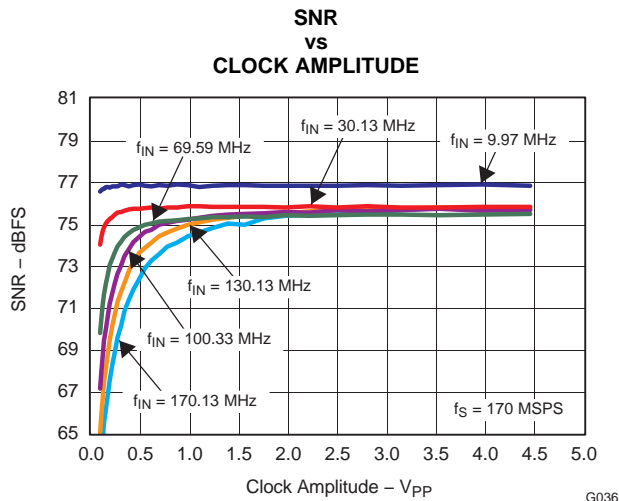

Figure 40.

For jitter-sensitive applications, the use of a differential clock has some advantages at the system level. The differential clock allows for common-mode noise rejection at the printed circuit board (PCB) level. With a differential clock, the signal-to-noise ratio of the ADC is better for jitter-sensitive, high-frequency applications because the board level clock jitter is superior.

The sampling process is more sensitive to jitter using high analog input frequencies or slow clock frequencies. Large clock amplitude levels are recommended when possible to reduce the indecision (jitter) in the ADC clock input buffer. Whenever possible, the ideal combination is a differential clock with large signal swing (~1 – 3 V_{PP}). Figure 41 demonstrates a recommended method for converting a single-ended clock source into a differential clock; it is similar to the configuration found on the evaluation board and was used for much of the characterization. See also *Clocking High Speed Data Converters (SLYT075)* for more details.

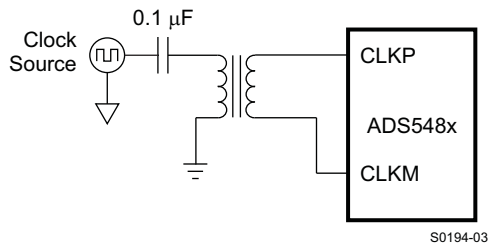

Figure 41. Differential Clock

The common-mode voltage of the clock inputs is set internally to ~2 V using internal 0.5-kΩ resistors. It is recommended to use ac coupling, but if this scheme is not possible, the ADS548x features good tolerance to clock common-mode variation (as shown in Figure 42 and Figure 43). The internal ADC core uses both edges of the clock for the conversion process. Ideally, a 50% duty-cycle clock signal should be provided. Performance degradation as a result of duty cycle can be seen in Figure 44.

[查询ADS5485 供应链](#)

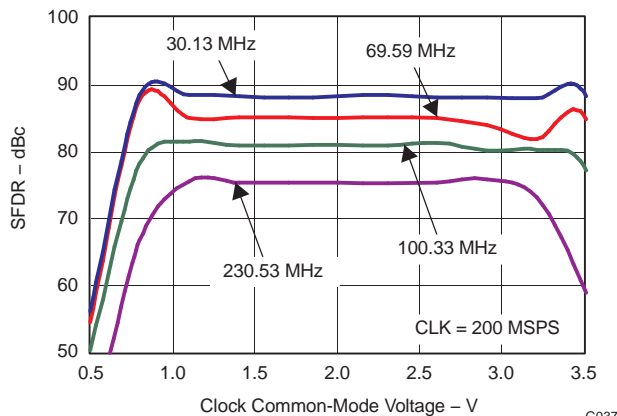

Figure 42. SFDR versus Clock Common-Mode Voltage

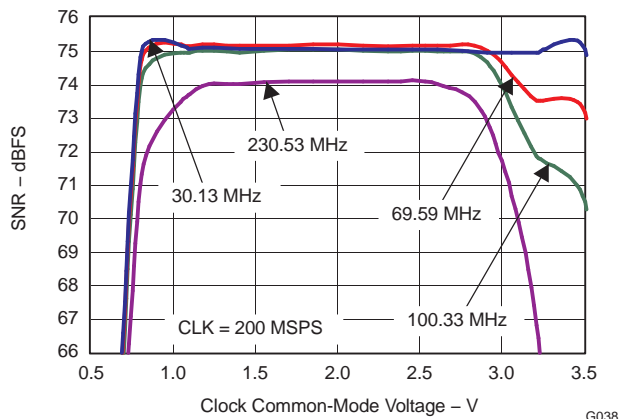

Figure 43. SNR versus Clock Common-Mode Voltage

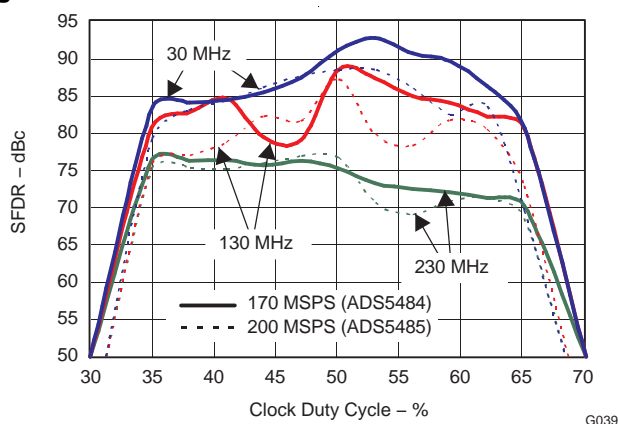

Figure 44. SFDR vs Clock Duty Cycle

The ADS5484 is capable of achieving 75.7 dBFS SNR at 130 MHz of analog input frequency. In order to achieve the SNR at 130 MHz the clock source rms jitter (at the ADC clock input pins) must be at most 184 fsec in order for the total rms jitter to be 201 fsec due to internal ADC aperture jitter of ~80 fsec. A summary of maximum recommended rms clock jitter as a function of analog input frequency for the ADS5484 is provided in [Table 3](#). The equations used to create the table are presented and can be used to estimate required clock jitter for virtually any pipeline ADC, but in particular, the ADS5481/5482/5483/5484/5485 family.

Table 3. Recommended Approximate RMS Clock Jitter for ADS5484

| ANALOG INPUT FREQUENCY (MHz) | MEASURED SNR (dBc) | TOTAL JITTER (fsec rms) | MAXIMUM CLOCK JITTER (fsec rms) |
|------------------------------|--------------------|-------------------------|---------------------------------|
| 10 | 76.8 | 2301 | 2299 |
| 30 | 75.9 | 851 | 847 |
| 70 | 75.7 | 373 | 364 |
| 130 | 75.7 | 201 | 184 |
| 170 | 75.6 | 155 | 133 |
| 230 | 74.9 | 124 | 95 |

Equation 1 and Equation 2 are used to estimate the required clock source jitter.

$$\text{SNR (dBc)} = -20 \times \text{LOG}_{10} (2 \times \pi \times f_{\text{IN}} \times j_{\text{TOTAL}}) \tag{1}$$

$$j_{\text{TOTAL}} = (j_{\text{ADC}}^2 + j_{\text{CLOCK}}^2)^{1/2} \tag{2}$$

where:

- j_{TOTAL} = the rms summation of the clock and ADC aperture jitter;
- j_{ADC} = the ADC internal aperture jitter which is located in the data sheet;
- j_{CLOCK} = the rms jitter of the clock at the clock input pins to the ADC; and
- f_{IN} = the analog input frequency.

Notice that the SNR is a strong function of the analog input frequency, not the clock frequency. The slope of the clock source edges can have a mild impact on SNR as well and is not taken into account for these estimates. For this reason, maximizing clock source amplitudes at the ADC clock inputs is recommended, though not required (faster slope is desirable for jitter-related SNR). For more information on clocking high-speed ADCs, see Application Note [SLWA034](#), *Implementing a CDC7005 Low Jitter Clock Solution For High-Speed, High-IF ADC Devices*, on the Texas Instruments web site. Recommended clock distribution chips (CDCs) are the TI [CDCE72010](#) and [CDCM7005](#). Depending on the jitter requirements, a band pass filter (BPF) is sometimes required between the CDC and the ADC. If the insertion loss of the BPF causes the clock amplitude to be too low for the ADC, or the clock source amplitude is too low to begin with, an inexpensive amplifier can be placed between the CDC and the BPF, as its harmonics and wide-band noise are reduced by the BPF.

Figure 45 represents a scenario where an LVCMOS single-ended clock output is used from a TI CDCE72010 with the clock signal path optimized for maximum amplitude and minimum jitter. The jitter of this setup is difficult to estimate and requires a careful phase noise analysis of the clock path. The BPF (and possibly a low-cost amplifier because of insertion loss in the BPF) can improve the jitter between the CDC and ADC when the jitter provided by the CDC is still not adequate. The total jitter at the CDCE72010 output depends largely on the phase noise of the VCXO/VCO selected, as well as from the CDCE72010 itself.

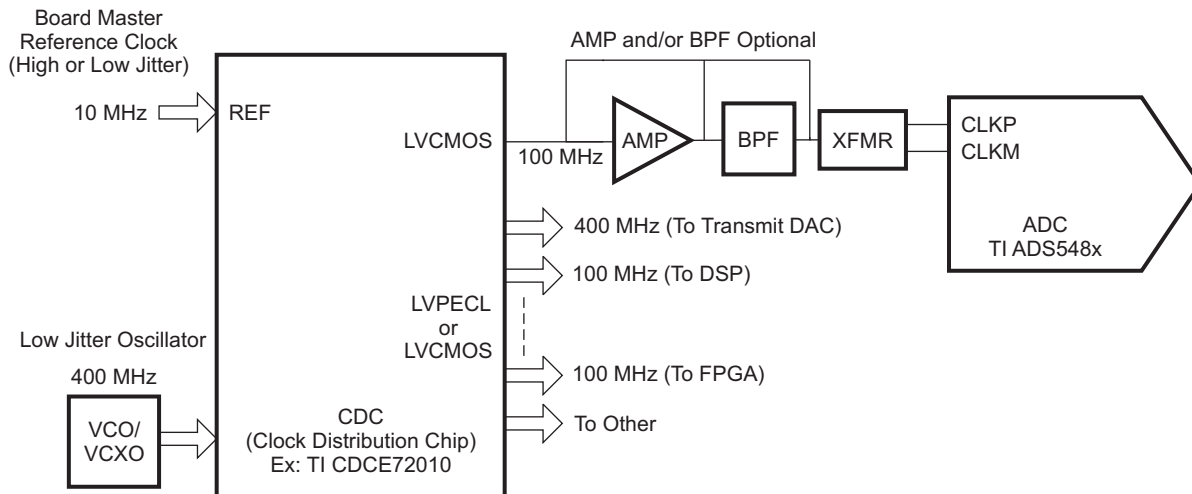

B0268-01

Consult the [CDCE72010 data sheet](#) for proper schematic and specifications regarding allowable input and output frequency and amplitude ranges.

Figure 45. Optimum Jitter Clock Circuit

Digital Outputs

The ADC provides eight LVDS-compatible, offset binary, DDR data outputs (2 bits per LVDS output driver) and a data-ready LVDS signal (DRY). It is recommended to use the DRY signal to capture the output data of the ADS548x (use as a clock output). DRY is source-synchronous to the DATA outputs and operates at the same frequency, creating a full-rate DDR interface that updates data on both the rising and falling edges of DRY. It is recommended that the capacitive loading on the digital outputs be minimized. Higher capacitance shortens the data-valid timing window. The values given for timing (see [Figure 1](#)) were obtained with a 5-pF parasitic board capacitance to ground on each LVDS line. When setting the time relationship between DRY and DATA at the receiving device, it is generally recommended that setup time be maximized, but this partially depends on the setup and hold times of the device receiving the digital data. Since DRY and DATA are coincident, it will likely be necessary to delay either DRY such that DATA setup time is maximized.

The LVDS outputs all require an external 100-Ω load between each output pair in order to meet the expected LVDS voltage levels. For long trace lengths, it may be necessary to place a 100-Ω load on each digital output as close to the ADS548x as possible and another 100-Ω differential load at the end of the LVDS transmission line to terminate the transmission line and avoid signal reflections. The effective load in this case reduces the LVDS voltage levels by half. The current of all LVDS drivers is set externally with a resistor connected between the LVDSB (LVDS bias) pin and ground. Normal LVDS current is 3.5 mA per LVDS pair, set with a 10-kΩ external resistor. For systems with excessive load capacitance on the LVDS lines, reducing the resistor value in order to increase the LVDS bias current is allowed to create a stronger LVDS drive capability. For systems with short traces and minimal loading, increasing the resistor in order to decrease the LVDS current is allowable in order to save power. [Table 4](#) provides a sampling of LVDSB resistor values should deviation from the recommended LVDS output current of 3.5 mA be considered. It is not recommended to exceed the range listed in the table. If the LVDS bias current is adjusted, the differential load resistance should also be adjusted to maintain voltage levels within the specification for the LVDS outputs. The signal integrity of the LVDS lines on the board layout should be scrutinized to ensure proper LVDS signal integrity exists.

Table 4. Setting the LVDS Current Drive

| LVDSB RESISTOR TO GND, Ω | LVDS NOMINAL CURRENT, mA |
|---|--------------------------|
| 6k | 5.6 |
| 8k | 4.3 |
| 10k (value for normal recommended operation) | 3.5 |
| 12k | 2.8 |
| 14k | 2.3 |
| 16k | 2.0 |
| 18k | 1.7 |
| 20k | 1.5 |

Power Supplies and Sleep Modes

The ADS548x uses three power supplies. For the analog portion of the design, a 5-V and 3.3-V supply (AVDD5 and AVDD3) are used, while the digital portion uses a 3.3-V supply (DVDD3). The use of low-noise power supplies with adequate decoupling is recommended. Linear supplies are preferred to switched supplies; switched supplies generate more noise that can be coupled to the ADS548x. However, the PSRR value and plot shown in Figure 46 were obtained without bulk supply decoupling capacitors. When bulk (0.1- μ F) decoupling capacitors are used near the supply pins, the board-level PSRR is much higher than the stated value for the ADC. The user may be able to supply power to the device with a less-than-ideal supply and still achieve good performance. It is not possible to make a single recommendation for every type of supply and level of decoupling for all systems. If the noise characteristics of the available supplies are understood, a study of the PSRR data for the ADS548x may provide the user with enough information to select noisy supplies if the performance is still acceptable within the frequency range of interest. The power consumption of the ADS548x does not change substantially over clock rate or input frequency.

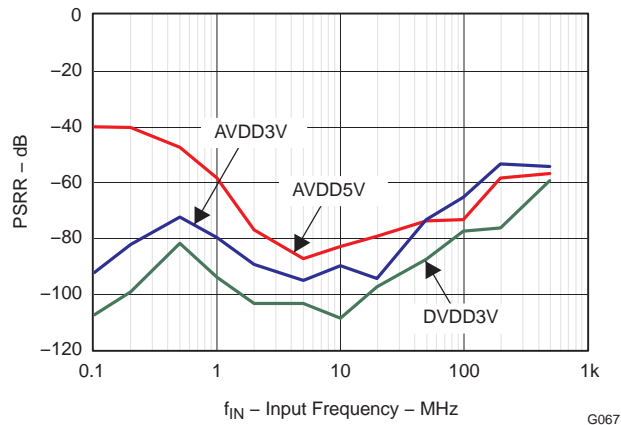

Figure 46. PSRR versus Supply Injected Frequency

Two separate sleep modes are offered. They are differentiated by the amount of power consumed and the time it takes for the ADC to wake-up from sleep. The light sleep mode consumes 605 mW and can be used when wake-up of less than 600 μ s is required. Deep sleep consumes 70 mW and requires 6 ms to wake-up. See the wake-up characteristic in Figure 27. For directions on enabling these modes, see Table 5. The input clock can be in either state when the power-down modes are enabled. The device can enter power-down mode whether using an internal or external reference. However, the wake-up time from light sleep enabled to external reference mode is dependent on the external reference voltage and is not necessarily 0.6 ms, but should be noticeably faster than deep sleep wake-up. No specific power sequences are required.

Table 5. Power-Down and Reference Modes

| MODE | PDWNF PIN | PDWNS PIN | POWER CONSUMPTION | WAKE-UP TIME |
|-----------------------------|-----------|-----------|---------------------|--------------|
| ADC On - Internal reference | Low | Low | 2.16 W | On |
| ADC On - External reference | High | High | 2.16 W | On |
| Light sleep | High | Low | 600 mW when enabled | 0.6 ms |
| Deep sleep | Low | High | 70 mW when enabled | 6 ms |

Layout Information

The evaluation board represents a good model of how to lay out the printed circuit board (PCB) to obtain the maximum performance from the ADS548x. Follow general design rules, such as the use of multilayer boards, a single ground plane for ADC ground connections, and local decoupling ceramic chip capacitors. The analog input traces should be isolated from any external source of interference or noise, including the digital outputs as well as the clock traces. The clock signal traces should also be isolated from other signals, especially in applications such as high IF sampling where low jitter is required. Besides performance-oriented rules, care must be taken when considering the heat dissipation of the device. The thermal heat sink included on the bottom of the package should be soldered to the board as described in the [PowerPad Package](#) section. See the *ADS548x EVM User Guide* on the [TI web site](#) for the evaluation board schematic.

PowerPAD Package

The PowerPAD package is a thermally-enhanced, standard-size IC package designed to eliminate the use of bulky heat sink and slugs traditionally used in thermal packages. This package can be easily mounted using standard PCB assembly techniques and can be removed and replaced using standard repair procedures.

The PowerPAD package is designed so that the leadframe die pad (or thermal pad) is exposed on the bottom of the IC. This pad design provides an extremely low thermal resistance path between the die and the exterior of the package. The thermal pad on the bottom of the IC can then be soldered directly to the PCB, using the PCB as a heat sink.

Assembly Process

1. Prepare the PCB top-side etch pattern including etch for the leads as well as the thermal pad as illustrated in the Mechanical Data section (at the end of this data sheet).
2. Place a 6-by-6 array of thermal vias in the thermal pad area. These holes should be 13 mils (0.013 in or 0.3302 mm) in diameter. The small size prevents wicking of the solder through the holes.
3. It is recommended to place a small number of 25 mil (0.025 in or 0.635 mm) diameter holes under the package, but outside the thermal pad area, to provide an additional heat path.
4. Connect all holes (both those inside and outside the thermal pad area) to an internal copper plane (such as a ground plane).
5. Do not use the typical web or spoke via-connection pattern when connecting the thermal vias to the ground plane. The spoke pattern increases the thermal resistance to the ground plane.
6. The top-side solder mask should leave exposed the terminals of the package and the thermal pad area.
7. Cover the entire bottom side of the PowerPAD vias to prevent solder wicking.
8. Apply solder paste to the exposed thermal pad area and all of the package terminals.

For more detailed information regarding the PowerPAD package and its thermal properties, see either the *PowerPAD Made Easy* application brief ([SLMA004](#)) or the *PowerPAD Thermally Enhanced Package* application report ([SLMA002](#)), both available for download at [www.ti.com](#).

DEFINITION OF SPECIFICATIONS

Analog Bandwidth

The analog input frequency at which the power of the fundamental is reduced by 3 dB with respect to the low-frequency value.

Aperture Delay

The delay in time between the rising edge of the input sampling clock and the actual time at which the sampling occurs.

Aperture Uncertainty (Jitter)

The sample-to-sample variation in aperture delay.

Clock Pulse Duration/Duty Cycle

The duty cycle of a clock signal is the ratio of the time the clock signal remains at a logic high (clock pulse duration) to the period of the clock signal, expressed as a percentage.

Differential Nonlinearity (DNL)

An ideal ADC exhibits code transitions at analog input values spaced exactly 1 LSB apart. DNL is the deviation of any single step from this ideal value, measured in units of LSB.

Common-Mode Rejection Ratio (CMRR)

CMRR measures the ability to reject signals that are presented to both analog inputs simultaneously. The injected common-mode frequency level is translated into dBFS, the spur in the output FFT is measured in dBFS, and the difference is the CMRR in dB.

Effective Number of Bits (ENOB)

ENOB is a measure in units of bits of converter performance as compared to the theoretical limit based on quantization noise:

$$\text{ENOB} = (\text{SINAD} - 1.76)/6.02$$

Gain Error

Gain error is the deviation of the ADC actual input full-scale range from its ideal value, given as a percentage of the ideal input full-scale range.

Integral Nonlinearity (INL)

INL is the deviation of the ADC transfer function from a best-fit line determined by a least-squares curve fit of that transfer function. The INL at each analog input value is the difference between the actual transfer function and this best-fit line, measured in units of LSB.

Offset Error

Offset error is the deviation of output code from mid-code when both inputs are tied to common-mode.

Power-Supply Rejection Ratio (PSRR)

PSRR is a measure of the ability to reject frequencies present on the power supply.

The injected frequency level is translated into dBFS, the spur in the output FFT is measured in dBFS, and the difference is the PSRR in dB. The measurement calibrates out the benefit of the board supply decoupling capacitors.

Signal-to-Noise Ratio (SNR)

SNR is the ratio of the power of the fundamental (P_S) to the noise floor power (P_N), excluding the power at dc and in the first five harmonics.

$$\text{SNR} = 10\log_{10} \frac{P_S}{P_N} \quad (4)$$

SNR is either given in units of dBc (dB to carrier) when the absolute power of the fundamental is used as the reference, or dBFS (dB to full-scale) when the power of the fundamental is extrapolated to the converter full-scale range.

Signal-to-Noise and Distortion (SINAD)

SINAD is the ratio of the power of the fundamental (P_S) to the power of all the other spectral components including noise (P_N) and distortion (P_D), but excluding dc.

$$\text{SINAD} = 10\log_{10} \frac{P_S}{P_N + P_D} \quad (5)$$

SINAD is either given in units of dBc (dB to carrier) when the absolute power of the fundamental is used as the reference, or dBFS (dB to full-scale) when the power of the fundamental is extrapolated to the converter full-scale range.

Temperature Drift

Temperature drift (with respect to gain error and offset error) specifies the change from the value at the nominal temperature to the value at T_{MIN} or T_{MAX} . It is computed as the maximum variation the parameters over the whole temperature range divided by $T_{\text{MIN}} - T_{\text{MAX}}$.

Total Harmonic Distortion (THD)

THD is the ratio of the power of the fundamental (P_S) to the power of the first five harmonics (P_D).

$$\text{THD} = 10\log_{10} \frac{P_S}{P_D} \quad (6)$$

THD is typically given in units of dBc (dB to carrier).

Two-Tone Intermodulation Distortion (IMD3)

IMD3 is the ratio of the power of the fundamental (at frequencies f_1 , f_2) to the power of the worst spectral component at either frequency $2f_1 - f_2$ or $2f_2 - f_1$. IMD3 is given in units of either dBc (dB to carrier) when the absolute power of the fundamental is used as the reference, or dBFS (dB to full-scale) when the power of the fundamental is extrapolated to the converter full-scale range.

[查询ADS5485 供应商](#)

REVISION HISTORY

| Changes from Revision B (July 2009) to Revision C | Page |
|---|------|
| • Changed pin PDWNF from 35 to 34 | 9 |
| • Changed pin PDWNS from 34 to 35 | 9 |

PACKAGING INFORMATION

| Orderable Device | Status ⁽¹⁾ | Package Type | Package Drawing | Pins | Package Qty | Eco Plan ⁽²⁾ | Lead/Ball Finish | MSL Peak Temp ⁽³⁾ |
|------------------|-----------------------|--------------|-----------------|------|-------------|-------------------------|------------------|------------------------------|
| ADS5484IRGC25 | ACTIVE | VQFN | RGC | 64 | 25 | Green (RoHS & no Sb/Br) | CU NIPDAU | Level-3-260C-168 HR |
| ADS5484IRGCR | ACTIVE | VQFN | RGC | 64 | 2000 | Green (RoHS & no Sb/Br) | CU NIPDAU | Level-3-260C-168 HR |
| ADS5484IRGCRG4 | ACTIVE | VQFN | RGC | 64 | 2000 | Green (RoHS & no Sb/Br) | CU NIPDAU | Level-3-260C-168 HR |
| ADS5484IRGCT | ACTIVE | VQFN | RGC | 64 | 250 | Green (RoHS & no Sb/Br) | CU NIPDAU | Level-3-260C-168 HR |
| ADS5484IRGCTG4 | ACTIVE | VQFN | RGC | 64 | 250 | Green (RoHS & no Sb/Br) | CU NIPDAU | Level-3-260C-168 HR |
| ADS5485IRGC25 | ACTIVE | VQFN | RGC | 64 | 25 | Green (RoHS & no Sb/Br) | CU NIPDAU | Level-3-260C-168 HR |
| ADS5485IRGCR | ACTIVE | VQFN | RGC | 64 | 2000 | Green (RoHS & no Sb/Br) | CU NIPDAU | Level-3-260C-168 HR |
| ADS5485IRGCRG4 | ACTIVE | VQFN | RGC | 64 | 2000 | Green (RoHS & no Sb/Br) | CU NIPDAU | Level-3-260C-168 HR |
| ADS5485IRGCT | ACTIVE | VQFN | RGC | 64 | 250 | Green (RoHS & no Sb/Br) | CU NIPDAU | Level-3-260C-168 HR |
| ADS5485IRGCTG4 | ACTIVE | VQFN | RGC | 64 | 250 | Green (RoHS & no Sb/Br) | CU NIPDAU | Level-3-260C-168 HR |

⁽¹⁾ The marketing status values are defined as follows:

ACTIVE: Product device recommended for new designs.

LIFEBUY: TI has announced that the device will be discontinued, and a lifetime-buy period is in effect.

NRND: Not recommended for new designs. Device is in production to support existing customers, but TI does not recommend using this part in a new design.

PREVIEW: Device has been announced but is not in production. Samples may or may not be available.

OBsolete: TI has discontinued the production of the device.

⁽²⁾ Eco Plan - The planned eco-friendly classification: Pb-Free (RoHS), Pb-Free (RoHS Exempt), or Green (RoHS & no Sb/Br) - please check <http://www.ti.com/productcontent> for the latest availability information and additional product content details.

TBD: The Pb-Free/Green conversion plan has not been defined.

Pb-Free (RoHS): TI's terms "Lead-Free" or "Pb-Free" mean semiconductor products that are compatible with the current RoHS requirements for all 6 substances, including the requirement that lead not exceed 0.1% by weight in homogeneous materials. Where designed to be soldered at high temperatures, TI Pb-Free products are suitable for use in specified lead-free processes.

Pb-Free (RoHS Exempt): This component has a RoHS exemption for either 1) lead-based flip-chip solder bumps used between the die and package, or 2) lead-based die adhesive used between the die and leadframe. The component is otherwise considered Pb-Free (RoHS compatible) as defined above.

Green (RoHS & no Sb/Br): TI defines "Green" to mean Pb-Free (RoHS compatible), and free of Bromine (Br) and Antimony (Sb) based flame retardants (Br or Sb do not exceed 0.1% by weight in homogeneous material)

⁽³⁾ MSL, Peak Temp. -- The Moisture Sensitivity Level rating according to the JEDEC industry standard classifications, and peak solder temperature.

Important Information and Disclaimer: The information provided on this page represents TI's knowledge and belief as of the date that it is provided. TI bases its knowledge and belief on information provided by third parties, and makes no representation or warranty as to the accuracy of such information. Efforts are underway to better integrate information from third parties. TI has taken and continues to take reasonable steps to provide representative and accurate information but may not have conducted destructive testing or chemical analysis on incoming materials and chemicals. TI and TI suppliers consider certain information to be proprietary, and thus CAS numbers and other limited information may not be available for release.

In no event shall TI's liability arising out of such information exceed the total purchase price of the TI part(s) at issue in this document sold by TI to Customer on an annual basis.

TAPE AND REEL INFORMATION

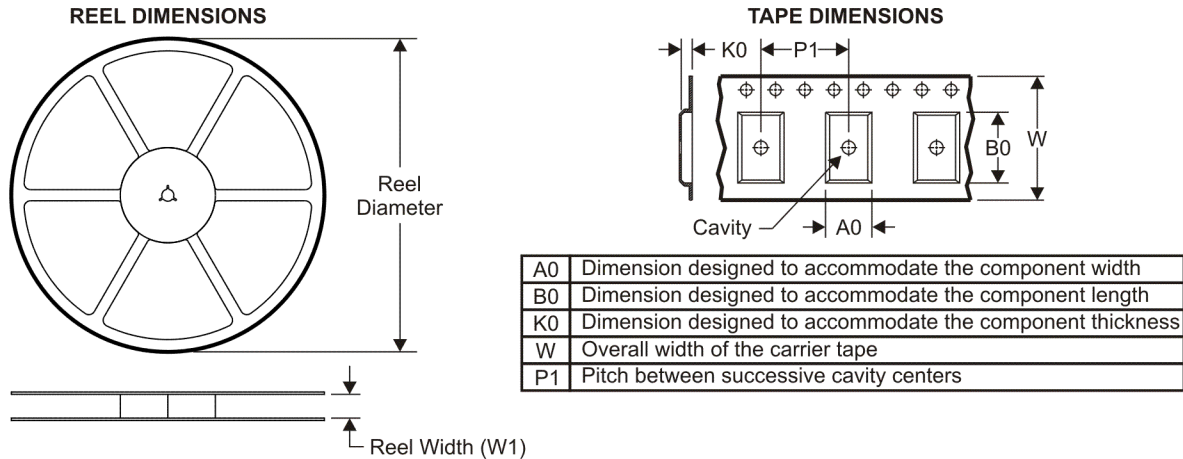

QUADRANT ASSIGNMENTS FOR PIN 1 ORIENTATION IN TAPE

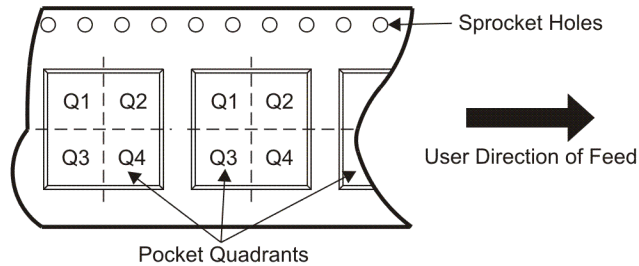

*All dimensions are nominal

| Device | Package Type | Package Drawing | Pins | SPQ | Reel Diameter (mm) | Reel Width W1 (mm) | A0 (mm) | B0 (mm) | K0 (mm) | P1 (mm) | W (mm) | Pin1 Quadrant |
|--------------|--------------|-----------------|------|------|--------------------|--------------------|---------|---------|---------|---------|--------|---------------|
| ADS5485IRGCR | VQFN | RGC | 64 | 2000 | 330.0 | 16.4 | 9.3 | 9.3 | 1.5 | 12.0 | 16.0 | Q2 |

TAPE AND REEL BOX DIMENSIONS



*All dimensions are nominal

| Device | Package Type | Package Drawing | Pins | SPQ | Length (mm) | Width (mm) | Height (mm) |
|--------------|--------------|-----------------|------|------|-------------|------------|-------------|
| ADS5485IRGCR | VQFN | RGC | 64 | 2000 | 333.2 | 345.9 | 28.6 |

RGC(S-PVQFN-N64) CUSTOM DEVICE PLASTIC QUAD FLATPACK NO-LEAD

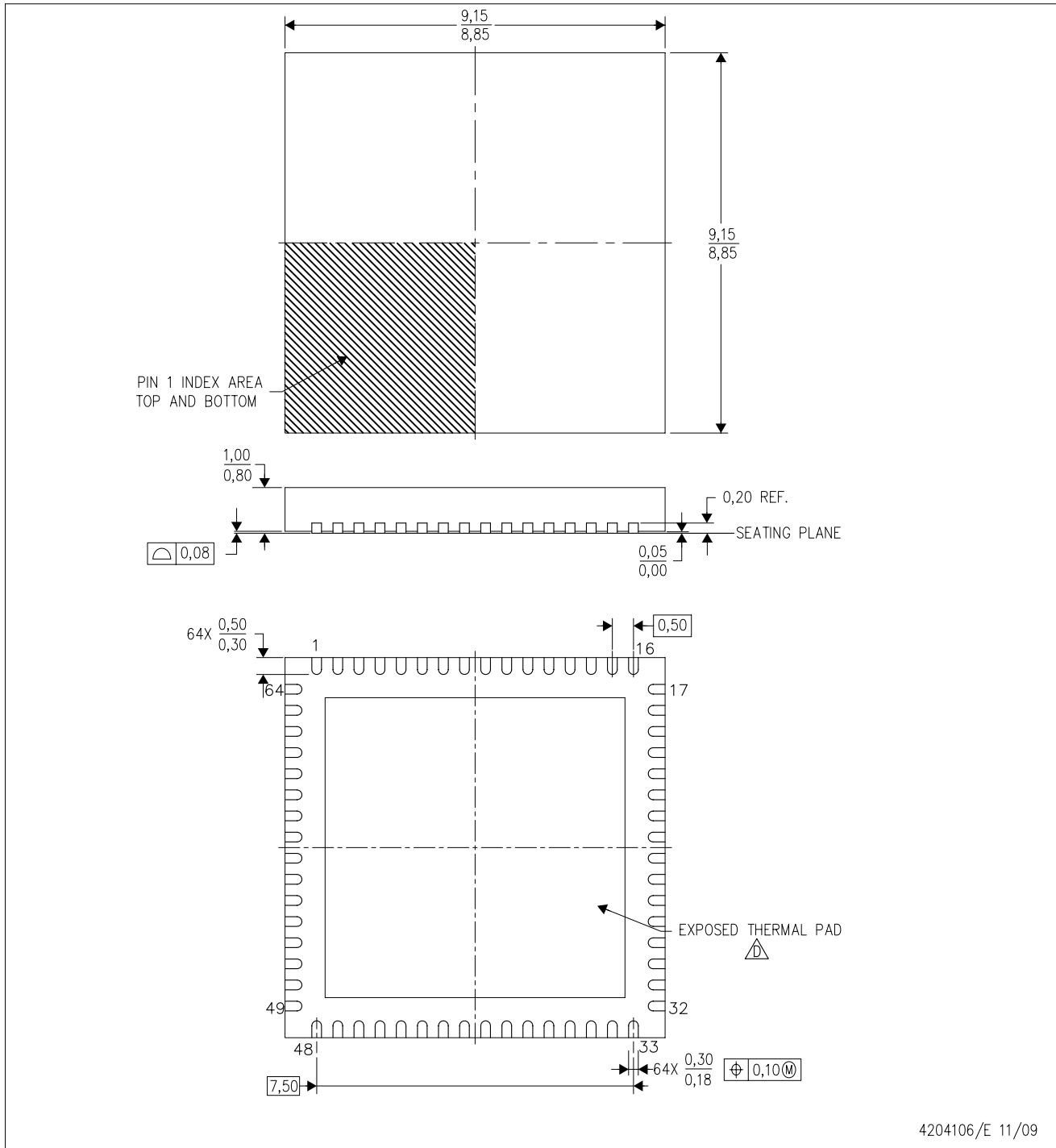

- NOTES:
- A. All linear dimensions are in millimeters. Dimensioning and tolerancing per ASME Y14.5-1994.
 - B. This drawing is subject to change without notice.
 - C. Quad Flatpack, No-leads (QFN) package configuration.
- \triangle The package thermal pad must be soldered to the board for thermal and mechanical performance. See the Product Data Sheet for details regarding the exposed thermal pad dimensions.

THERMAL INFORMATION

This package incorporates an exposed thermal pad that is designed to be attached directly to an external heatsink. The thermal pad must be soldered directly to the printed circuit board (PCB). After soldering, the PCB can be used as a heatsink. In addition, through the use of thermal vias, the thermal pad can be attached directly to the appropriate copper plane shown in the electrical schematic for the device, or alternatively, can be attached to a special heatsink structure designed into the PCB. This design optimizes the heat transfer from the integrated circuit (IC).

For information on the Quad Flatpack No-Lead (QFN) package and its advantages, refer to Application Report, QFN/SON PCB Attachment, Texas Instruments Literature No. SLUA271. This document is available at www.ti.com.

The exposed thermal pad dimensions for this package are shown in the following illustration.

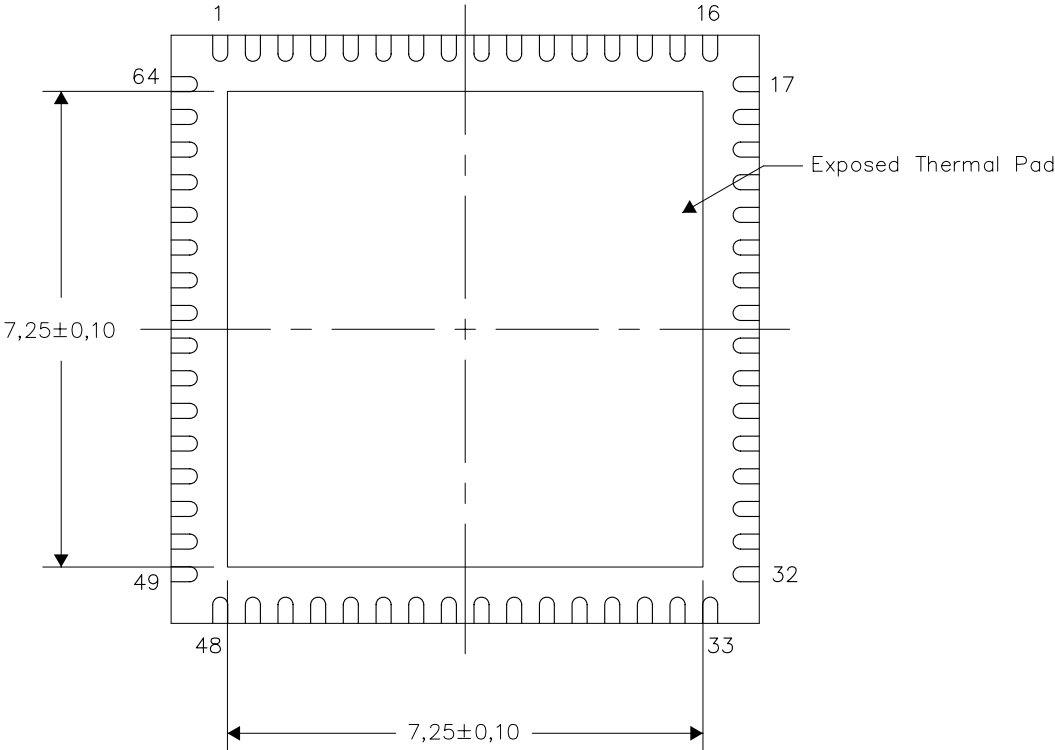

Bottom View

Exposed Thermal Pad Dimensions

4206192-2/M 11/10

NOTE: A. All linear dimensions are in millimeters

[查询"ADS5485"供应商](#)

RGC (S-PVQFN-N64)

PLASTIC QUAD FLATPACK NO-LEAD

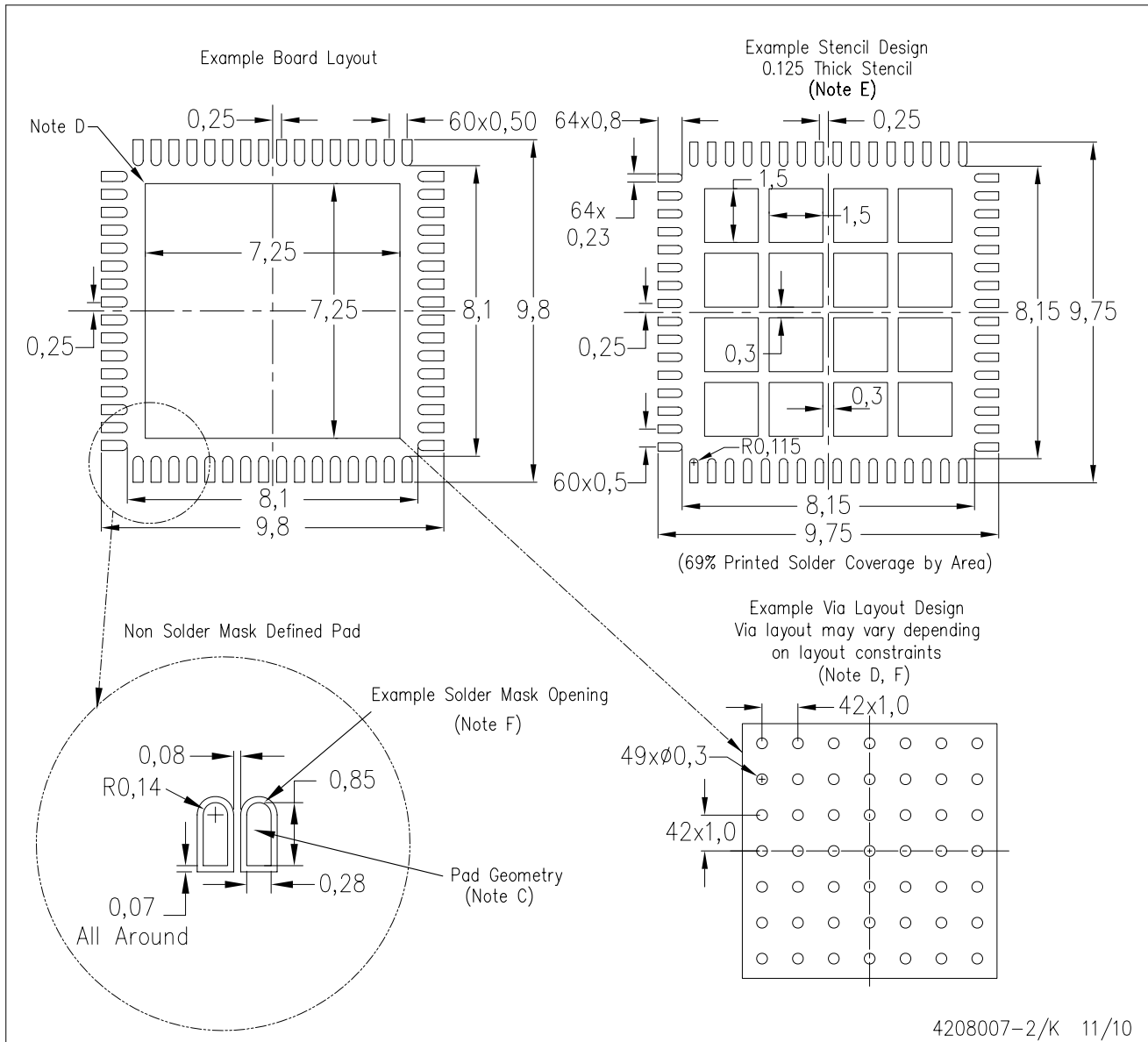

- NOTES:
- A. All linear dimensions are in millimeters.
 - B. This drawing is subject to change without notice.
 - C. Publication IPC-7351 is recommended for alternate designs.
 - D. This package is designed to be soldered to a thermal pad on the board. Refer to Application Note, Quad Flat-Pack Packages, Texas Instruments Literature No. SLUA271, and also the Product Data Sheets for specific thermal information, via requirements, and recommended board layout. These documents are available at www.ti.com <<http://www.ti.com>>.
 - E. Laser cutting apertures with trapezoidal walls and also rounding corners will offer better paste release. Customers should contact their board assembly site for stencil design recommendations. Refer to IPC 7525 for stencil design considerations.
 - F. Customers should contact their board fabrication site for recommended solder mask tolerances and via tenting recommendations for vias placed in thermal pad.

IMPORTANT NOTICE

Texas Instruments Incorporated and its subsidiaries (TI) reserve the right to make corrections, modifications, enhancements, improvements, and other changes to its products and services at any time and to discontinue any product or service without notice. Customers should obtain the latest relevant information before placing orders and should verify that such information is current and complete. All products are sold subject to TI's terms and conditions of sale supplied at the time of order acknowledgment.

TI warrants performance of its hardware products to the specifications applicable at the time of sale in accordance with TI's standard warranty. Testing and other quality control techniques are used to the extent TI deems necessary to support this warranty. Except where mandated by government requirements, testing of all parameters of each product is not necessarily performed.

TI assumes no liability for applications assistance or customer product design. Customers are responsible for their products and applications using TI components. To minimize the risks associated with customer products and applications, customers should provide adequate design and operating safeguards.

TI does not warrant or represent that any license, either express or implied, is granted under any TI patent right, copyright, mask work right, or other TI intellectual property right relating to any combination, machine, or process in which TI products or services are used. Information published by TI regarding third-party products or services does not constitute a license from TI to use such products or services or a warranty or endorsement thereof. Use of such information may require a license from a third party under the patents or other intellectual property of the third party, or a license from TI under the patents or other intellectual property of TI.

Reproduction of TI information in TI data books or data sheets is permissible only if reproduction is without alteration and is accompanied by all associated warranties, conditions, limitations, and notices. Reproduction of this information with alteration is an unfair and deceptive business practice. TI is not responsible or liable for such altered documentation. Information of third parties may be subject to additional restrictions.

Resale of TI products or services with statements different from or beyond the parameters stated by TI for that product or service voids all express and any implied warranties for the associated TI product or service and is an unfair and deceptive business practice. TI is not responsible or liable for any such statements.

TI products are not authorized for use in safety-critical applications (such as life support) where a failure of the TI product would reasonably be expected to cause severe personal injury or death, unless officers of the parties have executed an agreement specifically governing such use. Buyers represent that they have all necessary expertise in the safety and regulatory ramifications of their applications, and acknowledge and agree that they are solely responsible for all legal, regulatory and safety-related requirements concerning their products and any use of TI products in such safety-critical applications, notwithstanding any applications-related information or support that may be provided by TI. Further, Buyers must fully indemnify TI and its representatives against any damages arising out of the use of TI products in such safety-critical applications.

TI products are neither designed nor intended for use in military/aerospace applications or environments unless the TI products are specifically designated by TI as military-grade or "enhanced plastic." Only products designated by TI as military-grade meet military specifications. Buyers acknowledge and agree that any such use of TI products which TI has not designated as military-grade is solely at the Buyer's risk, and that they are solely responsible for compliance with all legal and regulatory requirements in connection with such use.

TI products are neither designed nor intended for use in automotive applications or environments unless the specific TI products are designated by TI as compliant with ISO/TS 16949 requirements. Buyers acknowledge and agree that, if they use any non-designated products in automotive applications, TI will not be responsible for any failure to meet such requirements.

Following are URLs where you can obtain information on other Texas Instruments products and application solutions:

| Products | | Applications | |
|-----------------------------|--|----------------------------|--|
| Amplifiers | amplifier.ti.com | Audio | www.ti.com/audio |
| Data Converters | dataconverter.ti.com | Automotive | www.ti.com/automotive |
| DLP® Products | www.dlp.com | Communications and Telecom | www.ti.com/communications |
| DSP | dsp.ti.com | Computers and Peripherals | www.ti.com/computers |
| Clocks and Timers | www.ti.com/clocks | Consumer Electronics | www.ti.com/consumer-apps |
| Interface | interface.ti.com | Energy | www.ti.com/energy |
| Logic | logic.ti.com | Industrial | www.ti.com/industrial |
| Power Mgmt | power.ti.com | Medical | www.ti.com/medical |
| Microcontrollers | microcontroller.ti.com | Security | www.ti.com/security |
| RFID | www.ti-rfid.com | Space, Avionics & Defense | www.ti.com/space-avionics-defense |
| RF/IF and ZigBee® Solutions | www.ti.com/lprf | Video and Imaging | www.ti.com/video |
| | | Wireless | www.ti.com/wireless-apps |