

## Darlington Transistor

# 2SD1789

## (TP4L20)

± 4A NPN

### OUTLINE DIMENSIONS

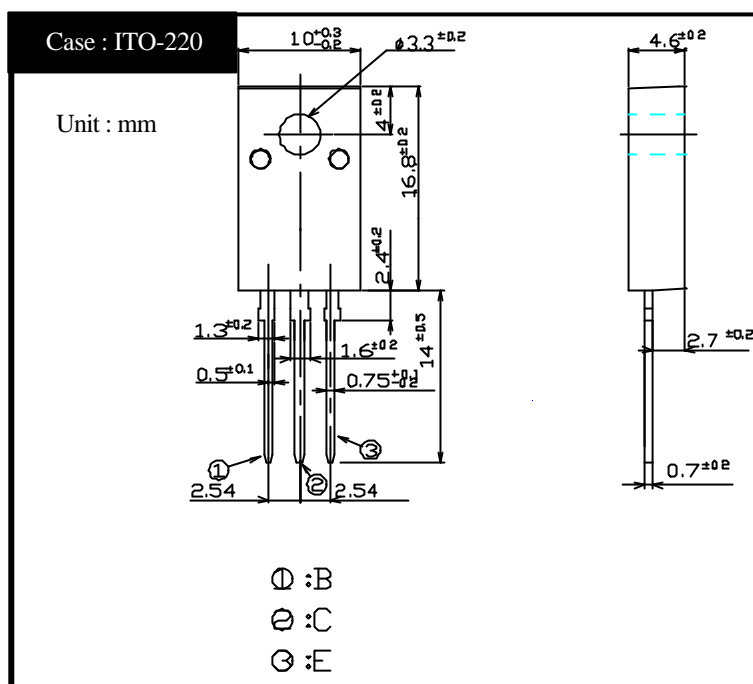

### RATINGS

#### Absolute Maximum Ratings

Item	Symbol	Conditions	Ratings	Unit
Storage Temperature	T <sub>stg</sub>		-55 ~ +150	
Junction Temperature	T <sub>j</sub>		+150	
Collector to Base Voltage	V <sub>CB0</sub>		200	V
Collector to Emitter Voltage	V <sub>CEO</sub>		200	V
Emitter to Base Voltage	V <sub>EBO</sub>		7	V
Collector Current DC	I <sub>C</sub>		± 4	A
Collector Current Peak	I <sub>CP</sub>		± 6	A
Base Current DC	I <sub>B</sub>		0.3	A
Base Current Peak	I <sub>BP</sub>		0.5	A
Total Transistor Dissipation	P <sub>T</sub>	T <sub>C</sub> = 25	25	W
Dielectric Strength	V <sub>dis</sub>	Terminals to case AC 1 minute	2	kV
Mounting Torque	TOR	(Recommended torque : 0.3N·m )	0.5	N·m

#### Electrical Characteristics (T<sub>c</sub>=25 )

Item	Symbol	Conditions	Ratings	Unit
Collector Cutoff Current	I <sub>CBO</sub>	V <sub>CB</sub> = 200V	Max 0.1	mA
	I <sub>CEO</sub>	V <sub>CE</sub> = 200V	Max 0.1	
Emitter Cutoff Current	I <sub>EBO</sub>	V <sub>EB</sub> = 7V	Max 5	mA
DC Current Gain	h <sub>FE</sub>	V <sub>CE</sub> = 3V, I <sub>C</sub> = 1A	Min 1,500	
			Max 30,000	
Collector to Emitter Saturation Voltage	V <sub>CE(sat)</sub>	I <sub>C</sub> = 1A	Max 1.5	V
Base to Emitter Saturation Voltage	V <sub>BE(sat)</sub>	I <sub>B</sub> = 2mA	Max 2.0	V
Thermal Resistance	θ <sub>JC</sub>	Junction to case	Max 5.0	/W
Transition Frequency	f <sub>T</sub>	V <sub>CE</sub> = 10V, I <sub>C</sub> = 0.4A	TYP 20	MHz
Turn on Time	t <sub>on</sub>	I <sub>C</sub> = 1A I <sub>B1</sub> = I <sub>B2</sub> = 2mA R <sub>L</sub> = 25 V <sub>BB2</sub> = 4V	Max 2	μs
Storage Time	t <sub>s</sub>		Max 12	
Fall Time	t <sub>f</sub>		Max 5	

# 2SD1789 $h_{FE} - I_C$

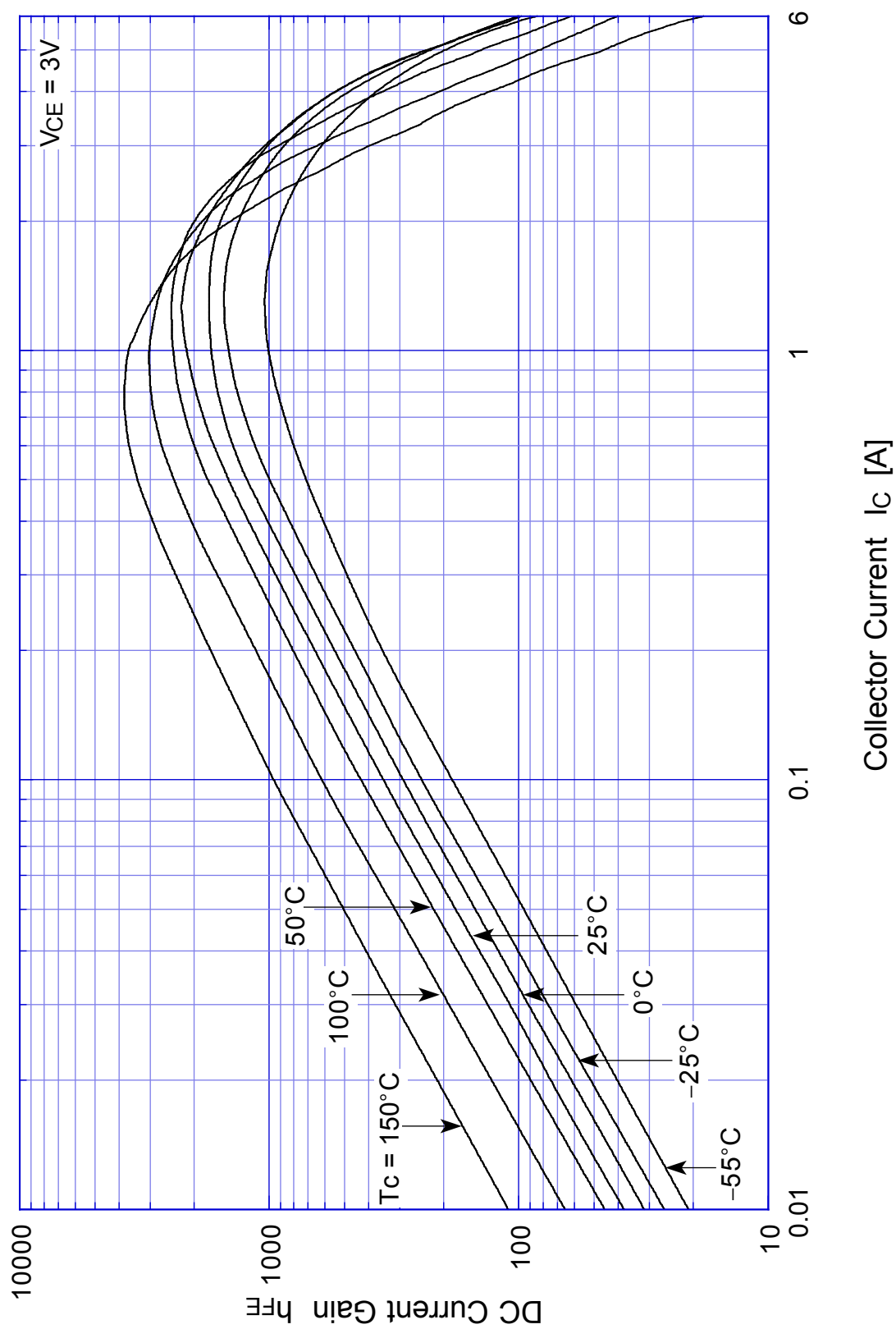

## 2SD1789 Saturation Voltage

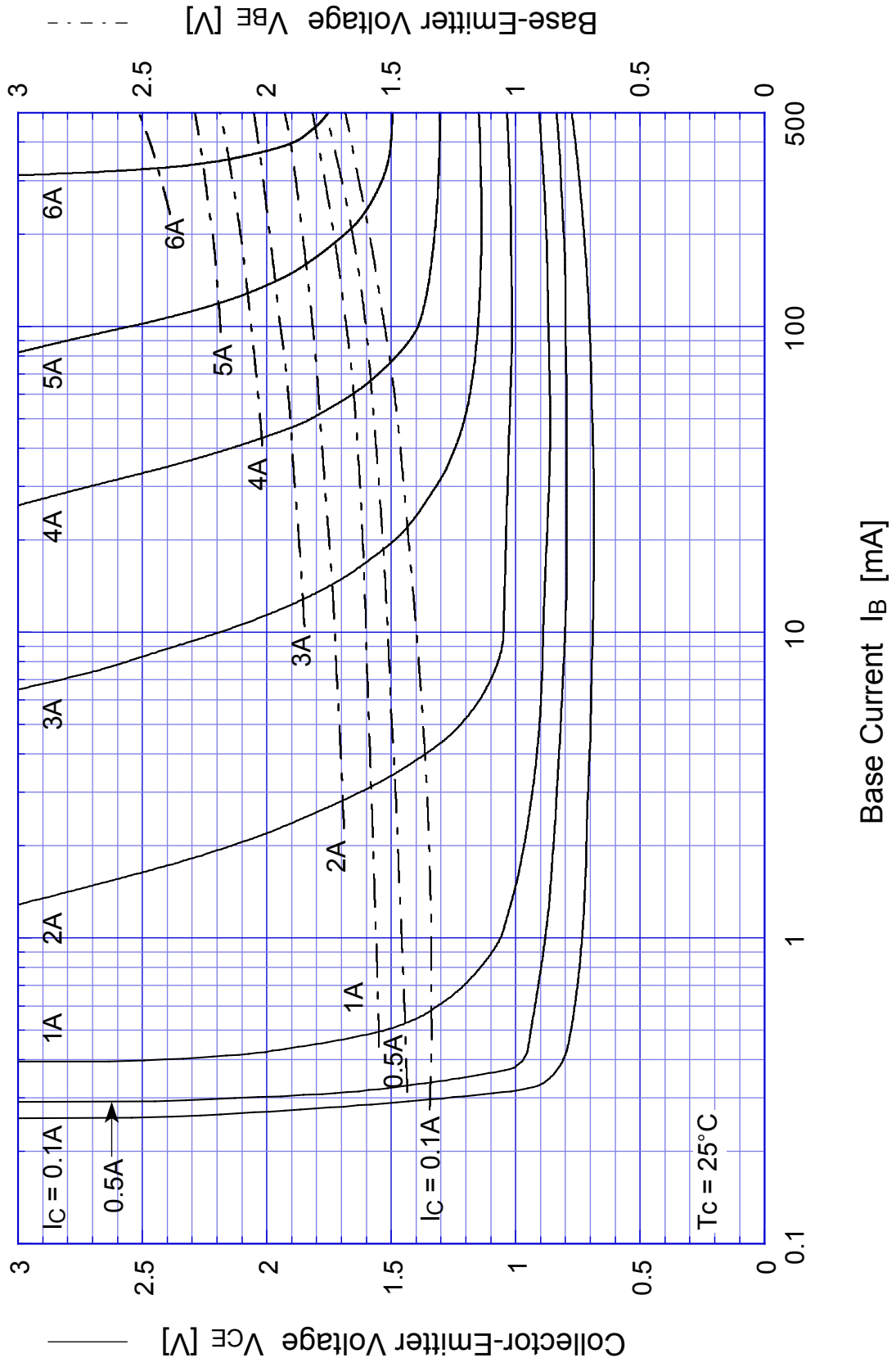

## 2SD1789 Switching Time - $I_C$

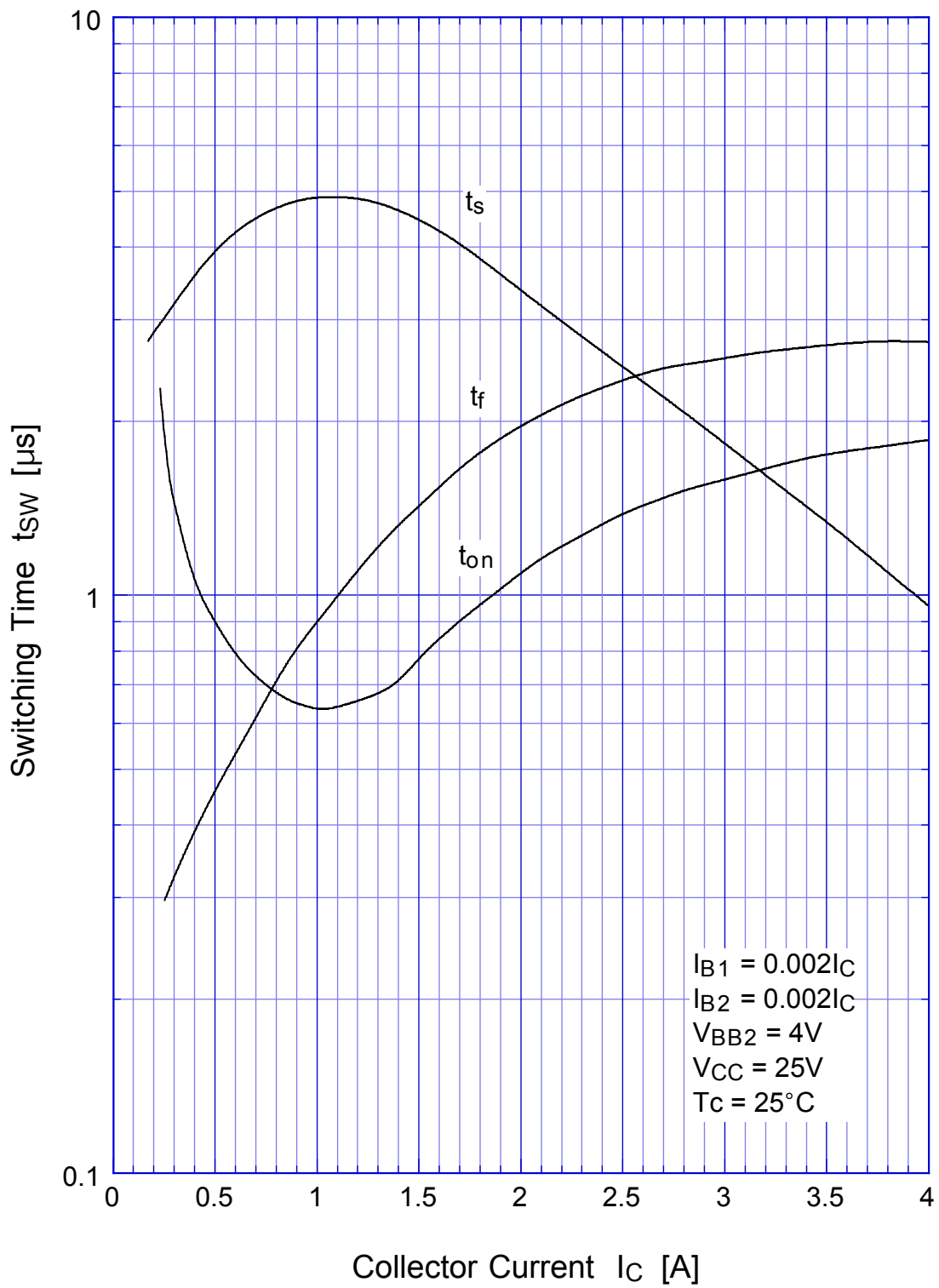

## 2SD1789 Switching Time - Tc

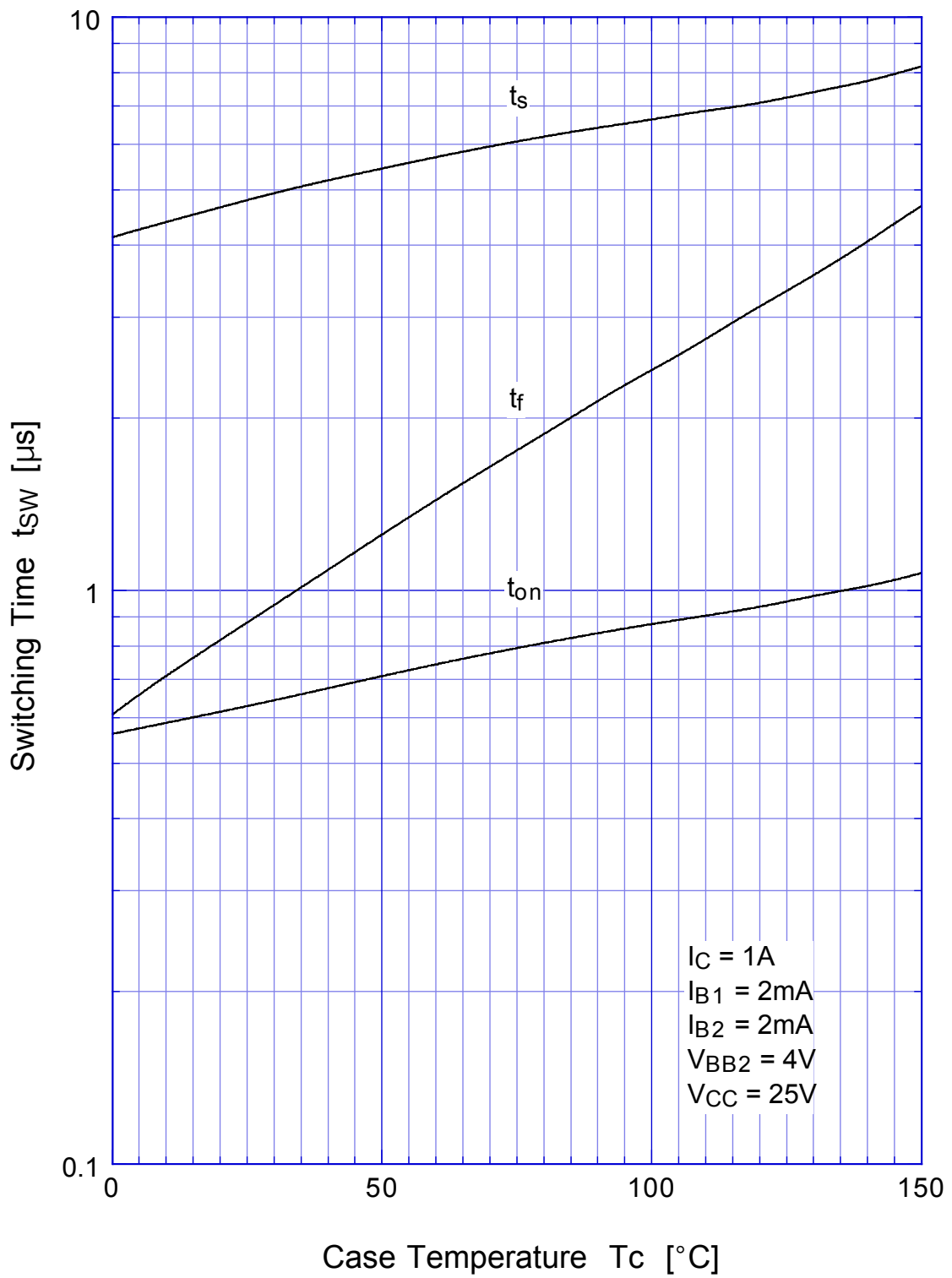

### 2SD1789 Transient Thermal Impedance

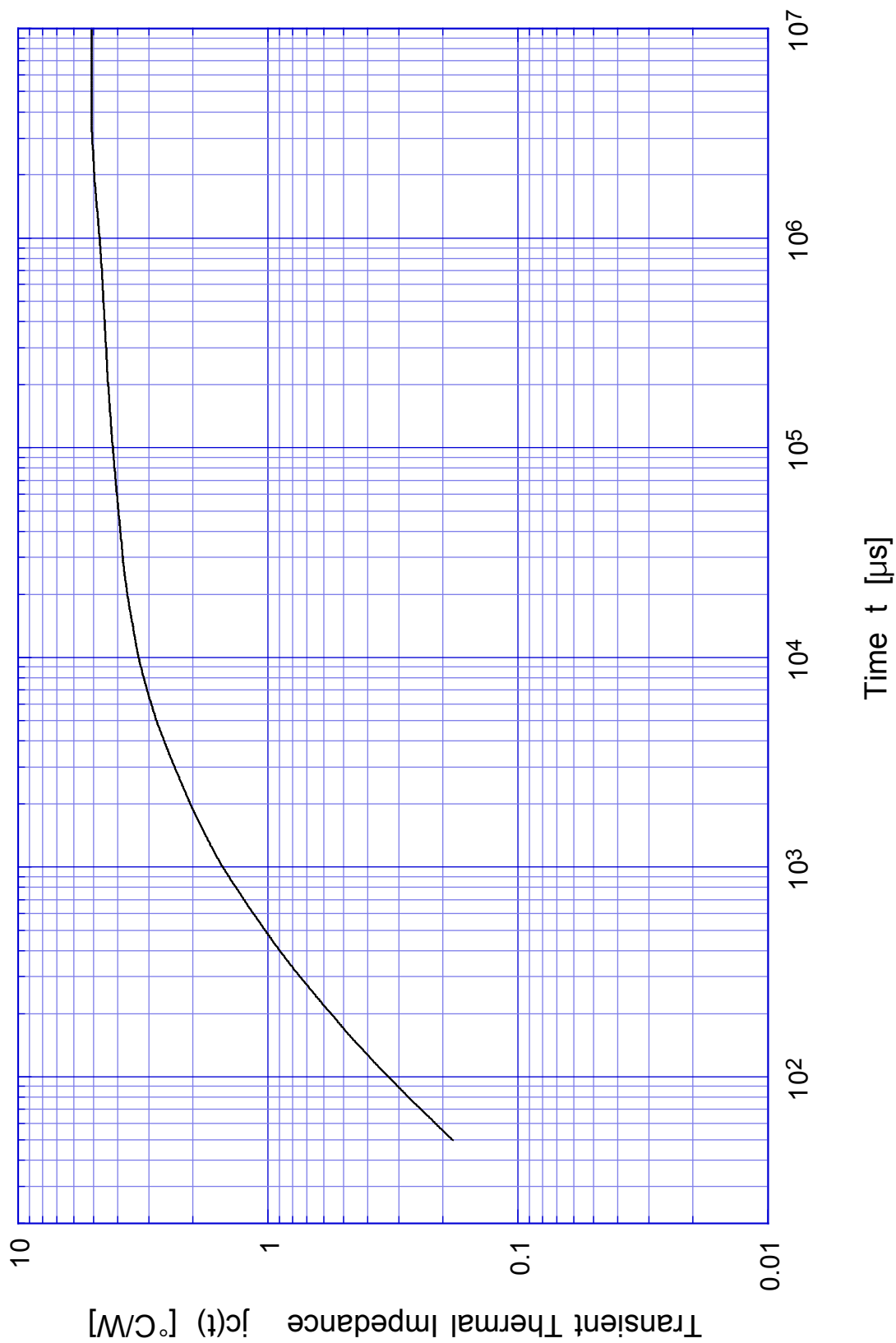

## 2SD1789 Collector Current Derating

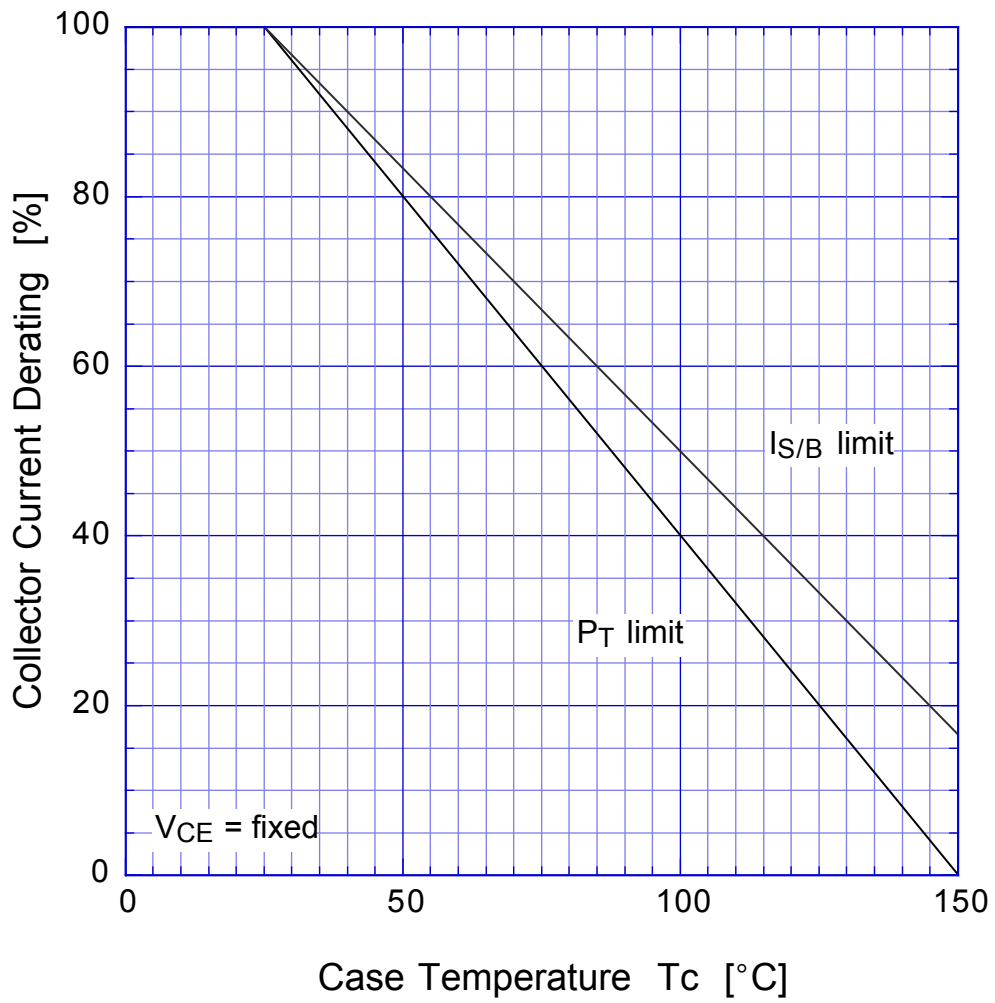

# 2SD1789

$V_{EC} - I_C$

