

查询"CTDD1106S-0505S-1"供应商

CTDD1106S-S Series

Fixed Input Isolated & Unregulated
1W Output, Single Output

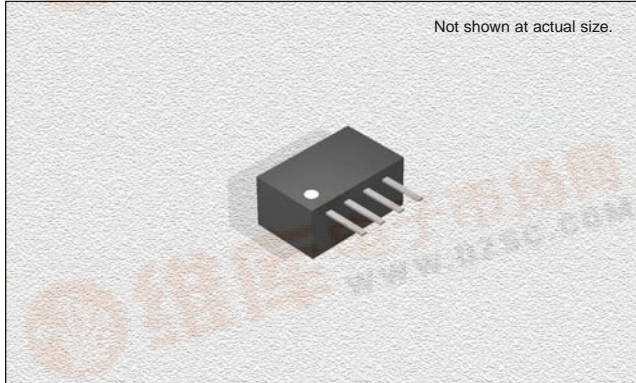

FEATURES

- Efficiency:** To 80%
- Temperature Range:** -40°C to 85°C
- Isolation:** 1KVDC
- Package:** UL94-V0
- Miscellaneous:** Single Output Voltage. No heatsink required. No external components required. Industry standard pinout. Small footprint. Custom service available.
- Samples available.**

CHARACTERISTICS

- Short Circuit Protection:** 1 second
- Temperature Rise at Full Load:** 25°C Max. 15°C Typ.
- Cooling:** Free air convection
- Operating Temperature Range:** -40°C to +85°C
- Storage Temperature Range:** -55°C to +125°C
- Lead Temperature:** 300°C (1.5mm from case for 10 seconds)
- Storage Humidity Range:** ≤ 95%
- Case Material:** Plastic (UL94-V0)
- MTBF:** >1,000,000 hours

SPECIFICATIONS

Part Number	Vin Nom.	Input Range	Vout	Iout Max. (mA)	Iout Min. (mA)	Effi(Typ.)
CTDD1106S-0505S-1	5VDC	4.5-5.5VDC	5VDC	200	20	78%
CTDD1106S-0509S-1	5VDC	4.5-5.5VDC	9VDC	111	12	79%
CTDD1106S-0512S-1	5VDC	4.5-5.5VDC	12VDC	83	9	80%
CTDD1106S-0515S-1	5VDC	4.5-5.5VDC	15VDC	67	7	78%
CTDD1106S-1205S-1	12VDC	10.8-13.2VDC	5VDC	200	20	78%
CTDD1106S-1209S-1	12VDC	10.8-13.2VDC	9VDC	111	12	80%
CTDD1106S-1212S-1	12VDC	10.8-13.2VDC	12VDC	83	9	81%
CTDD1106S-1215S-1	12VDC	10.8-13.2VDC	15VDC	67	7	79%
CTDD1106S-2405S-1	24VDC	21.6-26.4VDC	5VDC	200	20	79%
CTDD1106S-2409S-1	24VDC	21.6-26.4VDC	9VDC	111	12	80%
CTDD1106S-2412S-1	24VDC	21.6-26.4VDC	12VDC	83	9	81%
CTDD1106S-2415S-1	24VDC	21.6-26.4VDC	15VDC	67	7	79%

ISOLATION SPECIFICATIONS

Item	Test Condition	MIN	TYP	MAX	Units
Isolation Voltage	Tested for 1 minute	1000			VDC
Isolation Resistance	Test at 500VDC	1000			MΩ

OUTPUT SPECIFICATIONS

Item	Test Condition	MIN	TYP	MAX	Units
Output Power		0.1		1	W
Line regulation	For Vin change of 1%			1.2	%
Load regulation	10% to 100% full load			15	%
Output voltage accuracy	See tolerance envelope graph				
Temperature drift	100% full load			0.03	%/°C
Output ripple	20MHz Bandwidth		50	75	mVp-p
Switching frequency	Full load, nominal input	100	150	200	KHz

Note:
1. All specifications measured at TA=25°C, humidity<75%, nominal input voltage and rated output load unless otherwise specified.

TYPICAL CHARACTERISTICS

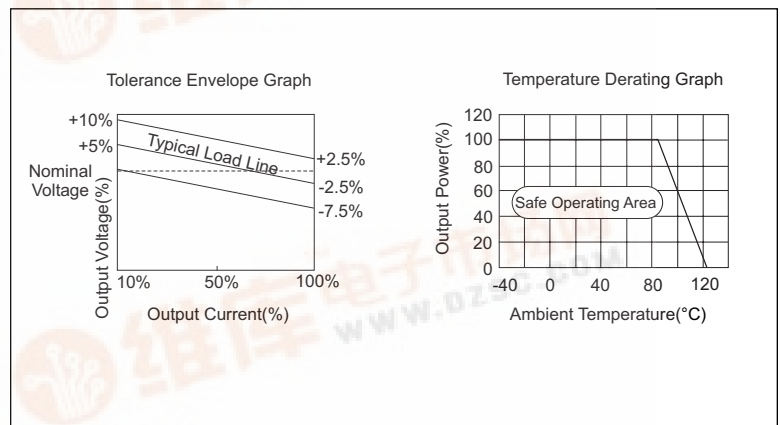

01.10.05

Manufacturer of Inductors, Chokes, Coils, Beads, Transformers & Toroids

800-684-5322 Inside US 949-453-1811 Outside US

Copyright © 2004 by CT Magnetics, DBA Central Technologies. All rights reserved.

CT Magnetics reserves the right to make improvements or change specifications without notice



[查询"CTDD1106S-0505S-1"供应商](#)

CTDD1106S-S Series

Fixed Input Isolated & Unregulated
1W Output, Single Output

OUTLINE DIMENSIONS & RECOMMENDED FOOTPRINT DETAILS

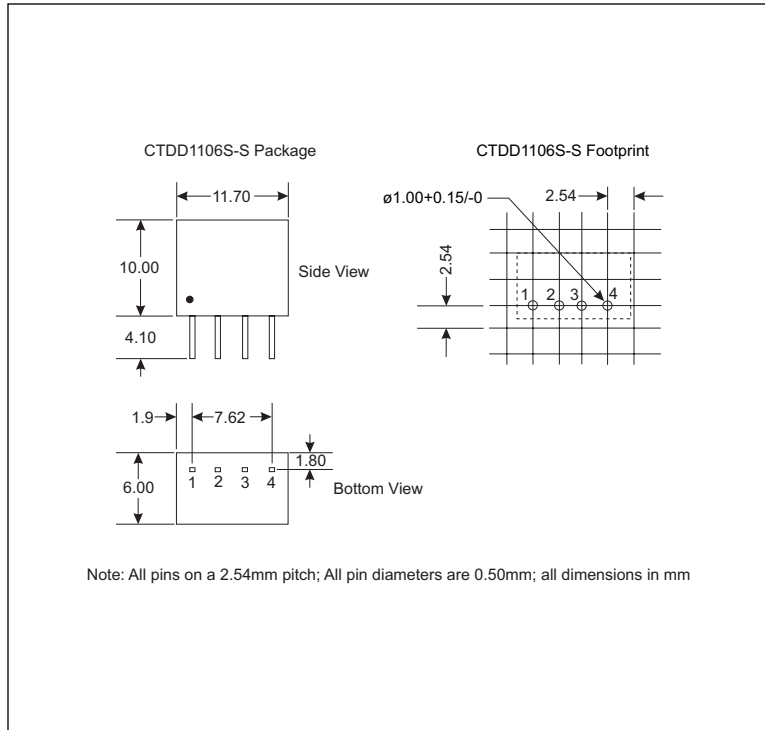

PIN CONNECTIONS

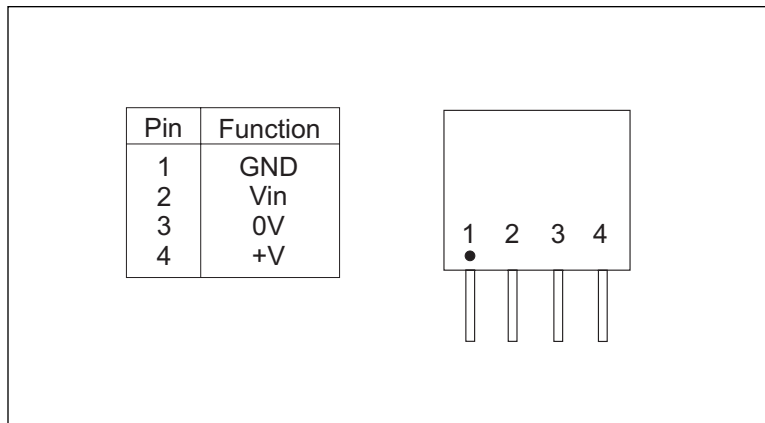

01.10.05