

2SK3446

Silicon N Channel Power MOS FET
Power Switching

RENESAS

ADE-208-1566F (Z)

7th. Edition
Jan. 2003

Features

- Capable of 2.5 V gate drive
- Low drive current
- Low on-resistance
- $R_{DS(on)} = 1.5 \Omega$ typ. (at $V_{GS} = 4 V$)

Outline

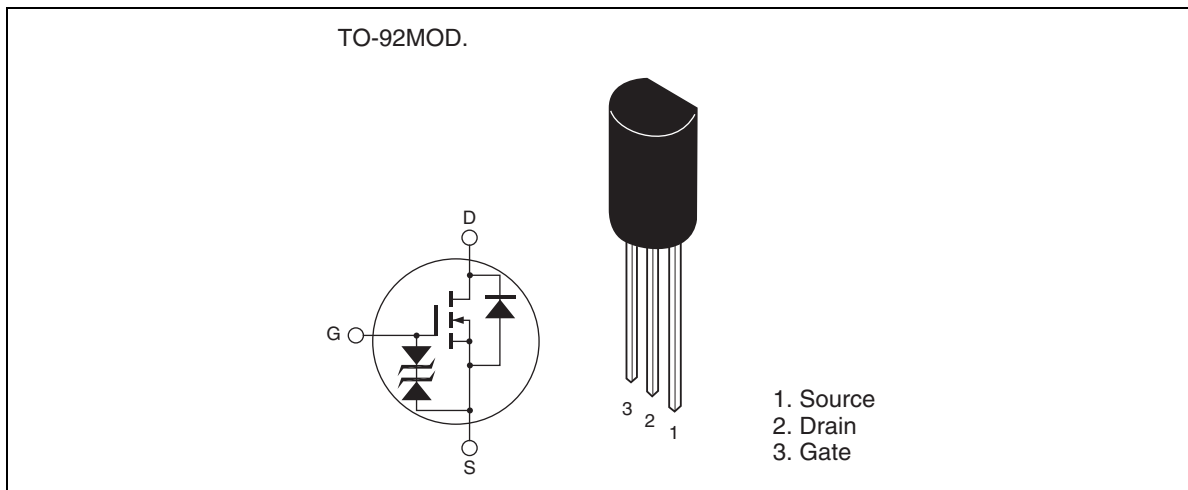

2SK3446

Absolute Maximum Ratings

(Ta = 25°C)

Item	Symbol	Ratings	Unit
Drain to source voltage	V _{DSS}	150	V
Gate to source voltage	V _{GSS}	±10	V
Drain current	I _D	1	A
Drain peak current	I _{D(pulse)} ^{Note1}	4	A
Body-drain diode reverse drain current	I _{DR}	1	A
Channel dissipation	Pch ^{Note2}	0.9	W
Channel temperature	Tch	150	°C
Storage temperature	Tstg	-55 to +150	°C

Notes: 1. PW ≤ 10 μs, duty cycle ≤ 1 %

2. Value at Ta = 25°C

Electrical Characteristics

(Ta = 25°C)

Item	Symbol	Min	Typ	Max	Unit	Test Conditions
Drain to source breakdown voltage	$V_{(BR)DSS}$	150	—	—	V	$I_D = 10 \text{ mA}, V_{GS} = 0$
Gate to source breakdown voltage	$V_{(BR)GSS}$	± 10	—	—	V	$I_G = \pm 100 \text{ }\mu\text{A}, V_{DS} = 0$
Gate to source leak current	I_{GSS}	—	—	± 10	μA	$V_{GS} = \pm 8 \text{ V}, V_{DS} = 0$
Zero gate voltage drain current	I_{DSS}	—	—	1	μA	$V_{DS} = 150 \text{ V}, V_{GS} = 0$
Gate to source cutoff voltage	$V_{GS(off)}$	0.5	—	1.5	V	$V_{DS} = 10 \text{ V}, I_D = 1 \text{ mA}$
Static drain to source on state resistance	$R_{DS(on)}$	—	1.5	1.95	Ω	$I_D = 0.5 \text{ A}, V_{GS} = 4 \text{ V}$ ^{Note3}
	$R_{DS(on)}$	—	1.9	2.5	Ω	$I_D = 0.5 \text{ A}, V_{GS} = 2.5 \text{ V}$ ^{Note3}
Forward transfer admittance	$ y_{fs} $	0.8	1.4	—	S	$I_D = 0.5 \text{ A}, V_{DS} = 10 \text{ V}$ ^{Note3}
Input capacitance	C_{iss}	—	98	—	pF	$V_{DS} = 10 \text{ V}$
Output capacitance	C_{oss}	—	31	—	pF	$V_{GS} = 0$
Reverse transfer capacitance	C_{rss}	—	14	—	pF	$f = 1 \text{ MHz}$
Total gate charge	Q_g	—	3.5	—	nC	$V_{DD} = 100 \text{ V}$
Gate to source charge	Q_{gs}	—	0.5	—	nC	$V_{GS} = 4 \text{ V}$
Gate to drain charge	Q_{gd}	—	1.8	—	nC	$I_D = 1 \text{ A}$
Turn-on delay time	$t_{d(on)}$	—	8	—	ns	$V_{GS} = 4 \text{ V}, I_D = 0.5 \text{ A}$
Rise time	t_r	—	12	—	ns	$R_L = 60 \text{ }\Omega$
Turn-off delay time	$t_{d(off)}$	—	34	—	ns	
Fall time	t_f	—	19	—	ns	
Body-drain diode forward voltage	V_{DF}	—	1.0	1.5	V	$I_F = 1 \text{ A}, V_{GS} = 0$ ^{Note3}
Body-drain diode reverse recovery time	t_{rr}	—	60	—	ns	$I_F = 1 \text{ A}, V_{GS} = 0$ $diF/dt = 100 \text{ A}/\mu\text{s}$

Notes: 3. Pulse test

2SK3446

Main Characteristics

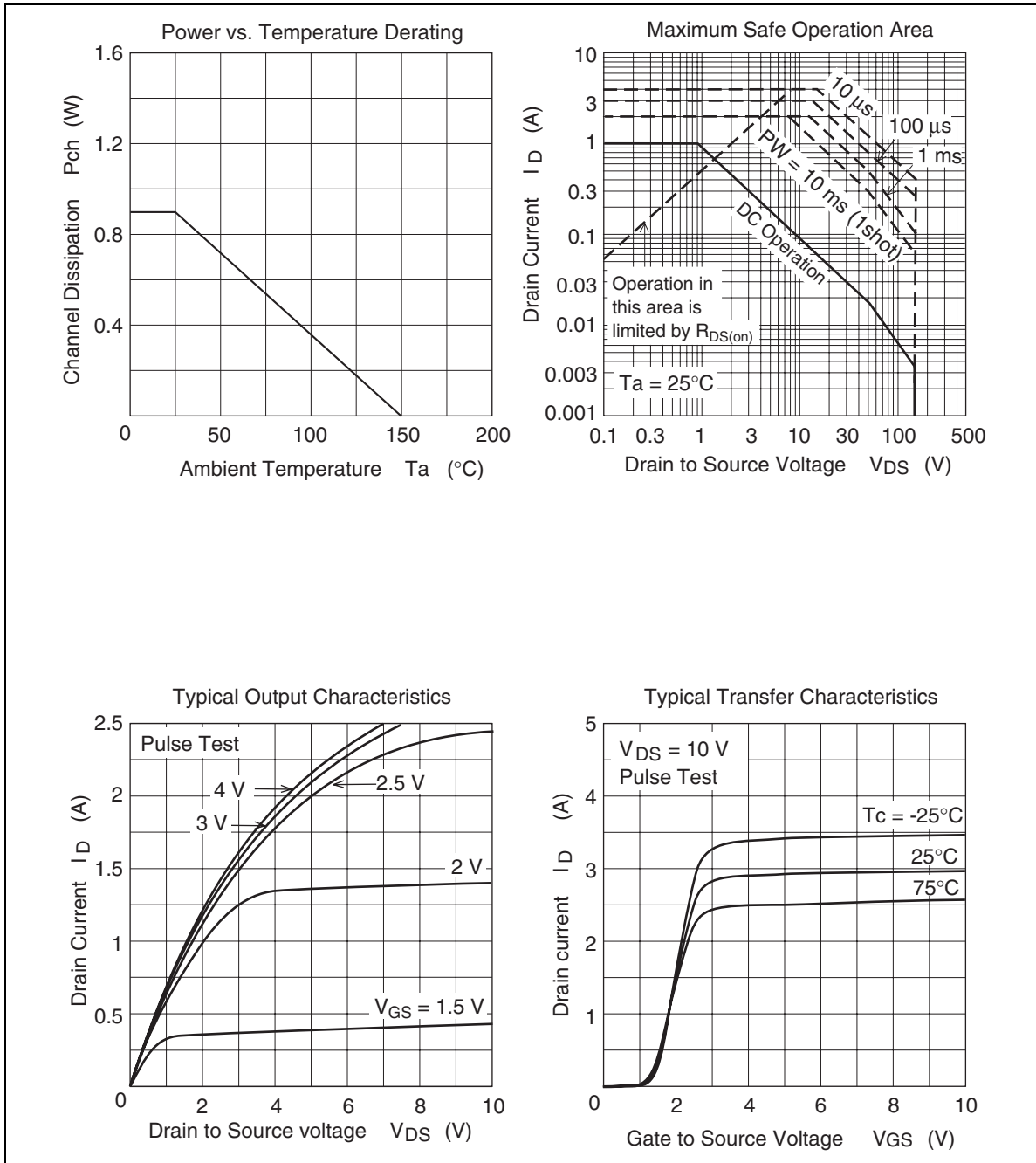

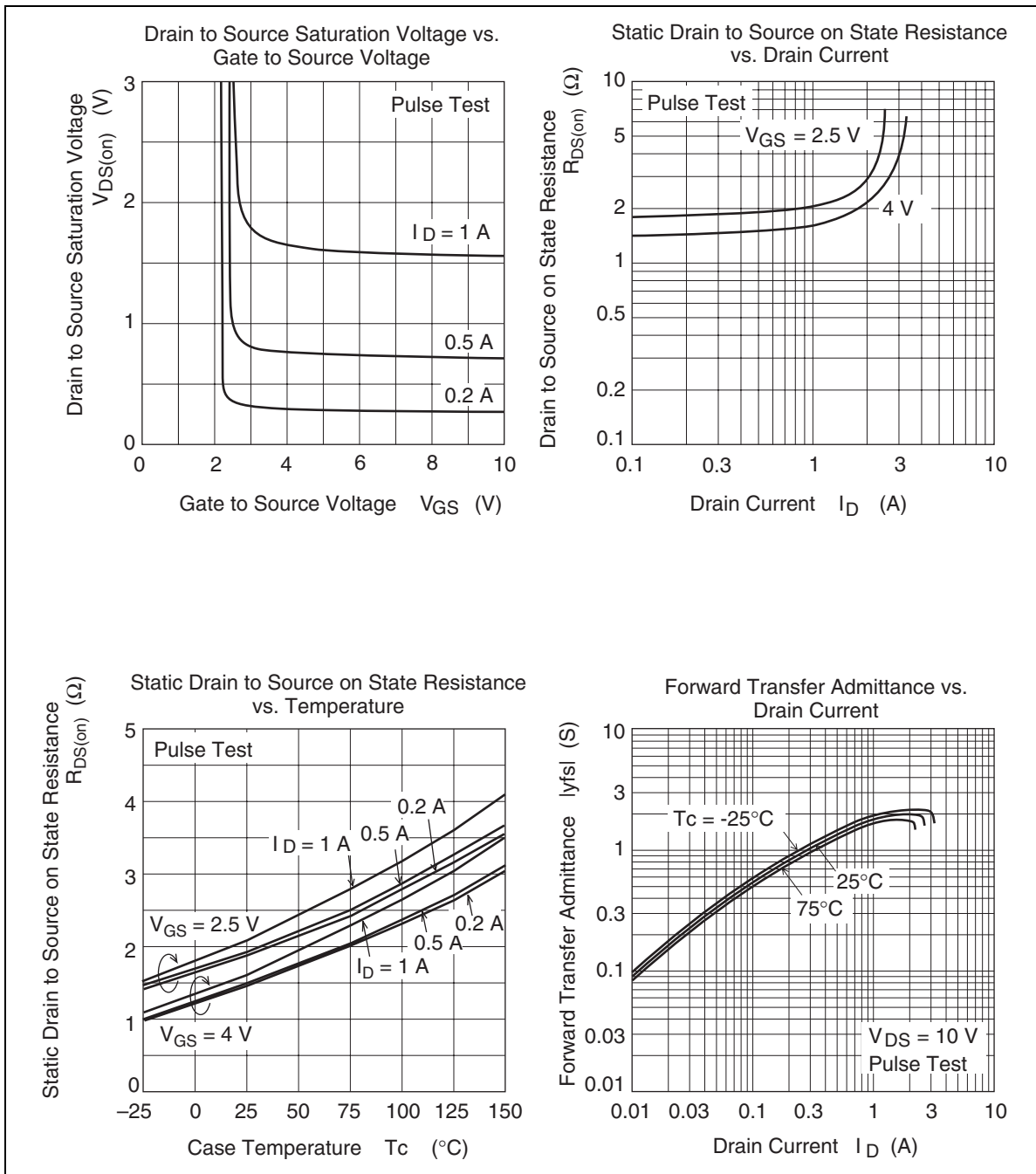

2SK3446

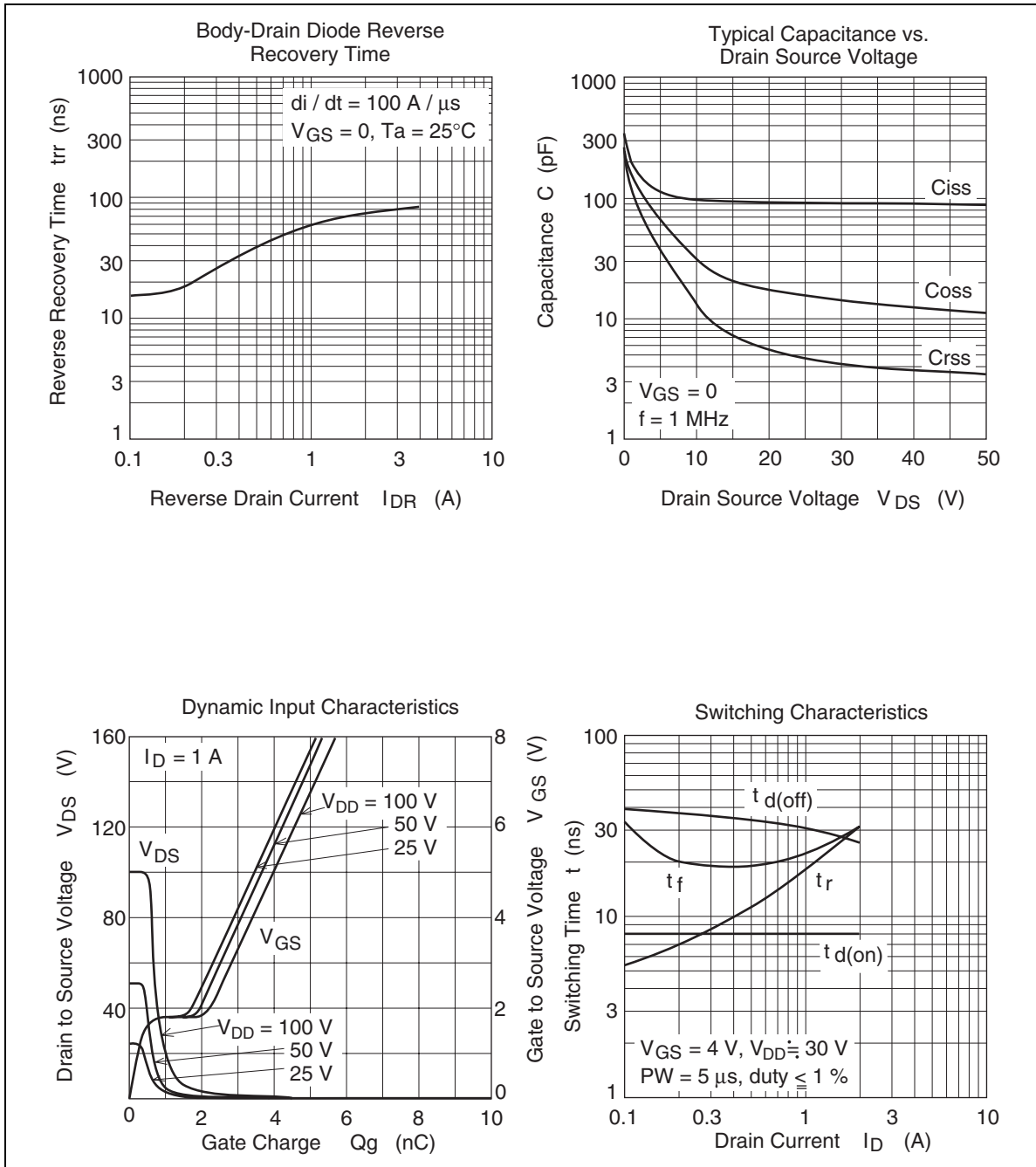

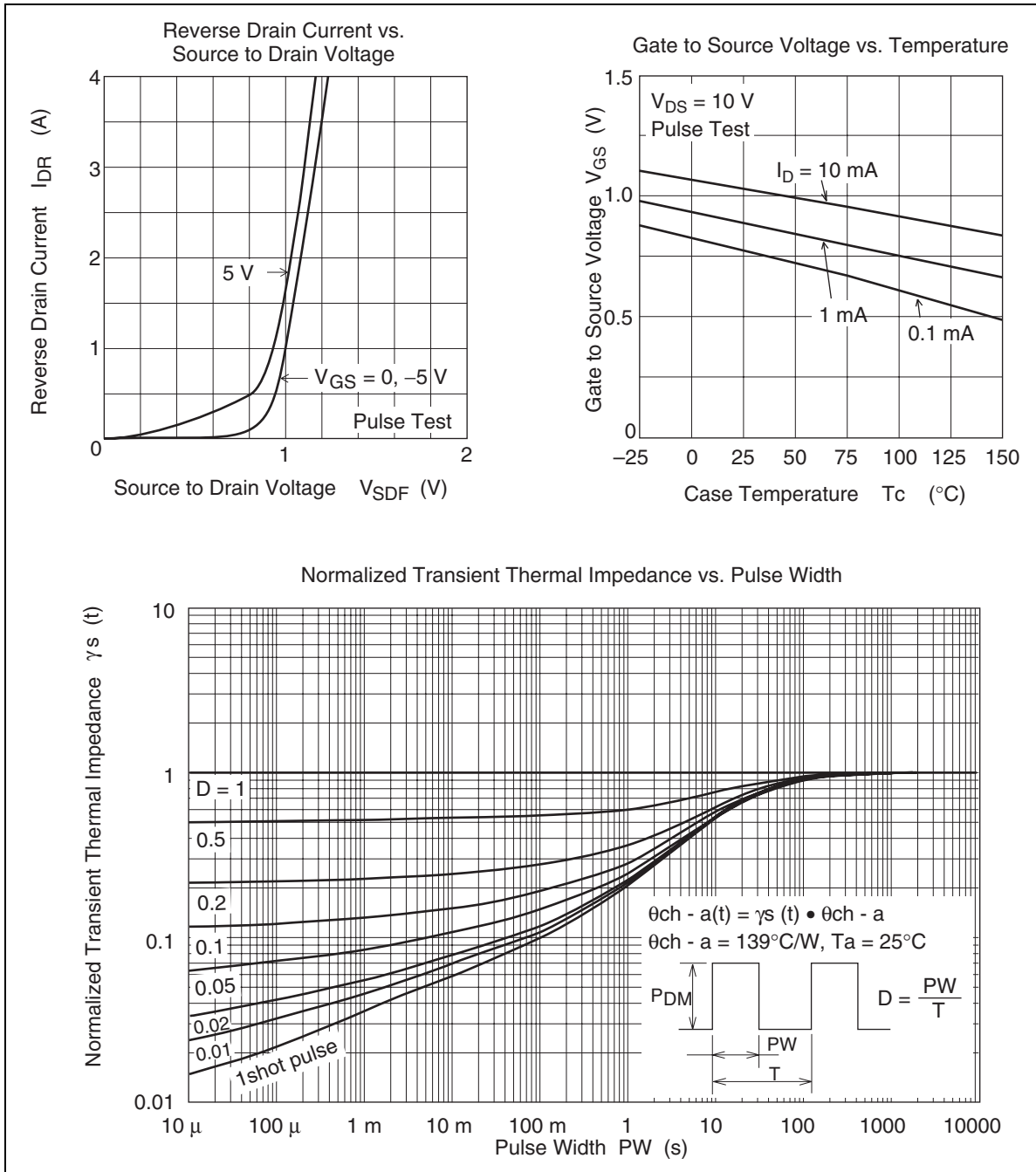

2SK3446

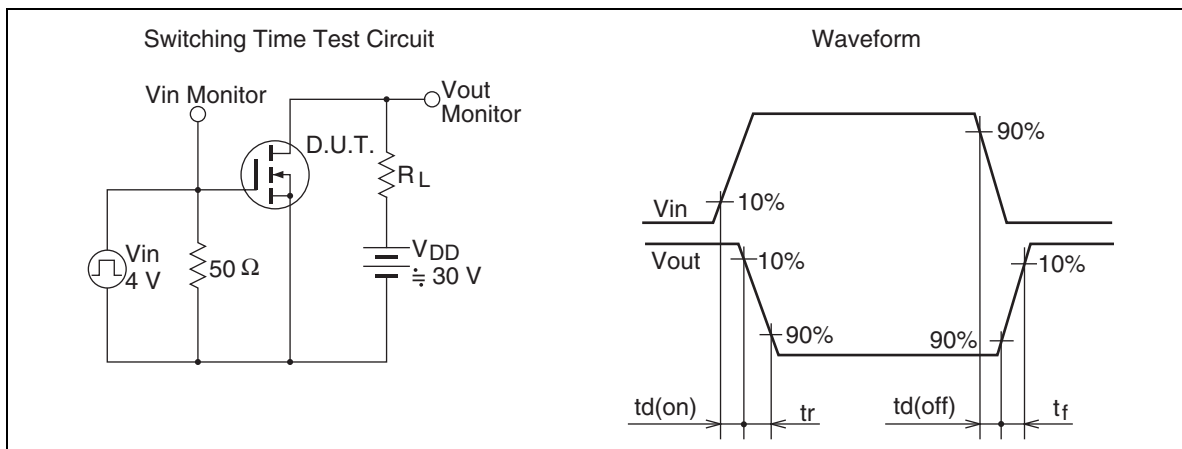

Package Dimensions

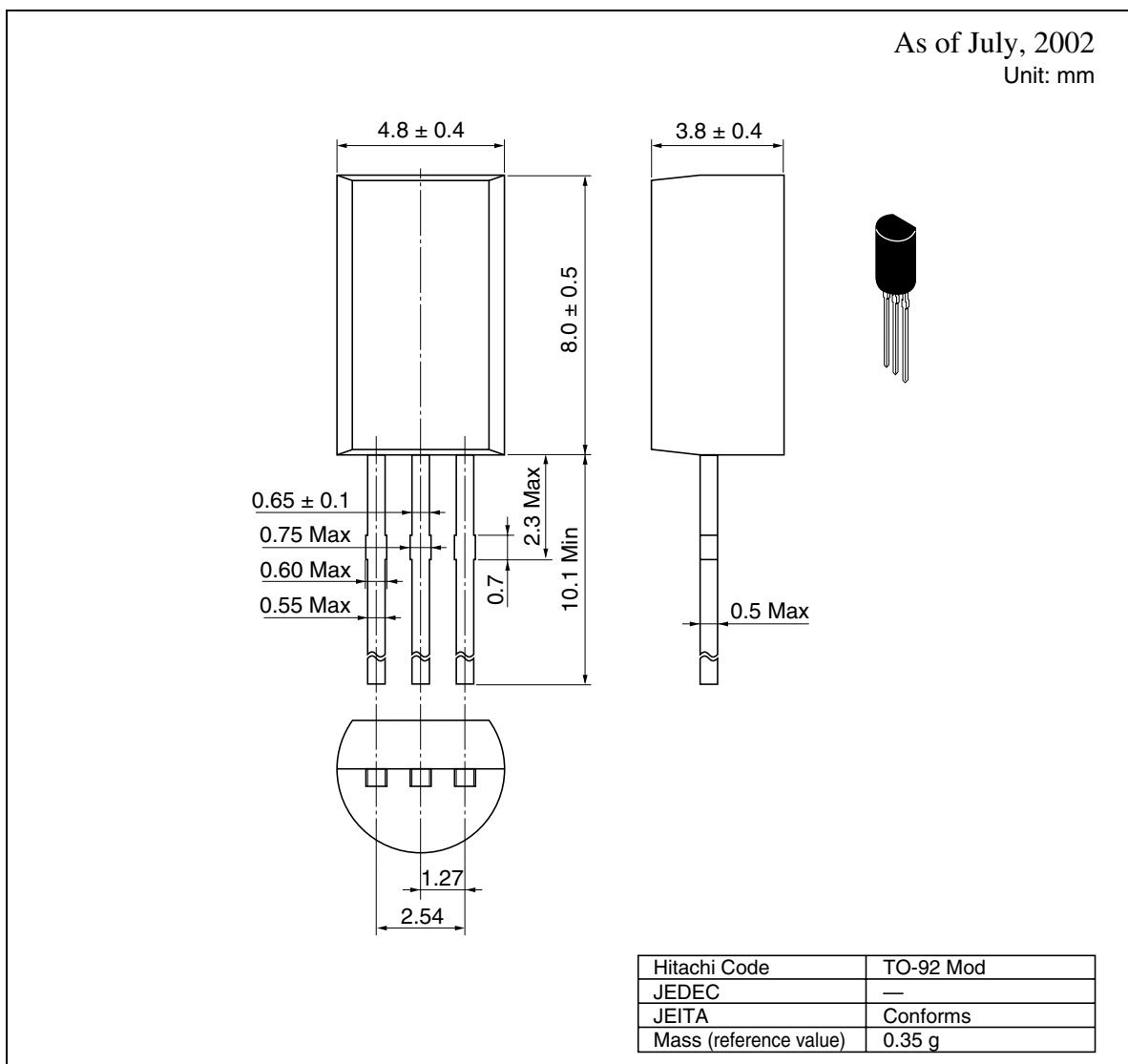

2SK3446

Disclaimer

1. Hitachi neither warrants nor grants licenses of any rights of Hitachi's or any third party's patent, copyright, trademark, or other intellectual property rights for information contained in this document. Hitachi bears no responsibility for problems that may arise with third party's rights, including intellectual property rights, in connection with use of the information contained in this document.
2. Products and product specifications may be subject to change without notice. Confirm that you have received the latest product standards or specifications before final design, purchase or use.
3. Hitachi makes every attempt to ensure that its products are of high quality and reliability. However, contact Hitachi's sales office before using the product in an application that demands especially high quality and reliability or where its failure or malfunction may directly threaten human life or cause risk of bodily injury, such as aerospace, aeronautics, nuclear power, combustion control, transportation, traffic, safety equipment or medical equipment for life support.
4. Design your application so that the product is used within the ranges guaranteed by Hitachi particularly for maximum rating, operating supply voltage range, heat radiation characteristics, installation conditions and other characteristics. Hitachi bears no responsibility for failure or damage when used beyond the guaranteed ranges. Even within the guaranteed ranges, consider normally foreseeable failure rates or failure modes in semiconductor devices and employ systemic measures such as fail-safes, so that the equipment incorporating Hitachi product does not cause bodily injury, fire or other consequential damage due to operation of the Hitachi product.
5. This product is not designed to be radiation resistant.
6. No one is permitted to reproduce or duplicate, in any form, the whole or part of this document without written approval from Hitachi.
7. Contact Hitachi's sales office for any questions regarding this document or Hitachi semiconductor products.

Sales Offices

HITACHI

Hitachi, Ltd.

Semiconductor & Integrated Circuits
Nippon Bldg., 2-6-2, Ohte-machi, Chiyoda-ku, Tokyo 100-0004, Japan
Tel: (03) 3270-2111 Fax: (03) 3270-5109

URL <http://www.hitachisemiconductor.com/>

For further information write to:

Hitachi Semiconductor
(America) Inc.
179 East Tasman Drive
San Jose, CA 95134
Tel: <1> (408) 433-1990
Fax: <1> (408) 433-0223

Hitachi Europe Ltd.
Electronic Components Group
Whitebrook Park
Lower Cookham Road
Maidenhead
Berkshire SL6 8YA, United Kingdom
Tel: <44> (1628) 585000
Fax: <44> (1628) 778322

Hitachi Europe GmbH
Electronic Components Group
Dornacher Str 3
D-85622 Feldkirchen
Postfach 201, D-85619 Feldkirchen
Germany
Tel: <49> (89) 9 9180-0
Fax: <49> (89) 9 29 30 00

Hitachi Asia Ltd.
Hitachi Tower
16 Collyer Quay #20-00
Singapore 049318
Tel : <65>-6538-6533/6538-8577
Fax : <65>-6538-6933/6538-3877
URL : <http://semiconductor.hitachi.com.sg>

Hitachi Asia Ltd.
(Taipei Branch Office)
4/F, No. 167, Tun Hwa North Road
Hung-Kuo Building
Taipei (105), Taiwan
Tel : <886>-(2)-2718-3666
Fax : <886>-(2)-2718-8180
Telex : 23222 HAS-TP
URL : <http://semiconductor.hitachi.com.tw>

Hitachi Asia (Hong Kong) Ltd.
Group III (Electronic Components)
7/F., North Tower
World Finance Centre,
Harbour City, Canton Road
Tsim Sha Tsui, Kowloon Hong Kong
Tel : <852>-2735-9218
Fax : <852>-2730-0281
URL : <http://semiconductor.hitachi.com.hk>

Copyright © Hitachi, Ltd., 2003. All rights reserved. Printed in Japan.
Colophon 7.0