

FEATURES

- Pin-programmable filter response
 - Update rate: 10 Hz or 16.7 Hz
- Pin-programmable in-amp gain
- Pin-programmable power-down and reset
- Status function
- Internal clock oscillator
- Internal bridge power-down switch
- Current
 - 115 μ A typical (gain = 1)
 - 330 μ A typical (gain = 128)
- Simultaneous 50 Hz/60 Hz rejection
- Power supply: 2.7 V to 5.25 V
- 40°C to +105°C temperature range
- Independent interface power supply
- Packages
 - 14-lead, narrow body SOIC
 - 16-lead TSSOP
- 2-wire serial interface (read-only device)
 - SPI compatible
 - Schmitt trigger on SCLK

APPLICATIONS

- Weigh scales
- Pressure measurement
- Industrial process control
- Portable instrumentation

GENERAL DESCRIPTION

The AD7780 is a complete low power front-end solution for bridge sensor products, including weigh scales, strain gages, and pressure sensors. It contains a precision, low power, 24-bit sigma-delta (Σ - Δ) ADC; an on-chip, low noise programmable gain amplifier (PGA); and an on-chip oscillator.

Consuming only 330 μ A, the AD7780 is particularly suitable for portable or battery-operated products where very low power is required. The AD7780 also has a power-down mode that allows the user to switch off the power to the bridge sensor and power down the AD7780 when not converting, thus increasing the battery life of the product.

For ease of use, all the features of the AD7780 are controlled by dedicated pins. Each time a data read occurs, eight status bits are appended to the 24-bit conversion. These status bits contain a pattern sequence that can be used to confirm the validity of the serial transfer.

Rev. A

Information furnished by Analog Devices is believed to be accurate and reliable. However, no responsibility is assumed by Analog Devices for its use, nor for any infringements of patents or other rights of third parties that may result from its use. Specifications subject to change without notice. No license is granted by implication or otherwise under any patent or patent rights of Analog Devices. Trademarks and registered trademarks are the property of their respective owners.

FUNCTIONAL BLOCK DIAGRAM

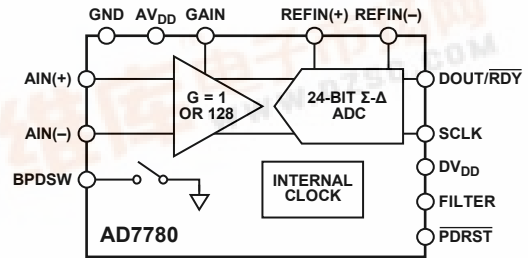

Figure 1.

Table 1.

Parameter	Gain = 128		Gain = 1	
	10 Hz	16.7 Hz	10 Hz	16.7 Hz
Output Data Rate	10 Hz	16.7 Hz	10 Hz	16.7 Hz
RMS Noise	44 nV	65 nV	2.4 μ V	2.7 μ V
P-P Resolution	17.6	17.1	18.8	18.7
Settling Time	300 ms	120 ms	300 ms	120 ms

The on-chip PGA has a gain of 1 or 128, supporting a full-scale differential input of ± 5 V or ± 39 mV. The device has two filter response options. The filter response at the 16.7 Hz update rate provides superior dynamic performance. The settling time is 120 ms at this update rate. At the 10 Hz update rate, the filter response provides greater than -45 dB of stop-band attenuation. In load cell applications, this stop-band rejection is useful to reject low frequency mechanical vibrations of the load cell. The settling time is 300 ms at this update rate. Simultaneous 50 Hz/60 Hz rejection occurs at both the 10 Hz and 16.7 Hz update rates.

The AD7780 operates with a power supply from 2.7 V to 5.25 V. It is available in a narrow body, 14-lead SOIC package and a 16-lead TSSOP package.

TABLE OF CONTENTS

Features	1	Power-Down/Reset ($\overline{\text{PDRST}}$)	12
Applications	1	Analog Input Channel	12
Functional Block Diagram	1	Bipolar Configuration	12
General Description	1	Data Output Coding	12
Revision History	2	Reference	12
Specifications	3	Bridge Power-Down Switch	13
Timing Characteristics	5	Digital Interface	13
Absolute Maximum Ratings	6	Applications Information	14
Thermal Resistance	6	Weigh Scales	14
ESD Caution	6	Performance in a Weigh Scale System	14
Pin Configurations and Function Descriptions	7	EMI Recommendations	14
Typical Performance Characteristics	8	Grounding and Layout	15
Output Noise and Resolution	10	Outline Dimensions	16
Theory of Operation	11	Ordering Guide	16
Filter, Data Rate, and Settling Time	11		
Gain	12		

REVISION HISTORY

9/09—Rev. 0 to Rev. A

Changes to Specifications Table	3
---------------------------------------	---

4/09—Revision 0: Initial Version

SPECIFICATIONS

$AV_{DD} = 2.7\text{ V to }5.25\text{ V}$, $V_{REF} = AV_{DD}$, $DV_{DD} = 2.7\text{ V to }5.25\text{ V}$, $GND = 0\text{ V}$, all specifications T_{MIN} to T_{MAX} , unless otherwise noted.¹

Table 2.

Parameter	Min	Typ	Max	Unit	Test Conditions/Comments
ADC CHANNEL					
Output Update Rate (f_{ADC})		10		Hz	FILTER = 1, settling time = $3/f_{ADC}$
		16.7		Hz	FILTER = 0, settling time = $2/f_{ADC}$
No Missing Codes ²	24			Bits	
Resolution Peak-to-Peak					See Table 7 and Table 8
RMS Noise					See Table 7 and Table 8
Integral Nonlinearity		±6		ppm of FSR	
Offset Error		±6		μV	Gain = 128 with FILTER = 1
		±200		μV	Gain = 1 with FILTER = 1
		±1		μV	Gain = 128 with FILTER = 0
		±2		μV	Gain = 1 with FILTER = 0
Offset Error Drift vs. Temperature		±10		nV/°C	Gain = 128
		±150		nV/°C	Gain = 1 with FILTER = 1
		±10		nV/°C	Gain = 1 with FILTER = 0
Full-Scale Error		±0.25		% of FS	
Gain Drift vs. Temperature		±2		ppm/°C	
Power Supply Rejection		100		dB	Gain = 128, FILTER = 1, AIN = 7.81 mV
		120		dB	Gain = 128, FILTER = 0, AIN = 7.81 mV
Normal-Mode Rejection ²					
50 Hz, 60 Hz	63	75		dB	50 Hz ± 1 Hz, 60 Hz ± 1 Hz, $f_{ADC} = 16.7\text{ Hz}$
50 Hz, 60 Hz	72	90		dB	50 Hz ± 1 Hz, 60 Hz ± 1 Hz, $f_{ADC} = 10\text{ Hz}$
Common-Mode Rejection					
DC		90		dB	Gain = 1, AIN = 1 V
		90		dB	Gain = 128, AIN = 7.81 mV
50 Hz, 60 Hz		110		dB	50 Hz ± 1 Hz, 60 Hz ± 1 Hz
ANALOG INPUTS					
Differential Input Voltage Range		± V_{REF}/gain		V	$V_{REF} = \text{REFIN}(+) - \text{REFIN}(-)$, gain = 1 or 128
Absolute AIN Voltage Limits ²	GND + 100 mV		$AV_{DD} - 100\text{ mV}$	V	Gain = 1
	GND + 450 mV		$AV_{DD} - 1.1$	V	Gain = 128, FILTER = 0
	GND + 1.1		$AV_{DD} - 1.1$	V	Gain = 128, FILTER = 1, $AV_{DD} \leq 3.6\text{ V}$
	GND + 1.5		$AV_{DD} - 1.5$	V	Gain = 128, FILTER = 1, $AV_{DD} > 3.6\text{ V}$
Average Input Current		±1		nA	Gain = 1
		±250		pA typ	Gain = 128
Average Input Current Drift		±3		pA/°C	
REFERENCE					
External REFIN Voltage		AV_{DD}		V	REFIN = REFIN(+) – REFIN(-)
Reference Voltage Range ²	0.5		AV_{DD}	V	
Absolute REFIN Voltage Limits ²	GND – 30 mV		$AV_{DD} + 30\text{ mV}$	V	
Average Reference Input Current		400		nA/V	
Average Reference Input Current Drift		±0.15		nA/V/°C	
Normal-Mode Rejection					Same as for analog inputs
Common-Mode Rejection		110		dB	
BRIDGE POWER-DOWN SWITCH (BPDSW)					
R_{ON}			9	Ω	Controlled via the $\overline{\text{PDRST}}$ pin
Allowable Current ²			30	mA	Continuous current
INTERNAL CLOCK					
Frequency	64 – 3%		64 + 3%	kHz	
Duty Cycle		50:50		%	

AD7780

[查询"AD7780"供应商](#)

Parameter	Min	Typ	Max	Unit	Test Conditions/Comments
LOGIC INPUTS					
SCLK, FILTER, GAIN, $\overline{\text{PDRST}}^2$					
Input Low Voltage, V_{INL}			0.4	V	$DV_{\text{DD}} = 3\text{ V}$
			0.8	V	$DV_{\text{DD}} = 5\text{ V}$
Input High Voltage, V_{INH}	1.8			V	$DV_{\text{DD}} = 3\text{ V}$
	2.4			V	$DV_{\text{DD}} = 5\text{ V}$
SCLK (Schmitt-Triggered Input) Hysteresis		100		mV	$DV_{\text{DD}} = 3\text{ V}$
		140		mV	$DV_{\text{DD}} = 5\text{ V}$
Input Currents		± 2		μA	$V_{\text{IN}} = DV_{\text{DD}}$ or GND
Input Capacitance		10		pF	All digital inputs
LOGIC OUTPUT (DOUT/RDY)					
Output High Voltage, V_{OH}^2	$DV_{\text{DD}} - 0.6$			V	$DV_{\text{DD}} = 3\text{ V}$, $I_{\text{SOURCE}} = 100\ \mu\text{A}$
	4			V	$DV_{\text{DD}} = 5\text{ V}$, $I_{\text{SOURCE}} = 200\ \mu\text{A}$
Output Low Voltage, V_{OL}^2			0.4	V	$DV_{\text{DD}} = 3\text{ V}$, $I_{\text{SINK}} = 100\ \mu\text{A}$
			0.4	V	$DV_{\text{DD}} = 5\text{ V}$, $I_{\text{SINK}} = 1.6\text{ mA}$
Floating-State Leakage Current		± 2		μA	
Floating-State Output Capacitance		10		pF	
Data Output Coding		Offset binary			
POWER REQUIREMENTS ³					
Power Supply Voltage					
AV_{DD} to GND	2.7		5.25	V	
DV_{DD} to GND	2.7		5.25	V	
Power Supply Currents					
I_{DD} Current		115		μA	Gain = 1, $AV_{\text{DD}} = 3\text{ V}$
		130	160	μA	Gain = 1, $AV_{\text{DD}} = 5\text{ V}$
		330		μA	Gain = 128, $AV_{\text{DD}} = 3\text{ V}$
		420	500	μA	Gain = 128, $AV_{\text{DD}} = 5\text{ V}$
I_{DD} (Power-Down/Reset Mode)		10		μA	

¹ Temperature range is -40°C to $+105^\circ\text{C}$.

² This specification is not production tested but is supported by characterization data at initial product release.

³ Digital inputs are equal to DV_{DD} or GND.

TIMING CHARACTERISTICS

$AV_{DD} = 2.7\text{ V to }5.25\text{ V}$, $DV_{DD} = 2.7\text{ V to }5.25\text{ V}$, $GND = 0\text{ V}$, Input Logic 0 = 0 V, Input Logic 1 = DV_{DD} , unless otherwise noted.

Table 3.

Parameter ¹	Limit at T_{MIN} , T_{MAX}	Unit	Test Conditions/Comments
Read ²			
t_1	100	ns min	SCLK high pulse width
t_2	100	ns min	SCLK low pulse width
t_3^3	0	ns min	SCLK active edge to data valid delay ⁴
	60	ns max	$DV_{DD} = 4.75\text{ V to }5.25\text{ V}$
	80	ns max	$DV_{DD} = 2.7\text{ V to }3.6\text{ V}$
t_4	10	ns min	SCLK inactive edge to $\overline{DOUT/RDY}$ high
	130	ns max	
Reset			
t_5	100	ns min	\overline{PDRST} low pulse width
t_6^5	120	ms typ	FILTER/GAIN change to data valid delay
	300	ms typ	Update rate = 16.7 Hz Update rate = 10 Hz

¹ Sample tested during initial release to ensure compliance. All input signals are specified with $t_R = t_F = 5\text{ ns}$ (10% to 90% of DV_{DD}) and timed from a voltage level of 1.6 V.

² See Figure 3.

³ The values of t_3 are measured using the load circuit of Figure 2 and are defined as the time required for the output to cross the V_{OL} or V_{OH} limits.

⁴ SCLK active edge is falling edge of SCLK.

⁵ The \overline{PDRST} high to data valid delay is typically 1 ms longer than t_6 because the internal oscillator requires time to power up and settle.

Circuit and Timing Diagrams

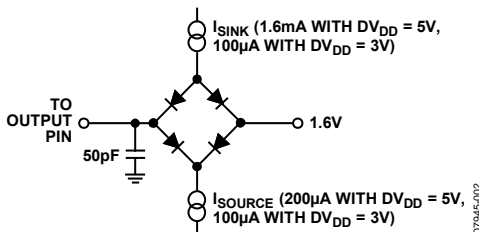

Figure 2. Load Circuit for Timing Characterization

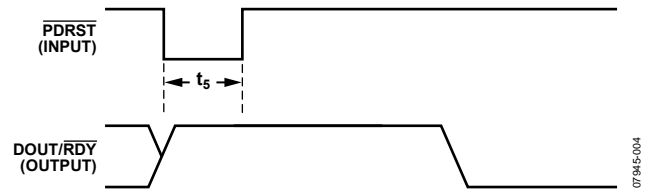

Figure 4. Resetting the AD7780

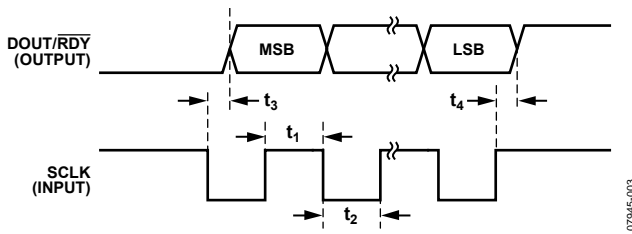

Figure 3. Read Cycle Timing Diagram

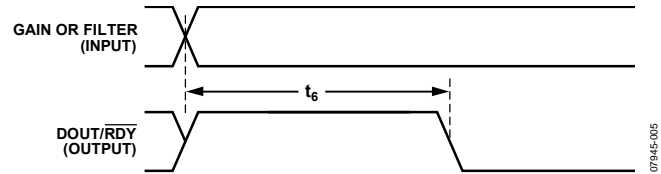

Figure 5. Changing Gain or Filter Option

ABSOLUTE MAXIMUM RATINGS

$T_A = 25^\circ\text{C}$, unless otherwise noted.

Table 4.

Parameter	Rating
AV_{DD} to GND	-0.3 V to +7 V
DV_{DD} to GND	-0.3 V to +7 V
Analog Input Voltage to GND	-0.3 V to $AV_{DD} + 0.3$ V
Reference Input Voltage to GND	-0.3 V to $AV_{DD} + 0.3$ V
Digital Input Voltage to GND	-0.3 V to $DV_{DD} + 0.3$ V
Digital Output Voltage to GND	-0.3 V to $DV_{DD} + 0.3$ V
AIN/Digital Input Current	10 mA
Operating Temperature Range	-40°C to $+105^\circ\text{C}$
Storage Temperature Range	-65°C to $+150^\circ\text{C}$
Maximum Junction Temperature	150°C
Lead Temperature, Soldering Reflow	260°C

Stresses above those listed under Absolute Maximum Ratings may cause permanent damage to the device. This is a stress rating only; functional operation of the device at these or any other conditions above those indicated in the operational section of this specification is not implied. Exposure to absolute maximum rating conditions for extended periods may affect device reliability.

THERMAL RESISTANCE

θ_{JA} is specified for the worst-case conditions, that is, a device soldered in a circuit board for surface-mount packages.

Table 5.

Package Type	θ_{JA}	θ_{JC}	Unit
14-Lead SOIC	104.5	42.9	$^\circ\text{C}/\text{W}$
16-Lead TSSOP	150.4	27.6	$^\circ\text{C}/\text{W}$

ESD CAUTION



ESD (electrostatic discharge) sensitive device.

Charged devices and circuit boards can discharge without detection. Although this product features patented or proprietary protection circuitry, damage may occur on devices subjected to high energy ESD. Therefore, proper ESD precautions should be taken to avoid performance degradation or loss of functionality.

PIN CONFIGURATIONS AND FUNCTION DESCRIPTIONS

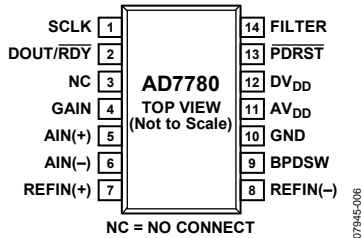

Figure 6. SOIC Pin Configuration

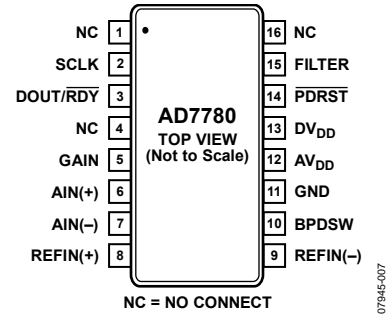

Figure 7. TSSOP Pin Configuration

Table 6. Pin Function Descriptions

Pin No.		Mnemonic	Description
SOIC	TSSOP		
1	2	SCLK	Serial Clock Input. This serial clock input is for data transfers from the ADC. The SCLK pin has a Schmitt-triggered input. The serial clock can be active only when transferring data from the AD7780. The data from the AD7780 can be read as a continuous 32-bit word. Alternatively, SCLK can be noncontinuous during the data transfer, with the information being transmitted from the ADC in smaller data batches.
2	3	DOUT/ $\overline{\text{RDY}}$	Serial Data Output/Data Ready Output. DOUT/ $\overline{\text{RDY}}$ serves a dual purpose: as a data ready pin, going low to indicate the completion of a conversion, and as a serial data output pin to access the data register of the ADC. Eight status bits accompany each data read (see Figure 22). The DOUT/ $\overline{\text{RDY}}$ falling edge can be used as an interrupt to a processor, indicating that new data is available. If the data is not read after the conversion, the pin goes high before the next update occurs. The serial interface is reset each time that a conversion is available. Therefore, the user must ensure that any conversions being transmitted are completed before the next conversion is available.
3	1, 4, 16	NC	No Connect. This pin can be left floating.
4	5	GAIN	Gain Select Pin. When GAIN is low, the gain is set to 128. When GAIN is high, the gain is set to 1.
5	6	AIN(+)	Analog Input. AIN(+) is the positive terminal of the differential analog input pair, AIN(+)/AIN(-).
6	7	AIN(-)	Analog Input. AIN(-) is the negative terminal of the differential analog input pair, AIN(+)/AIN(-).
7	8	REFIN(+)	Positive Reference Input. An external reference can be applied between REFIN(+) and REFIN(-). The nominal reference voltage (REFIN(+) – REFIN(-)) is 5 V, but the part can function with a reference of 0.5 V to AV _{DD} .
8	9	REFIN(-)	Negative Reference Input.
9	10	BPDSW	Bridge Power-Down Switch to GND. When $\overline{\text{PDRST}}$ is high, the bridge power-down switch is closed. When $\overline{\text{PDRST}}$ is low, the switch is opened.
10	11	GND	Ground Reference Point.
11	12	AV _{DD}	Supply Voltage, 2.7 V to 5.25 V.
12	13	DV _{DD}	Digital Interface Supply Voltage. The logic levels for the serial interface pins and the digital control pins are related to this supply, which is between 2.7 V and 5.25 V. The DV _{DD} voltage is independent of the voltage on AV _{DD} ; therefore, AV _{DD} can equal 5 V with DV _{DD} at 3 V or vice versa.
13	14	$\overline{\text{PDRST}}$	Power-Down/Reset. When this pin is low, the ADC is placed in power-down mode, and the low-side power switch is opened. All the logic on the chip is reset, and the DOUT/ $\overline{\text{RDY}}$ pin is tristated. When $\overline{\text{PDRST}}$ is high, the ADC is taken out of power-down mode. The on-chip clock powers up and settles, and the ADC continuously converts. In addition, the low-side power switch is closed. The internal clock requires approximately 1 ms to power up.
14	15	FILTER	Filter Select. When FILTER is low, the fast settling filter is selected. The update rate is set to 16.7 Hz, which gives a filter settling time of 120 ms. When FILTER is high, the high rejection filter is selected. The update rate is set to 10 Hz, which gives a filter settling time of 300 ms. With this filter, the stop-band (higher than f _{ADC}) attenuation is better than -45 dB.

TYPICAL PERFORMANCE CHARACTERISTICS

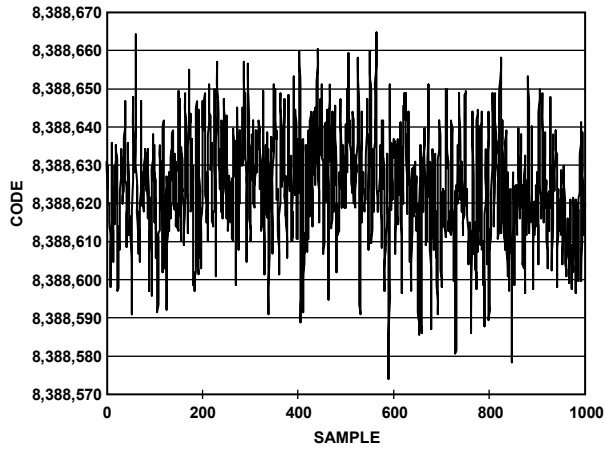

Figure 8. Noise ($V_{REF} = AV_{DD}$, Update Rate = 16.7 Hz, Gain = 128)

07945-008

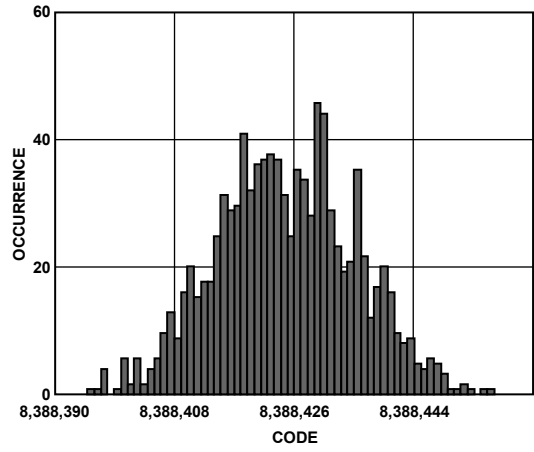

Figure 11. Noise Distribution Histogram ($V_{REF} = AV_{DD}$, Update Rate = 10 Hz, Gain = 128)

07945-011

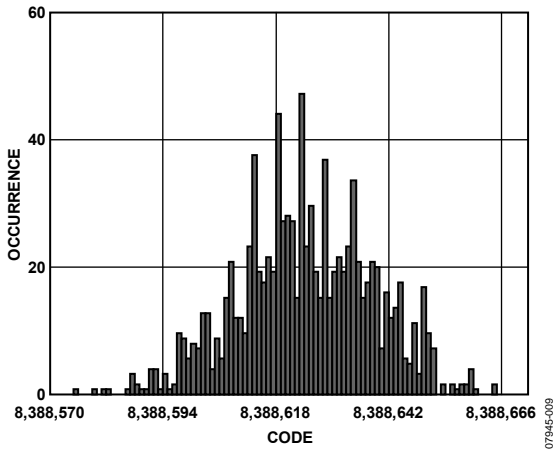

Figure 9. Noise Distribution Histogram ($V_{REF} = AV_{DD}$, Update Rate = 16.7 Hz, Gain = 128)

07945-009

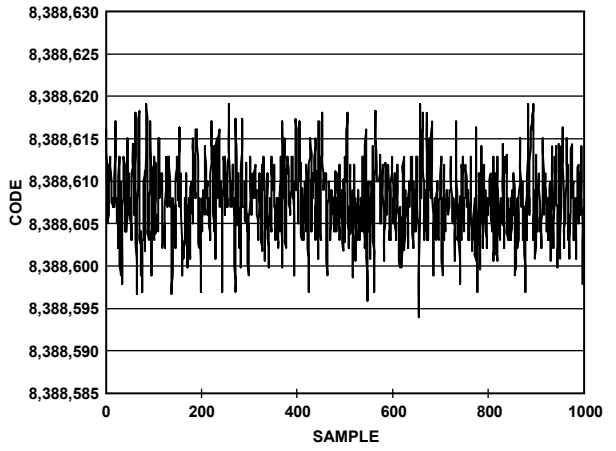

Figure 12. Noise ($V_{REF} = AV_{DD}$, Update Rate = 16.7 Hz, Gain = 1)

07945-012

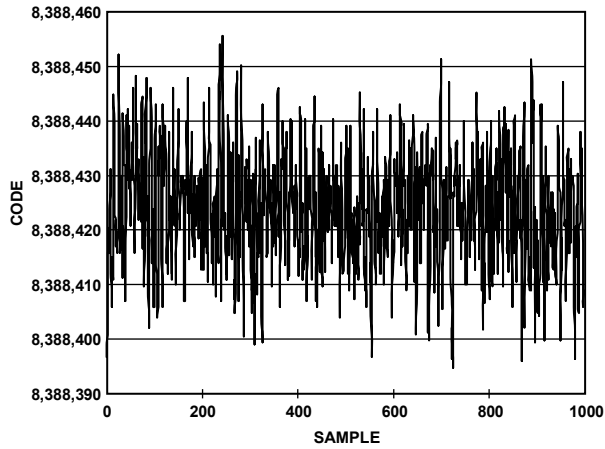

Figure 10. Noise ($V_{REF} = AV_{DD}$, Update Rate = 10 Hz, Gain = 128)

07945-010

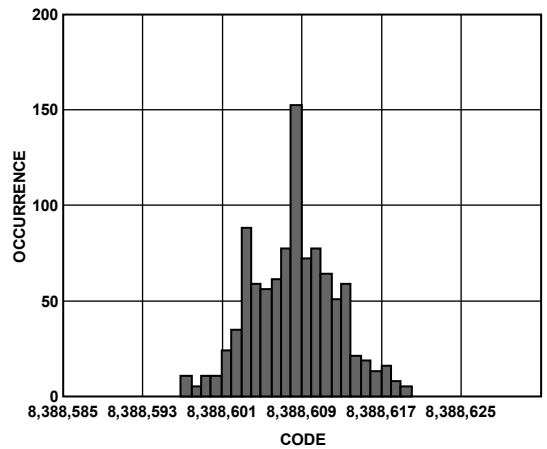

Figure 13. Noise Distribution Histogram ($V_{REF} = AV_{DD}$, Update Rate = 16.7 Hz, Gain = 1)

07945-013

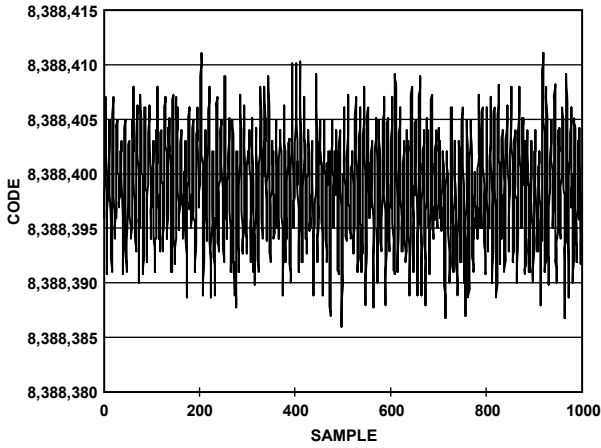

Figure 14. Noise ($V_{REF} = AV_{DD}$, Update Rate = 10 Hz, Gain = 1)

07945-014

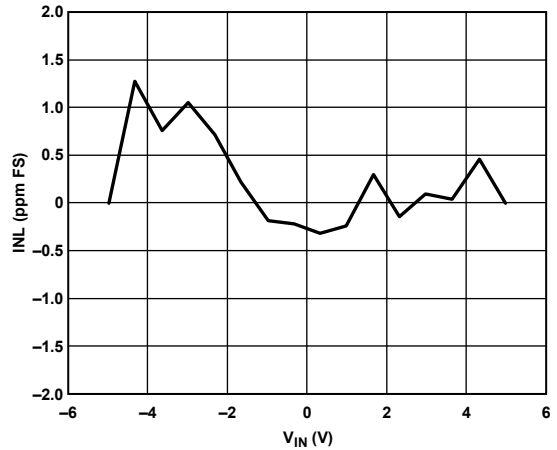

Figure 17. Integral Nonlinearity ($V_{REF} = AV_{DD}$, Gain = 1)

07945-017

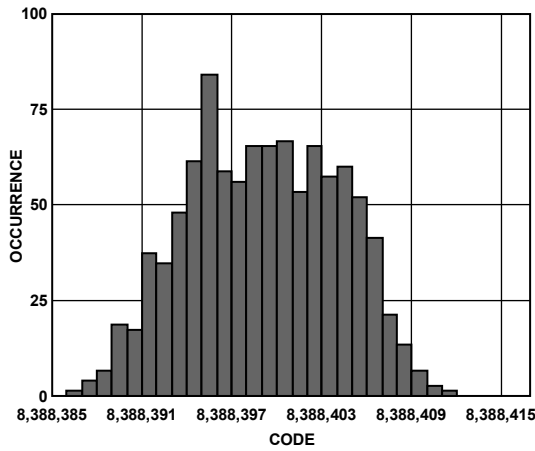

Figure 15. Noise Distribution Histogram ($V_{REF} = AV_{DD}$, Update Rate = 10 Hz, Gain = 1)

07945-015

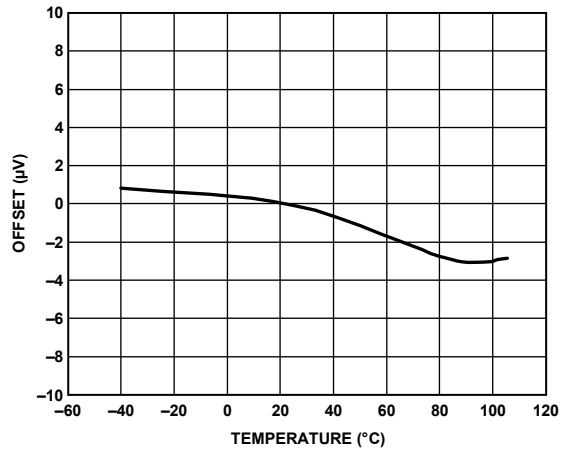

Figure 18. Offset vs. Temperature (Gain = 128)

07945-018

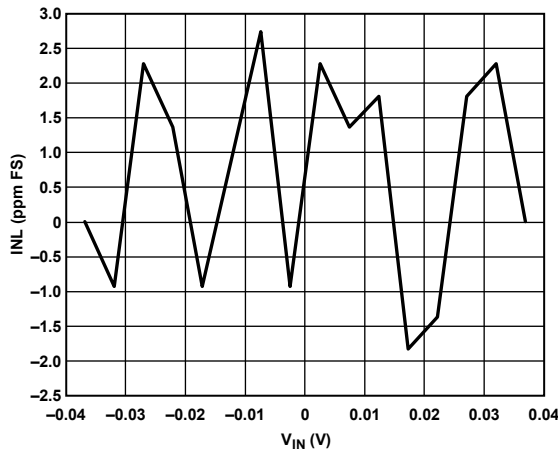

Figure 16. Integral Nonlinearity ($V_{REF} = AV_{DD}$, Gain = 128)

07945-016

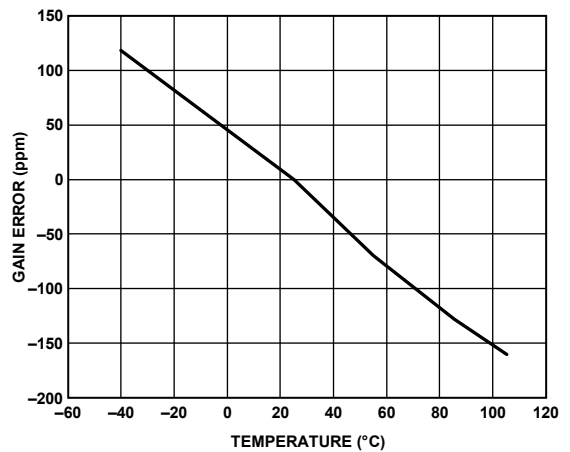

Figure 19. Gain Error vs. Temperature (Gain = 128)

07945-019

OUTPUT NOISE AND RESOLUTION

Table 7 and Table 8 show the rms noise of the AD7780 for the two output data rates and gain settings when 3 V and 5 V references are used. These numbers are typical and are generated using a differential input voltage of 0 V. The corresponding peak-to-peak (p-p) resolution is also listed. The p-p resolution represents the resolution for which there is no code flicker.

Table 7. RMS Noise and Peak-to-Peak Resolution when $A_{V_{DD}} = 3\text{ V}$ and $V_{REF} = 3\text{ V}$

Parameter	Gain = 128		Gain = 1	
	Update Rate	10 Hz	16.7 Hz	10 Hz
RMS Noise	44 nV	65 nV	2.4 μV	2.7 μV
P-P Resolution	17.6	17.1	18.8	18.7

Table 8. RMS Noise and Peak-to-Peak Resolution when $A_{V_{DD}} = 5\text{ V}$ and $V_{REF} = 5\text{ V}$

Parameter	Gain = 128		Gain = 1	
	Update Rate	10 Hz	16.7 Hz	10 Hz
RMS Noise	49 nV	69 nV	3 μV	2.7 μV
P-P Resolution	18.2	17.7	19.3	19.4

THEORY OF OPERATION

The AD7780 is a low power ADC that incorporates a precision 24-bit, Σ - Δ modulator; a PGA; and an on-chip digital filter intended for measuring wide dynamic range, low frequency signals. The part provides a complete front-end solution for bridge sensor applications such as weigh scales and pressure sensors.

The device has an internal clock and one buffered differential input. It offers a choice of two update rates (10 Hz or 16.7 Hz) and two gain settings (1 or 128). These functions are controlled using dedicated pins, which makes the interface easy to configure. A 2-wire interface simplifies data retrieval from the AD7780.

FILTER, DATA RATE, AND SETTLING TIME

The AD7780 has two filter options. When the FILTER pin is low, the 16.7 Hz filter is selected; when the FILTER pin is high, the 10 Hz filter is selected. When the polarity of FILTER is changed, the AD7780 modulator and filter are reset immediately. DOUT/RDY is set high, and the ADC then begins conversions using the selected filter response. The first conversion requires the complete settling time of the filter. Subsequent conversions occur at the selected update rate. The settling time of the 10 Hz filter is 300 ms (three conversion cycles), and the settling time of the 16.7 Hz filter is 120 ms (two conversion cycles).

When a step change occurs on the analog input, the AD7780 requires several conversion cycles to generate a valid conversion. If the step change occurs synchronous to the conversion period, the settling time of the AD7780 must be allowed to generate a valid conversion. If the step change occurs asynchronous to the end of a conversion, an extra conversion must be allowed to generate a valid conversion. The data register is updated with all the conversions, but, for an accurate result, the user must allow for the required time.

Figure 20 and Figure 21 show the filter response for each filter. The 10 Hz filter provides greater than -45 dB of rejection in the stop band. The only external filtering required on the analog inputs is a simple R-C filter to provide rejection at multiples of the master clock. A 1 k Ω resistor in series with each analog input, a 0.01 μ F capacitor from each input to GND, and a 0.1 μ F capacitor from AIN(+) to AIN(-) are recommended.

When the filter is changed, DOUT/RDY goes high and remains high until the appropriate settling time for that filter elapses (see Figure 5). Therefore, the user should complete any read operations before changing the filter. Otherwise, 1s are read back from the AD7780 because the DOUT/RDY pin is set high following the filter change.

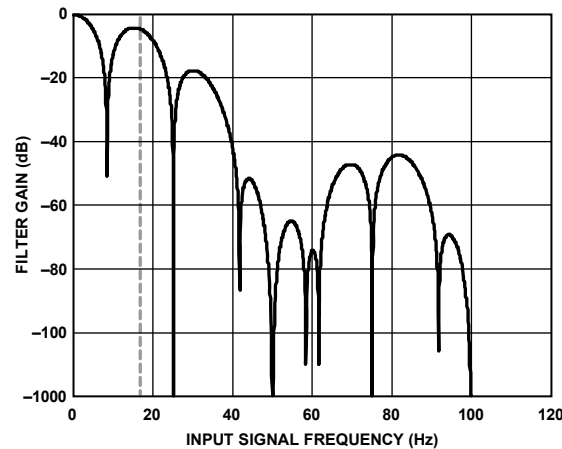

Figure 20. Filter Profile with Update Rate = 16.7 Hz (FILTER = 0)

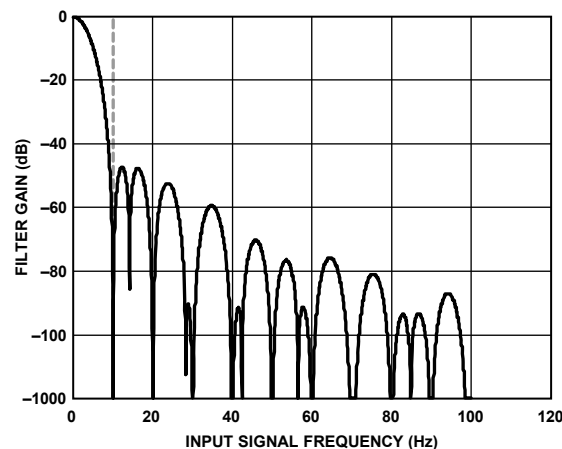

Figure 21. Filter Profile with Update Rate = 10 Hz (FILTER = 1)

GAIN

The AD7780 has two gain options: gain = 1 and gain = 128. When the GAIN pin is low, the gain is set to 128; when the GAIN pin is high, the gain is set to 1. The acceptable analog input range is $\pm V_{REF}/\text{gain}$. Thus, with $V_{REF} = 5\text{ V}$, the input range is $\pm 5\text{ V}$ when the GAIN pin is high and $\pm 39\text{ mV}$ when the GAIN pin is low.

When the polarity of the GAIN pin is changed, the AD7780 modulator and filter are reset immediately. $\overline{\text{DOUT/RDY}}$ is set high, and the ADC then begins conversions. $\overline{\text{DOUT/RDY}}$ remains high until the appropriate settling time for the filter elapses (see Figure 5). Therefore, the user should complete any read operations before changing the gain. Otherwise, 1s are read back from the AD7780 because the $\overline{\text{DOUT/RDY}}$ pin is set high following the gain change. The total settling time of the selected filter is required to generate the first conversion after the gain change; subsequent conversions occur at the selected update rate.

POWER-DOWN/RESET (PDRST)

The $\overline{\text{PDRST}}$ pin functions as a power-down pin and a reset pin. When $\overline{\text{PDRST}}$ is taken low, the AD7780 is powered down. The entire ADC is powered down (including the on-chip clock), the low-side power switch is opened, and the $\overline{\text{DOUT/RDY}}$ pin is tristated. The circuitry and serial interface are also reset, which resets the logic, the digital filter, and the analog modulator. $\overline{\text{PDRST}}$ must be held low for 100 ns minimum to initiate the reset function (see Figure 4).

When $\overline{\text{PDRST}}$ is taken high, the AD7780 is taken out of power-down mode. When the on-chip clock has powered up (1 ms, typically), the modulator begins sampling the analog input. The low-side power switch is closed, and the $\overline{\text{DOUT/RDY}}$ pin becomes active.

A reset is automatically performed on power-up.

ANALOG INPUT CHANNEL

The AD7780 has one differential analog input channel. The input channel feeds into a high impedance input stage of the amplifier. Therefore, the input can tolerate significant source impedances and is tailored for direct connection to external resistive-type sensors such as strain gages.

The absolute input voltage range is restricted to a range between $\text{GND} + 300\text{ mV}$ and $\text{AV}_{DD} - 1.1\text{ V}$. Care must be taken in setting up the common-mode voltage to avoid exceeding these limits. Otherwise, there is degradation in linearity and noise performance.

The low noise in-amp means that signals of small amplitude can be amplified within the AD7780, while maintaining excellent noise performance. The amplifier can be configured to have a gain of 128 or 1, using the GAIN pin. The analog input range is equal to $\pm V_{REF}/\text{gain}$. The common-mode voltage $(\text{AIN}(+) + \text{AIN}(-))/2$ must be $\geq 0.5\text{ V}$.

BIPOLAR CONFIGURATION

The AD7780 accepts a bipolar input range. A bipolar input range does not imply that the part can tolerate negative voltages with respect to system GND. Signals on the $\text{AIN}(+)$ input are referenced to the voltage on the $\text{AIN}(-)$ input. For example, if $\text{AIN}(-)$ is 2.5 V, the analog input range on the $\text{AIN}(+)$ input is 2.46 V to 2.54 V for a gain of 128.

DATA OUTPUT CODING

The AD7780 uses offset binary coding. Thus, a negative full-scale voltage results in a code of 000...000, a zero differential input voltage results in a code of 100...000, and a positive full-scale input voltage results in a code of 111...111.

The output code for any analog input voltage can be represented as

$$\text{Code} = 2^{N-1} \times [(\text{AIN} \times \text{Gain} / V_{REF}) + 1]$$

where:

AIN is the analog input voltage.

Gain is 1 or 128.

$N = 24$.

REFERENCE

The AD7780 has a fully differential input capability for the channel. The common-mode range for these differential inputs is GND to AV_{DD} . The reference input is unbuffered; therefore, excessive R-C source impedances introduce gain errors. The reference voltage of $\text{REFIN}(\text{REFIN}(+) - \text{REFIN}(-))$ is AV_{DD} nominal, but the AD7780 is functional with reference voltages of 0.5 V to AV_{DD} . In applications where the excitation (voltage or current) for the transducer on the analog input also drives the reference voltage for the part, the effect of the low frequency noise in the excitation source is removed because the application is ratiometric. If the AD7780 is used in a nonratiometric application, a low noise reference should be used.

Recommended 2.5 V reference voltage sources for the AD7780 include the [ADR381](#) and [ADR391](#), which are low noise, low power references. These references have low output impedances and are, therefore, tolerant to decoupling capacitors on $\text{REFIN}(+)$ without introducing gain errors in the system. Deriving the reference input voltage across an external resistor means that the reference input sees a significant external source impedance. External decoupling on the REFIN pins is not recommended in this type of circuit configuration.

BRIDGE POWER-DOWN SWITCH

The bridge power-down switch (BPDSW) is useful in battery-powered applications where the optimization of system power consumption is essential. A 350 Ω load cell typically consumes 15 mA when excited with a 5 V power supply. To minimize the current consumption, the load cell is disconnected when it is not being used. The bridge power-down switch can be included in series with the load cell. When $\overline{\text{PDRST}}$ is high, the bridge power-down switch is closed, and the load cell measures the strain. When $\overline{\text{PDRST}}$ is low, the bridge power-down switch is opened so no current flows through the load cell. Therefore, the current consumption of the system is minimized. The bridge power-down switch has an on resistance of 9 Ω maximum. The switch is capable of withstanding 30 mA of continuous current.

DIGITAL INTERFACE

The serial interface of the AD7780 consists of two signals: SCLK and DOUT/RDY. SCLK is the serial clock input for the device, and data transfers occur with respect to the SCLK signal. The DOUT/RDY pin is dual purpose: it functions as a data ready pin and as a data output pin. DOUT/RDY goes low when a new data-word is available in the output register. A 32-bit word is placed on the DOUT/RDY pin when sufficient SCLK pulses are applied. This word consists of a 24-bit conversion result and eight status bits. Figure 22 shows the status bits, and Table 9 describes the status bits and their functions.

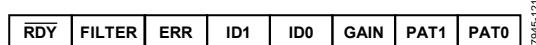

Figure 22. Status Bits

Table 9. Status Bit Functions

Bit Name	Description															
RDY	Ready bit. 0: a conversion is available.															
FILTER	Filter bit. 1: 10 Hz filter is selected 0: 16.7 Hz filter is selected.															
ERR	Error bit. 1: an error occurred during conversion. (An error occurs when the analog input is outside the range.)															
ID1, ID0	ID bits.															
	<table border="1"> <thead> <tr> <th>ID1</th> <th>ID0</th> <th>Function</th> </tr> </thead> <tbody> <tr> <td>0</td> <td>1</td> <td>Indicates the ID number for the AD7780</td> </tr> </tbody> </table>	ID1	ID0	Function	0	1	Indicates the ID number for the AD7780									
ID1	ID0	Function														
0	1	Indicates the ID number for the AD7780														
GAIN	Gain bit. 1: gain = 1. 0: gain = 128.															
PAT1, PAT0	Status pattern bits. When the user reads data from the AD7780, a pattern check can be performed.															
	<table border="1"> <thead> <tr> <th>PAT1</th> <th>PAT0</th> <th>Function</th> </tr> </thead> <tbody> <tr> <td>0</td> <td>1</td> <td>Indicates that the serial transfer from the ADC was performed correctly (default).</td> </tr> <tr> <td>0</td> <td>0</td> <td>Indicates that the serial transfer from the ADC was not performed correctly.</td> </tr> <tr> <td>1</td> <td>0</td> <td>Indicates that the serial transfer from the ADC was not performed correctly.</td> </tr> <tr> <td>1</td> <td>1</td> <td>Indicates that the serial transfer from the ADC was not performed correctly.</td> </tr> </tbody> </table>	PAT1	PAT0	Function	0	1	Indicates that the serial transfer from the ADC was performed correctly (default).	0	0	Indicates that the serial transfer from the ADC was not performed correctly.	1	0	Indicates that the serial transfer from the ADC was not performed correctly.	1	1	Indicates that the serial transfer from the ADC was not performed correctly.
PAT1	PAT0	Function														
0	1	Indicates that the serial transfer from the ADC was performed correctly (default).														
0	0	Indicates that the serial transfer from the ADC was not performed correctly.														
1	0	Indicates that the serial transfer from the ADC was not performed correctly.														
1	1	Indicates that the serial transfer from the ADC was not performed correctly.														

DOUT/RDY is reset high when the conversion has been read. If the conversion is not read, DOUT/RDY goes high prior to the data register update to indicate when not to read from the device. This ensures that a read operation is not attempted while the register is being updated. Each conversion can be read only once. The data register is updated for every conversion. When a conversion is complete, the serial interface is reset, and the new conversion is placed in the data register. Therefore, the user must ensure that the complete word is read before the next conversion is complete.

When $\overline{\text{PDRST}}$ is low, the DOUT/RDY pin is tristated. When $\overline{\text{PDRST}}$ is taken high, the internal clock requires approximately 1 ms to power up. Following power-up, the ADC continuously converts. The first conversion requires the total settling time (see Figure 4). DOUT/RDY goes high when $\overline{\text{PDRST}}$ is taken high and returns low only when a conversion is available. The ADC then converts continuously, and subsequent conversions are available at the selected update rate. Figure 3 shows the timing for a read operation from the AD7780.

When the filter response is changed (using FILTER) or the gain is changed (using GAIN), the modulator and filter are reset immediately (see Figure 5). DOUT/RDY is set high. The ADC then begins conversions using the selected filter response/gain setting. DOUT/RDY remains high until the appropriate settling time for that filter has elapsed. Therefore, the user should complete any read operations before changing the gain or update rate. Otherwise, 1s are read back from the AD7780 because the DOUT/RDY pin is set high following the gain/filter change.

APPLICATIONS INFORMATION

The AD7780 provides a low cost, high resolution analog-to-digital function. Because the analog-to-digital function is provided by a Σ - Δ architecture, the parts are more immune to noisy environments, making them ideal for use in sensor measurement and industrial and process control applications.

WEIGH SCALES

Figure 23 shows the AD7780 being used in a weigh scale application. The load cell is arranged in a bridge network and gives a differential output voltage between its OUT+ and OUT- terminals. Assuming a 5 V excitation voltage, the full-scale output range from the transducer is 10 mV when the sensitivity is 2 mV/V. The excitation voltage for the bridge can be used to directly provide the reference for the ADC because the reference input range includes the supply voltage.

A second advantage of using the AD7780 in transducer-based applications is that the bridge power-down switch (BPDSW) can be fully utilized in low power applications. The bridge power-down switch is connected in series with the low side of the bridge. In normal operation, the switch is closed and measurements can be taken. In applications where power is of concern, the AD7780 can be placed in power-down mode, significantly reducing the power consumed in the application. In addition, the bridge power-down switch is opened while in power-down mode, thus avoiding unnecessary power consumption by the front-end transducer. When the part is taken out of power-down mode and the bridge power-down switch is closed, the user should ensure that the front-end circuitry is fully settled before attempting a read from the AD7780.

The load cell has an offset or tare associated with it. This tare is the main component of the system offset (load cell + ADC) and is similar in magnitude to the full-scale signal from the load cell. For this reason, calibrating the offset and gain of the AD7780 alone is not sufficient for optimum accuracy; a system calibration that calibrates the offset and gain of the ADC, plus the load cell, is required. A microprocessor can be used to perform the calibrations. The offset (the conversion result from the AD7780 when

no load is applied to the load cell) and the full-scale error (the conversion result from the ADC when the maximum load is applied to the load cell) must be determined. Subsequent conversions from the AD7780 are then corrected, using the offset and gain coefficients that were calculated from these calibrations.

PERFORMANCE IN A WEIGH SCALE SYSTEM

If the load cell has a sensitivity of 2 mV/V and a 5 V excitation voltage is used, the full-scale signal from the load cell is 10 mV. When the AD7780 operates with a 10 Hz output data rate and the gain is set to 128, the device has a p-p resolution of 18.2 bits when the reference is equal to 5 V. Postprocessing the data from the AD7780 using a microprocessor increases the p-p resolution. For example, an average by 4 in the microprocessor increases the accuracy by 2 bits. The noise-free counts is equal to the following:

$$\text{Noise-Free Counts} = (2^{\text{Effective Bits}})(FS_{LC}/FS_{ADC})$$

where:

$\text{Effective Bits} = 18.2 \text{ bits} + 2 \text{ bits}$ (due to post-processing in the microprocessor).

FS_{LC} is the full-scale signal from the load cell (10 mV).

FS_{ADC} is the full-scale input range when gain = 128 and $V_{REF} = 5 \text{ V}$ (78 mV).

The noise-free counts are equal to the following:

$$(2^{18.2+2})(10 \text{ mV}/78 \text{ mV}) = 154,422$$

This example shows that with a 5 V supply, 154,422 noise-free counts can be achieved with the AD7780.

EMI RECOMMENDATIONS

For simplicity, the EMI filters are not included in Figure 23. However, an R-C antialiasing filter should be included on each analog input. This filter is needed because the on-chip digital filter does not provide any rejection around the master clock or multiples of the master clock. Suitable values are a 1 k Ω resistor in series with each analog input, a 0.1 μF capacitor from AIN(+) to AIN(-), and 0.01 μF capacitors from AIN(+)/AIN(-) to GND.

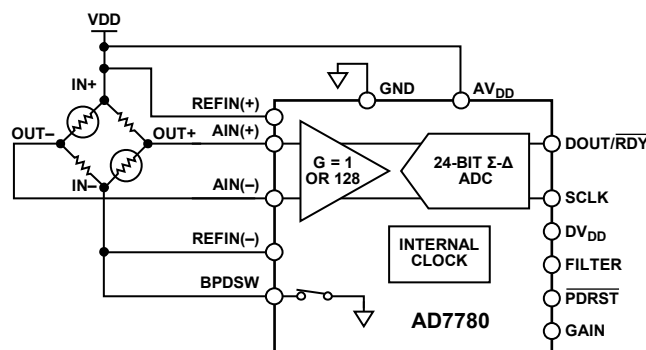

Figure 23. Weigh Scales Using the AD7780

07945-022

GROUNDING AND LAYOUT

Because the analog input and reference input of the ADC are differential, most of the voltages in the analog modulator are common-mode voltages. The excellent common-mode rejection of the part removes common-mode noise on these inputs. The digital filter provides rejection of broadband noise on the power supply, except at integer multiples of the modulator sampling frequency. The digital filter also removes noise from the analog and reference inputs, provided that these noise sources do not saturate the analog modulator. As a result, the AD7780 is more immune to noise interference than conventional high resolution converters. However, because the resolution of the AD7780 is so high, and the noise levels from the AD7780 are so low, care must be taken with regard to grounding and layout.

The printed circuit board that houses the AD7780 should be designed such that the analog and digital sections are separated and confined to certain areas of the board. A minimum etch technique is generally best for ground planes because it gives the best shielding.

It is recommended that the GND pin of the AD7780 be tied to the AGND plane of the system. In any layout, pay attention to the flow of currents in the system and ensure that the return paths for all currents are as close as possible to the paths that the currents took to reach their destinations. Avoid forcing digital currents to flow through the AGND sections of the layout.

The ground plane of the AD7780 should be allowed to run under the AD7780 to prevent noise coupling. The power supply lines to the AD7780 should use as wide a trace as possible to provide low impedance paths and reduce the effects of glitches on the power supply line. Fast switching signals such as clocks should be shielded with digital ground to avoid radiating noise to other sections of the board, and clock signals should never be run near the analog inputs. Avoid crossover of digital and analog signals. Traces on opposite sides of the board should run at right angles to each other. This reduces the effects of feedthrough through the board. A microstrip technique is by far the best, but it is not always possible with a double-sided board. In this technique, the component side of the board is dedicated to ground planes, and the signals are placed on the solder side.

Good decoupling is important when using high resolution ADCs. AV_{DD} should be decoupled with 10 μF tantalum capacitors in parallel with 0.1 μF capacitors to GND. DV_{DD} should be decoupled with 10 μF tantalum capacitors in parallel with 0.1 μF capacitors to GND, with the system's AGND to DGND connection kept close to the AD7780. To achieve the best results from these decoupling components, place them as close as possible to the device, ideally right up against the device. All logic chips should be decoupled with 0.1 μF ceramic capacitors to DGND.

OUTLINE DIMENSIONS

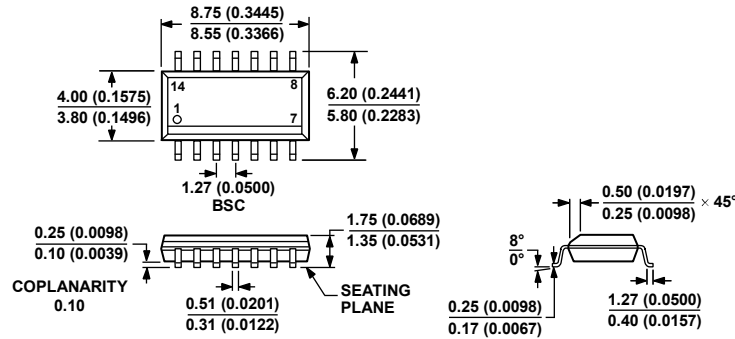

COMPLIANT TO JEDEC STANDARDS MS-012-AB
 CONTROLLING DIMENSIONS ARE IN MILLIMETERS; INCH DIMENSIONS
 (IN PARENTHESES) ARE ROUNDED-OFF MILLIMETER EQUIVALENTS FOR
 REFERENCE ONLY AND ARE NOT APPROPRIATE FOR USE IN DESIGN.

Figure 24. 14-Lead Standard Small Outline Package [SOIC_N]
 Narrow Body
 (R-14)

Dimensions shown in millimeters and (inches)

060606-A

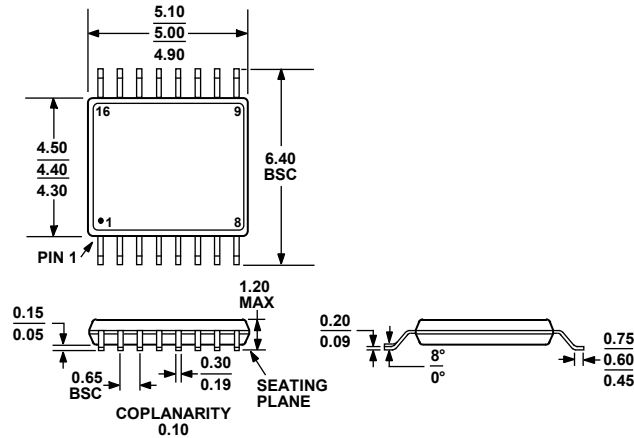

COMPLIANT TO JEDEC STANDARDS MO-153-AB

Figure 25. 16-Lead Thin Shrink Small Outline Package [TSSOP]
 (RU-16)

Dimensions shown in millimeters

ORDERING GUIDE

Model	Temperature Range	Package Description	Package Option
AD7780BRZ ¹	-40°C to +105°C	14-Lead SOIC_N	R-14
AD7780BRZ-REEL ¹	-40°C to +105°C	14-Lead SOIC_N	R-14
AD7780BRUZ ¹	-40°C to +105°C	16-Lead TSSOP	RU-16
AD7780BRUZ-REEL ¹	-40°C to +105°C	16-Lead TSSOP	RU-16

¹ Z = RoHS Compliant Part.