

Applications

- IEEE802.11b DSSS WLAN
- IEEE802.11g OFDM WLAN
- Access Points, PCMCIA, PC cards

Features

- Pin for pin compatible to SiGe's SE2521A34 but providing 2 dB extra output power
- Dual Mode IEEE802.11b & IEEE802.11g
- All RF ports matched to 50 Ω
- Integrated PA, TX Filter, DPDT T/R and Diversity switches
- Integrated Power Detector
- 23 dBm O/P Power, 802.11b, 11 Mbps, ACPR <- 35 dBc
- 18 dBm @ 2.0 %, 802.11g, 54 Mbps
- Single supply voltage: 3.3 V ± 10 %
- Lead free and RoHS compliant
- Small lead free plated package, 8 mm x 7 mm x 1.1 mm, MSL 3

Product Description

The SE2521A60 is a complete 802.11 b/g WLAN RF front-end module providing all the functionality of the power amplifier, power detector, T/R switch, diversity switch and associated matching. The SE2521A60 provides a complete 2.4 GHz WLAN RF solution from the output of the transceiver to the antennas in an ultra compact form factor.

Designed for ease of use, all RF ports are matched to 50 Ω to simplify PCB layout and the interface to the transceiver RFIC. The SE2521A60 also includes a transmitter power detector with 20 dB of dynamic range and a digital enable control for transmitter power ramp on/off control. The power ramp rise/fall time is 1 μsec typical.

The device also provides a notch filter from 3.2-3.3 GHz prior to the input of the power amplifier.

The SE2521A60 is footprint compatible to SiGe's SE2521A34 and can be placed directly into existing SE2521A34 designs easily providing higher output power solutions

Ordering Information

Part No.	Package	Remark
SE2521A60	24 pin LGA	Samples
SE2521A60-R	24 pin LGA	Tape and Reel
SE2521A60-EK1	N/A	Evaluation kit

Functional Block Diagram

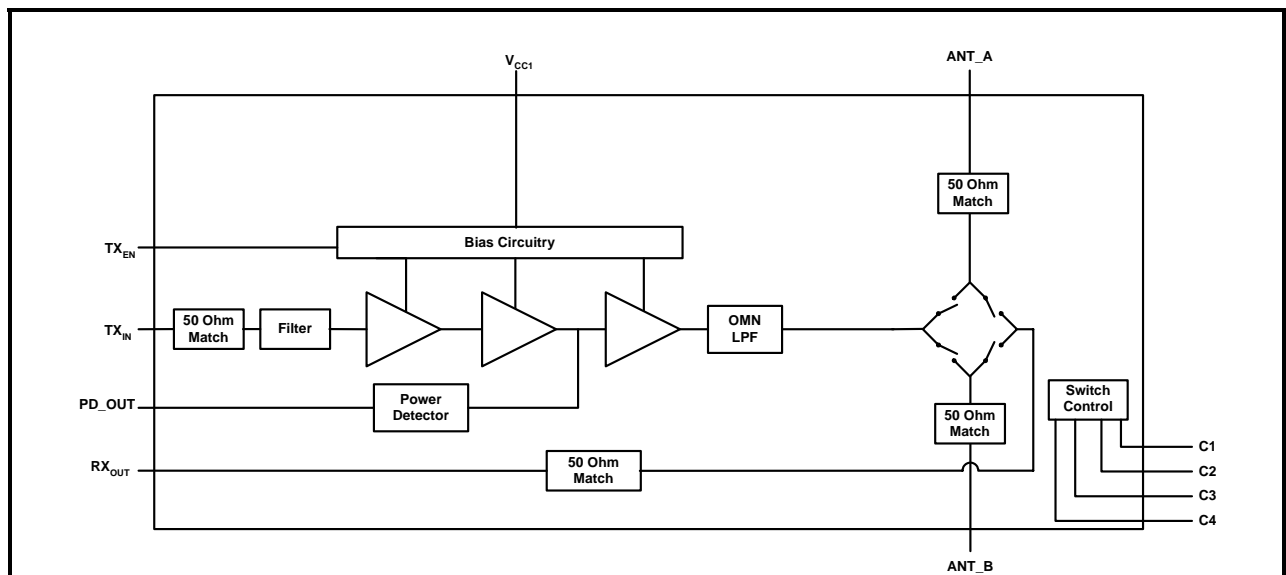

Figure 1: Functional Block Diagram

Pin Out Diagram

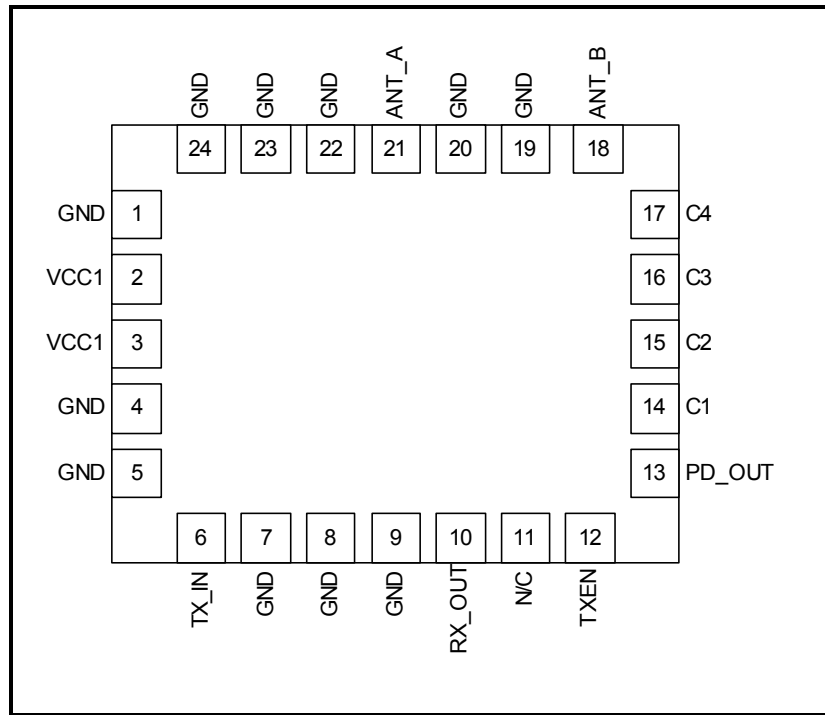

Figure 2: SE2521A60 Pin Out (Top View Through Package)

Pin Out Description

Pin No.	Name	Description
1	GND	Ground
2	VCC1	+3.3 V DC
3	VCC1	+3.3 V DC
4,5	GND	Ground
6	TX_IN	Transmit Input
7,8,9	GND	Ground
10	RX_OUT	Receive Output
11	N/C	No Connect
12	TXEN	Transmit Enable
13	PD_OUT	Power Detector
14	C1	Control 1 Input
15	C2	Control 2 Input
16	C3	Control 3 Input
17	C4	Control 4 Input
18	ANT_B	Antenna B (50 ohm)
19,20	GND	Ground
21	ANT_A	Antenna A (50 ohm)
22,23,24	GND	Ground

Absolute Maximum Ratings

These are stress ratings only. Exposure to stresses beyond these maximum ratings may cause permanent damage to, or affect the reliability of the device. Avoid operating the device outside the recommended operating conditions defined below. This device is ESD sensitive. Handling and assembly of this device should be at ESD protected workstations.

Symbol	Definition	Min.	Max.	Unit
V _{CC}	Supply Voltage on V _{CC}	-0.3	4.0	V
TX _{EN}	Power Amplifier Enable	-0.3	4.0	V
TX _{RF}	RF Input Power	-	2.0	dBm
T _A	Operating Temperature Range	-20	85	°C
T _{STG}	Storage Temperature Range	-40	150	°C

Recommended Operating Conditions

Symbol	Parameter	Min.	Typ.	Max.	Unit
V _{CC}	Supply Voltage	3.0	3.3	3.6	V
T _A	Ambient Temperature	0	25	85	°C

DC Electrical Characteristics

Conditions: V_{CC} = V_{EN} = 3.3 V, T_A = 25 °C, as measured on SiGe Semiconductor's SE2521A60-EV1 evaluation board (de-embedded to device), all unused ports terminated with 50 ohms, unless otherwise noted

Symbol	Parameter	Conditions	Min.	Typ.	Max.	Unit
I _{CC-G}	Total Supply Current	P _{OUT} = 18 dBm, 54 Mbps OFDM signal, 64QAM	165	180	230	mA
		P _{OUT} = 15 dBm, 54 Mbps OFDM signal, 64QAM	110	150	215	mA
I _{CC-B}	Total Supply Current	P _{OUT} = 20 dBm, 11 Mbps CCK signal, BT = 0.45	175	205	275	mA
I _{CC-OFF}	Total Supply Current	V _{EN} = 0 V, No RF Applied, C1 = C2 = C3 = C4 = 0 V	-	2	10	μA

Logic Characteristics

Conditions: $V_{CC} = V_{EN} = 3.3\text{ V}$, $T_A = 25\text{ }^\circ\text{C}$, as measured on SiGe Semiconductor's SE2521A60-EV1 evaluation board (de-embedded to device), all unused ports terminated with 50 ohms, unless otherwise noted.

Symbol	Parameter	Conditions	Min.	Typ.	Max.	Unit
V_{ENH}	Logic High Voltage (Module On)	-	2.0	-	V_{CC}	V
V_{ENL}	Logic Low Voltage (Module Off)	-	0	-	0.5	V
I_{ENH}	Input Current Logic High Voltage	-	-1	-	200	μA
I_{ENL}	Input Current Logic Low Voltage	-	-1	-	1	μA

Switch Characteristics

Conditions: $V_{CC} = V_{EN} = 3.3\text{ V}$, $T_A = 25\text{ }^\circ\text{C}$, as measured on SiGe Semiconductor's SE2521A60-EV1 evaluation board (de-embedded to device), all unused ports terminated with 50 ohms, unless otherwise noted.

Symbol	Parameter	Conditions	Min.	Typ.	Max.	Unit
V_{CTL_ON}	Control Voltage (On State)	-	3.0	-	3.6	V
V_{CTL_OFF}	Control Voltage (OFF State)	-	0.0	-	0.2	V
SW_{ON}	Low Loss Switch Control Voltage	High State = $V_{CTL_ON} - V_{CTL_OFF}$	2.8	-	V_{CC}	V
SW_{OFF}	High Loss Switch Control Voltage	Low State = $V_{CTL_OFF} - V_{CTL_OFF}$	0	-	0.3	V
I_{CTL_ON}	Switch Control Bias Current (RF Applied)	On pin (C1,C2,C3,C4) being driven high. RF Applied	-	-	100	μA
I_{CTL_ON}	Switch Control Bias Current (No RF)	On pin (C1,C2,C3,C4) being driven high. No RF	-	-	30	μA
C_{CTL}	Control Input Capacitance	-	-	-	100	pF

Switch Control Logic Table

Switch Logic				Operational Mode			
C1	C4	C2	C3	$TX_{RF} - ANTA$	$TX_{RF} - ANTB$	$RX_{RF} - ANTA$	$RX_{RF} - ANTB$
SW_{ON}	SW_{OFF}	SW_{OFF}	SW_{OFF}	ON	OFF	OFF	OFF
SW_{OFF}	SW_{ON}	SW_{OFF}	SW_{OFF}	OFF	ON	OFF	OFF
SW_{OFF}	SW_{OFF}	SW_{ON}	SW_{OFF}	OFF	OFF	ON	OFF
SW_{OFF}	SW_{OFF}	SW_{OFF}	SW_{ON}	OFF	OFF	OFF	ON

AC Electrical Characteristics

802.11g Transmit Characteristics

Conditions: $V_{CC} = V_{EN} = 3.3\text{ V}$, $T_A = 25\text{ }^\circ\text{C}$, as measured on SiGe Semiconductor's SE2521A60-EV1 evaluation board (de-embedded to device), all unused ports terminated with 50 ohms, unless otherwise noted.

Symbol	Parameter	Condition	Min.	Typ.	Max.	Unit
F_{IN}	Frequency Range	-	2400	-	2500	MHz
$P_{802.11g}$	Output power	54 Mbps OFDM signal, 64QAM, EVM = 2.0 %	-	18	-	dBm
$P_{802.11b}$	Output power	11 Mbps CCK signal, BT = 0.45 ACPR(Adj) < -32 ACPR(Alt) < -52	-	23	-	dBm
P_{1dB}	P1dB	-	22.5	25.5	-	dBm
S_{21}	Small Signal Gain	-	25	-	33	dB
ΔS_{21}	Small Signal Gain Variation Over Band	-	-	1.0	3.0	dB
$S_{21@3.2}$	Gain @ 3.2 to 3.3 GHz	-	-	0	7	dB
2f,3f	Harmonics	$P_{out} = 19\text{ dBm}$, 2 Mbps, 802.11b CCK	-	-49	-42	dBm/MHz
IM3	3 rd Order Inter-modulation	f1 and f2 at $F_c \pm 312.5\text{ kHz}$, $P = 15\text{ dBm}$	-	-40	-33	dBc
IM5	5 th Order Inter-modulation	f1 and f2 at $F_c \pm 312.5\text{ kHz}$, $P = 15\text{ dBm}$	-	-55	-47	dBc
t_r	Rise Time	10 % to 90% of final output power level	-	0.12	0.5	μs
t_{dr}, t_{df}	Delay and rise/fall Time	50 % of V_{EN} edge and 90/10 % of final output power level	-	-	1.0	μs
S_{11}	Input Return Loss	-	4.5	6.5	-	dB
STAB	Stability	$P_{IN} \leq -2\text{ dBm}$ Load VSWR = 6:1	All non-harmonically related outputs less than -50 dBc/1MHz			

Receive Characteristics

Conditions: $V_{CC} = V_{EN} = 3.3\text{ V}$, $T_A = 25\text{ }^\circ\text{C}$, as measured on SiGe Semiconductor's SE2521A60-EV1 evaluation board (de-embedded to device), all unused ports terminated with 50 ohms, unless otherwise noted.

Symbol	Parameter	Condition	Min.	Typ.	Max.	Unit
F _{OUT}	Frequency Range	-	2400	-	2500	MHz
RX _{IL}	Insertion Loss	-	-	0.8	1.2	dB
RX _{RL}	Return Loss	-	-	-15	-10	dB
Delta Rx	Delta between Rx paths	ANT_A to RX_OUT or ANT_B to RX_OUT	-	-	0.5	dB
TR _{ISOL-2}	Rx Leakage	C1 or C4 = SWON, C2 = C3 = SWOFF, Device transmitting 15 dBm @ ANTA or ANTB, Power measured @ RX_OUT	-9	-	3	dBm
ANTR _{ISOL}	Isolation between ANT_A and ANT_B to RX_OUT	Small signal input into ANT_A or ANT_B, Device not transmitting, Power measured @ RX_OUT, C1 AND C4 = SWON, C2 and C3 = SWOFF	14	-	24	dB

Power Detector Characteristics

Conditions: $V_{CC} = V_{EN} = 3.3\text{ V}$, $T_A = 25\text{ }^\circ\text{C}$, as measured on SiGe Semiconductor's SE2521A60-EV1 evaluation board (de-embedded to device), unless otherwise noted.

Symbol	Parameter	Condition	Min.	Typ.	Max.	Unit
F _{OUT}	Frequency Range	-	2400	-	2500	MHz
PDR	Power detect range, peak power	Measured at ANT_A or ANT_B	0	-	20	dBm
PDZ _{LOAD}	DC load impedance	-	1	-	-	Mohm
PDV _{NoRF}	Output Voltage, P _{OUT} = No RF	-	0.90	-	1.02	V
PDV _{p18}	Output Voltage, P _{OUT} = 18dBm	-	0.44	-	0.66	V
PDV _{p20}	Output Voltage, P _{OUT} = 20dBm	-	0.28	-	0.51	V
LPF _{-3dB}	Power detect low pass filter -3dB corner frequency	PDZ _{LOAD} = >1 Mohm, PDZ _{LOAD} = 180 pF	270	330	400	KHz

Note: Power detector internal impedance is 2.7 KOhm

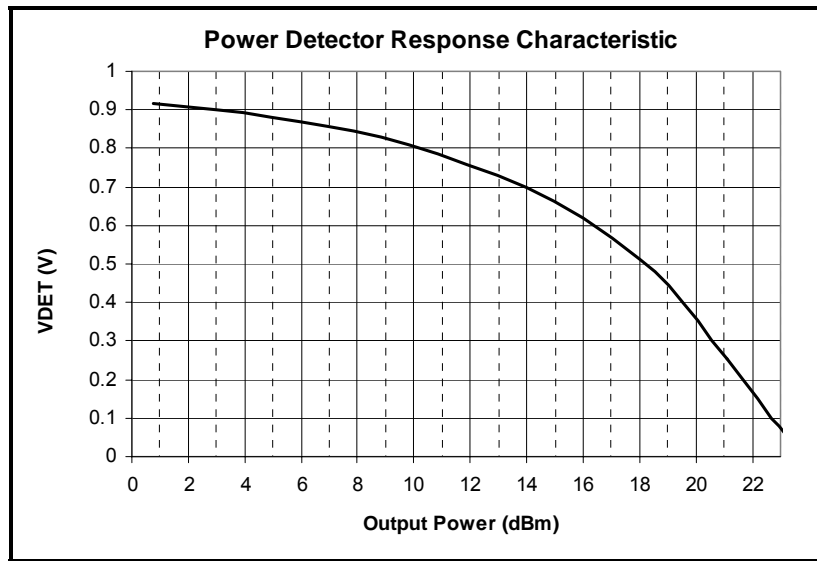

Figure 3: SE2521A60 Power Detector Performance Curve

Typical Performance Data (Ambient Temperature)

Conditions: $V_{CC} = V_{EN} = 3.3\text{ V}$, Frequency = 2450 MHz, $T_A = 25\text{ }^\circ\text{C}$, as measured on SiGe Semiconductor's SE2521A60-EV1 evaluation board, all unused ports terminated with 50 ohms, unless otherwise noted.

802.11g Typical Performance

Conditions: 54Mbps 802.11g OFDM Signal

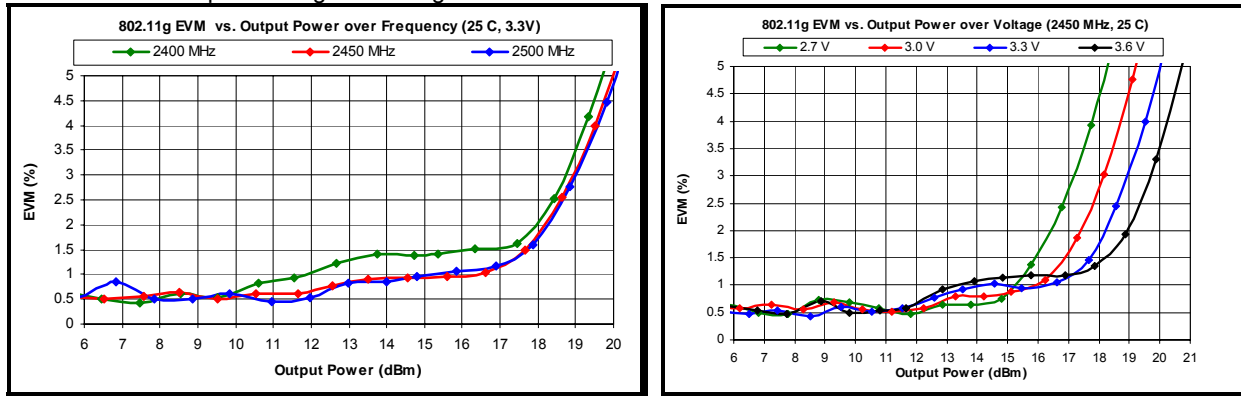

Figure 4: 802.11g Typical EVM Performance: (a) Over Frequency, (b) Over Voltage

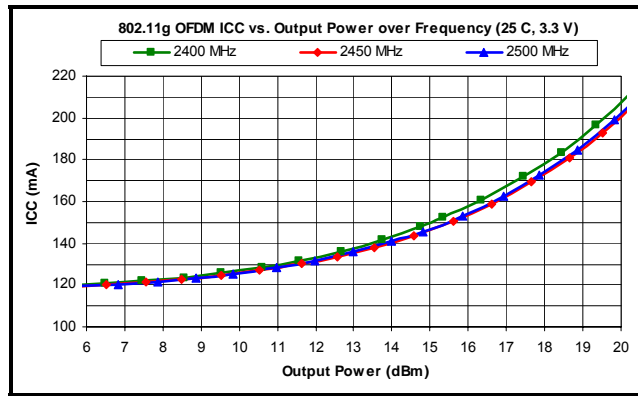

Figure 5: 802.11g Typical Current Consumption (ICC) Performance over Frequency

802.11b Typical Performance

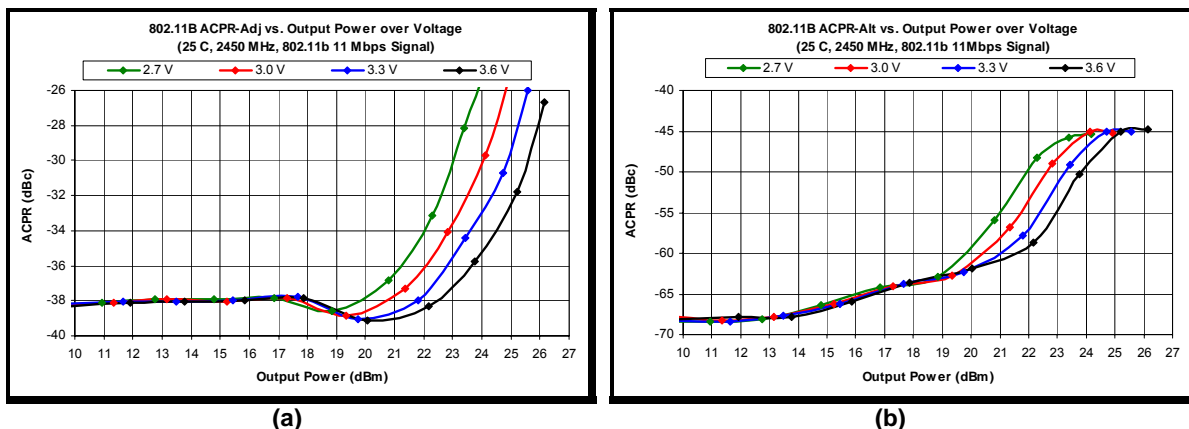

Figure 6: 802.11b Typical ACPR Performance (11 Mbps, CCK, BT = 0.45) (a) 802.11b ACPR-ADJ vs. POUT over Voltage and (b) 802.11b ACPR-ALT vs. POUT over Voltage

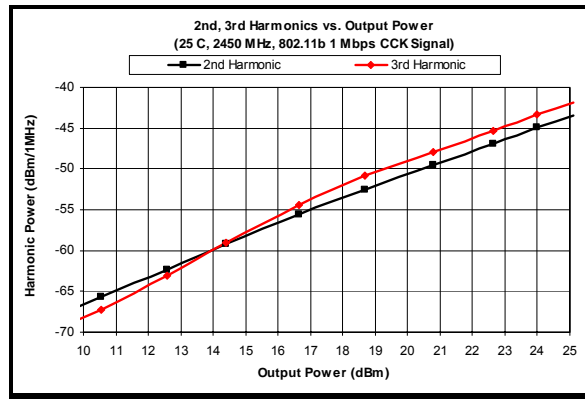
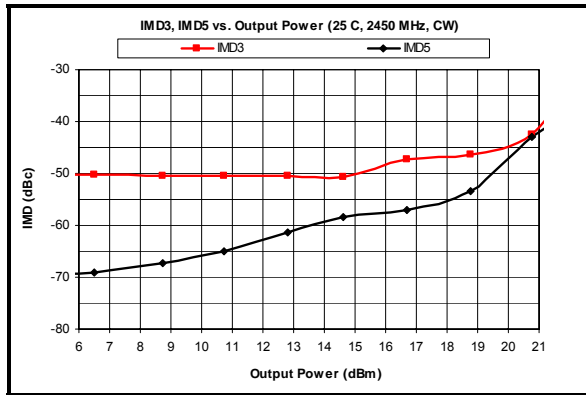
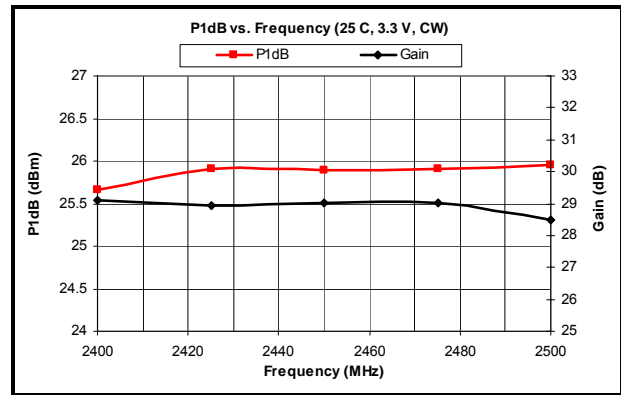

Figure 7: 802.11b Typical Harmonic Performance (1 Mbps, CCK)

CW Typical Performance



(a)



(b)

Figure 8: Typical CW Performance (a) IMD3, IMD5 vs. Output Power, (b) P1dB, Gain vs. Frequency

Detector Performance

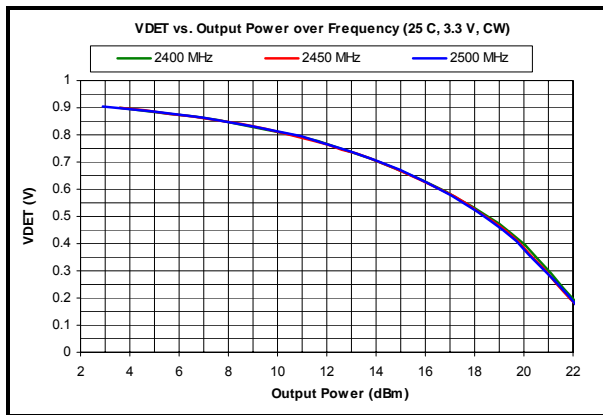

(a)

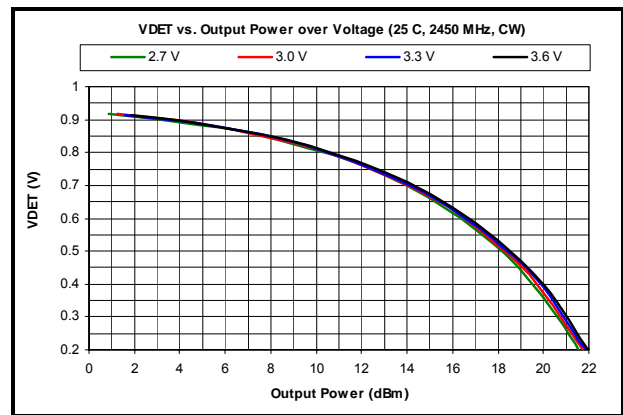

(b)

Figure 9: Typical Power Detector Response: (a) Over Frequency, (b) Over Voltage

Typical Performance Data (Over Temperature: -40 C, 25 C, 85 C)

Conditions: $V_{CC} = V_{EN} = 3.3\text{ V}$, Frequency = 2450 MHz, as measured on SiGe Semiconductor's SE2521A60-EV1 evaluation board, all unused ports terminated with 50 ohms, unless otherwise noted.

802.11g Typical Performance

Conditions: 54Mbps 802.11g OFDM Signal

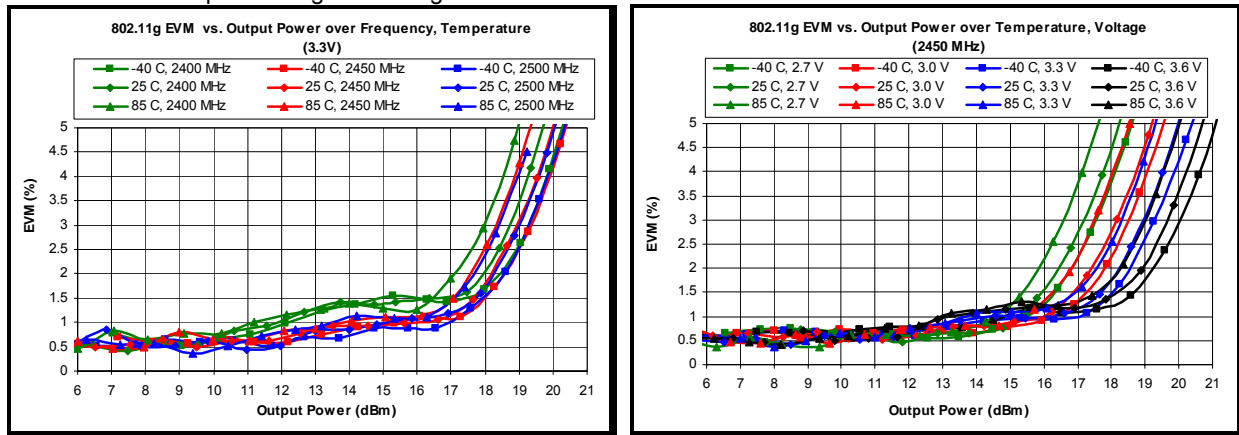

Figure 10: 802.11g Typical EVM Performance: (a) Over Frequency and Temperature, (b) Over Voltage and Temperature

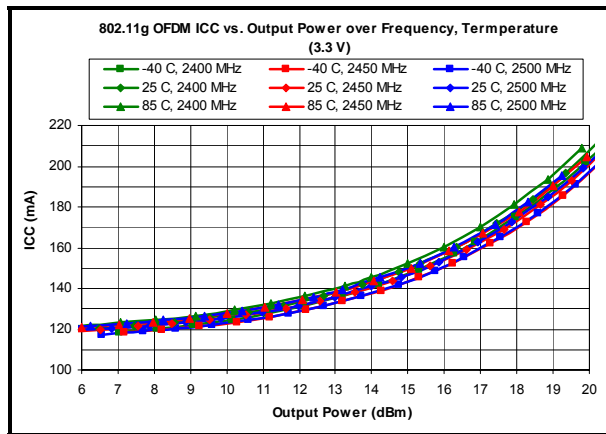

Figure 11: 802.11g Typical Current Consumption (ICC) Performance over Frequency and Temperature

802.11b Typical Performance

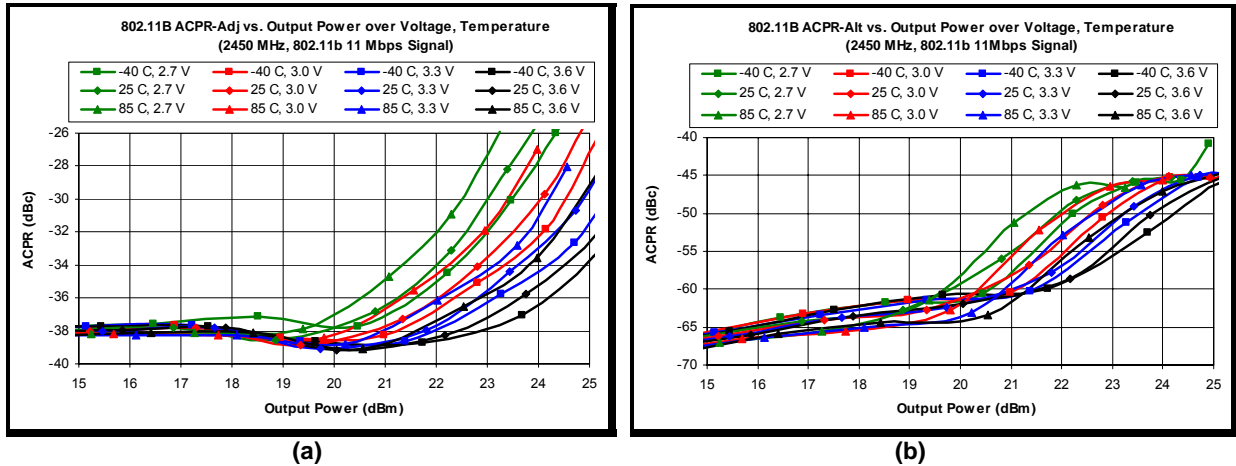

Figure 12: 802.11b Typical ACPR Performance over Voltage and Temperature (11 Mbps, CCK, BT = 0.45) (a) 802.11b ACPR-ADJ vs. POUT and (b) 802.11b ACPR-ALT vs. POUT

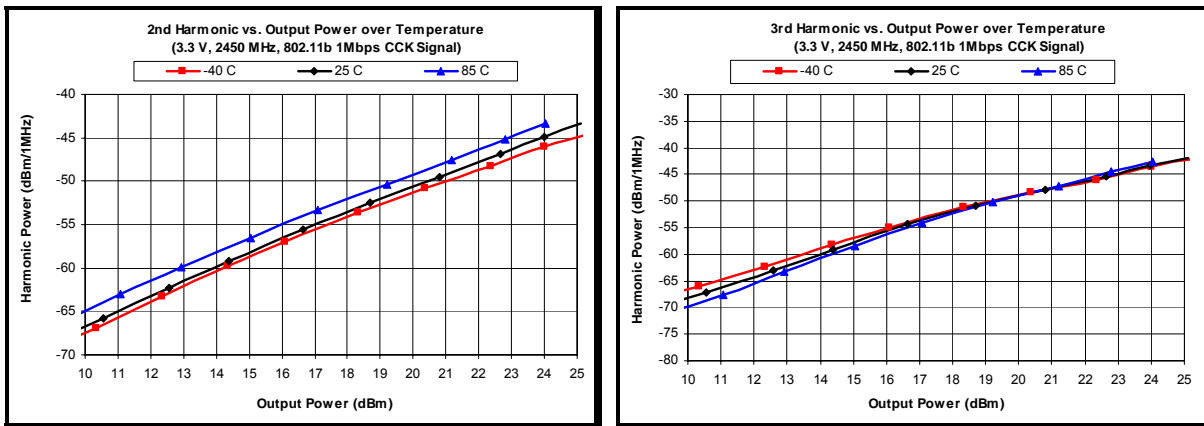

Figure 13: 802.11b Typical Harmonic Performance over Temperature (1 Mbps, CCK) (a) 2nd Harmonic (b) 3rd Harmonic

CW Typical Performance

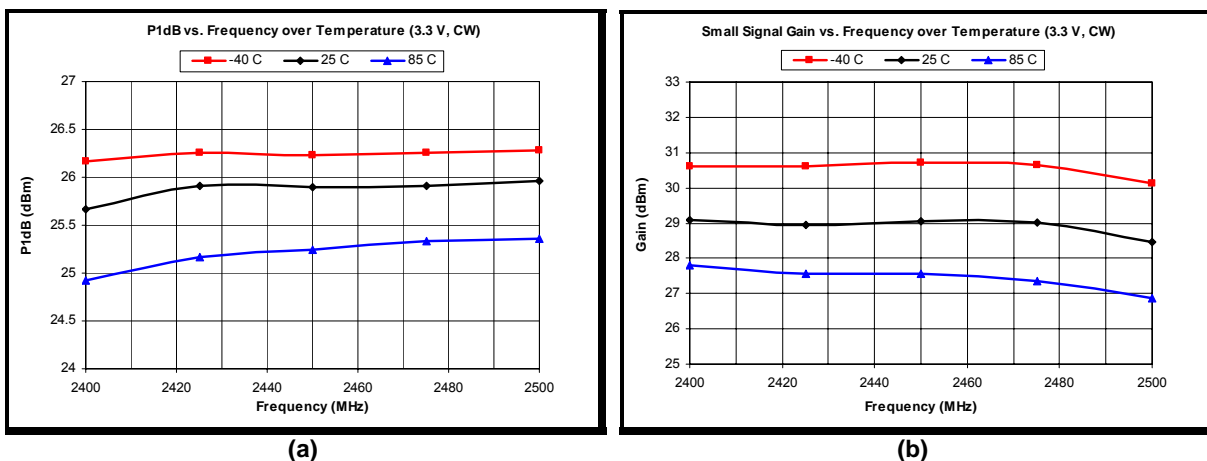

Figure 14: Typical CW Performance over Temperature (a) P1dB vs. Frequency, (b) Gain vs. Frequency

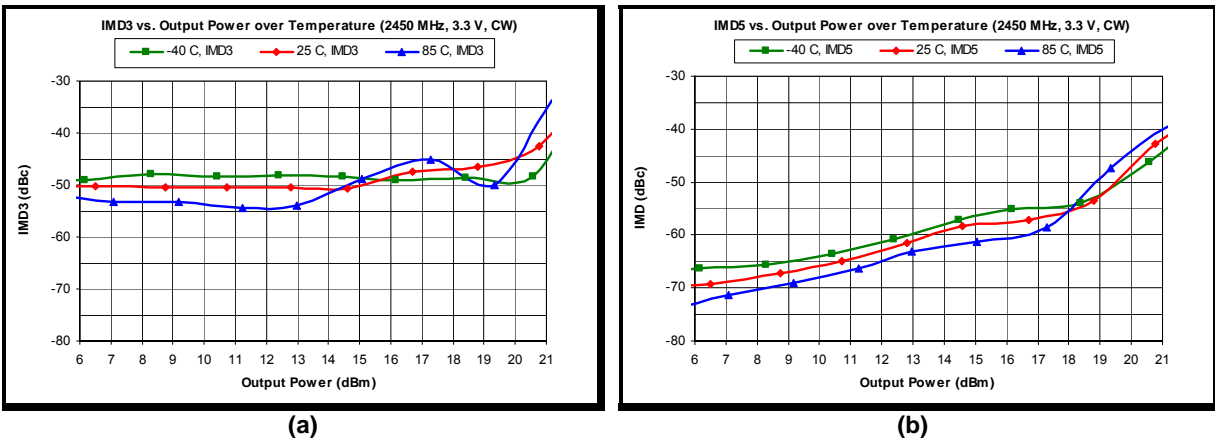

Figure 15: Typical CW Performance over Temperature (a) IMD3 vs. Output Power, (b) P1dB vs. Frequency

Typical Power Detector Performance

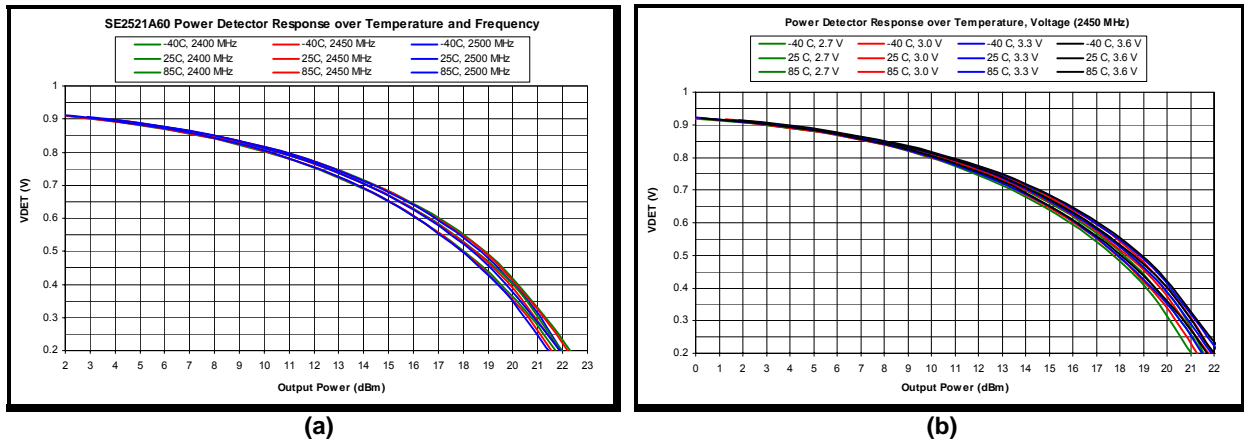

Figure 16: Typical Power Detector Response: (a) Over Frequency and Temperature, (b) Over Voltage and Temperature

Package Information

Figure 17 shows the detailed device package diagram. The pads on the SiGe RF modules are plated with gold over nickel, with a gold thickness of approx. 0.75 to 1.0 um. The modules can be reflowed onto FR4 based material using eutectic Pb based or common tin based Pb free solder pastes.

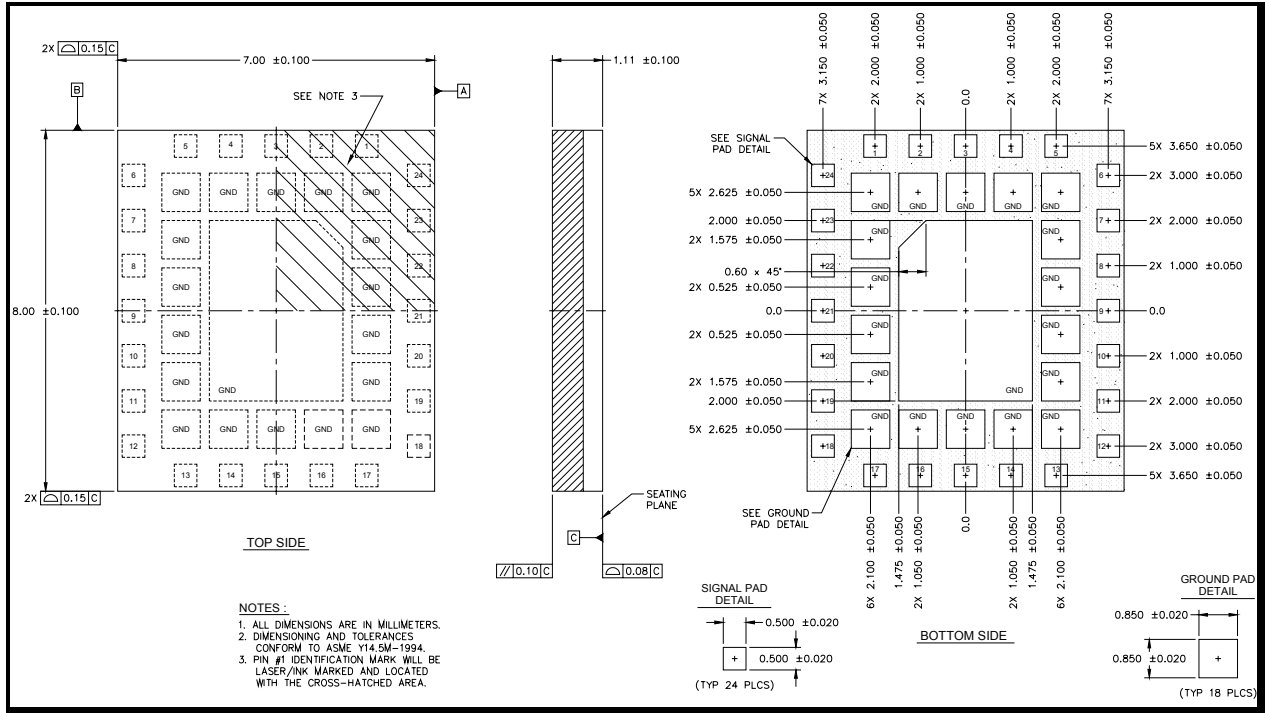

Figure 17: SE2521A60 Package Diagram

Package Handling Information

Because of its sensitivity to moisture absorption, instructions on the shipping container label must be followed regarding exposure to moisture after the container seal is broken, otherwise, problems related to moisture absorption may occur when the part is subjected to high temperature during solder assembly. The SE2521A60 is capable of withstanding a Pb free solder reflow. Care must be taken when attaching this product, whether it is done manually or in a production solder reflow environment. If the part is manually attached, precaution should be taken to insure that the device is not subjected to temperatures above its rated peak temperature for an extended period of time. For details on both attachment techniques, precautions, and handling procedures recommended by SiGe, please refer to:

- SiGe's Application Note: "Land Grid Array Module Solder Reflow & Rework Information", *Document Number 69-APP-01*.
- SiGe's Application Note: "Handling, Packing, Shipping and Use of Moisture Sensitive LGA", *Document Number 69-APP-02*.

Recommended PCB Footprint

Figure 18 shows the recommended PCB footprint for the SE2521A60.

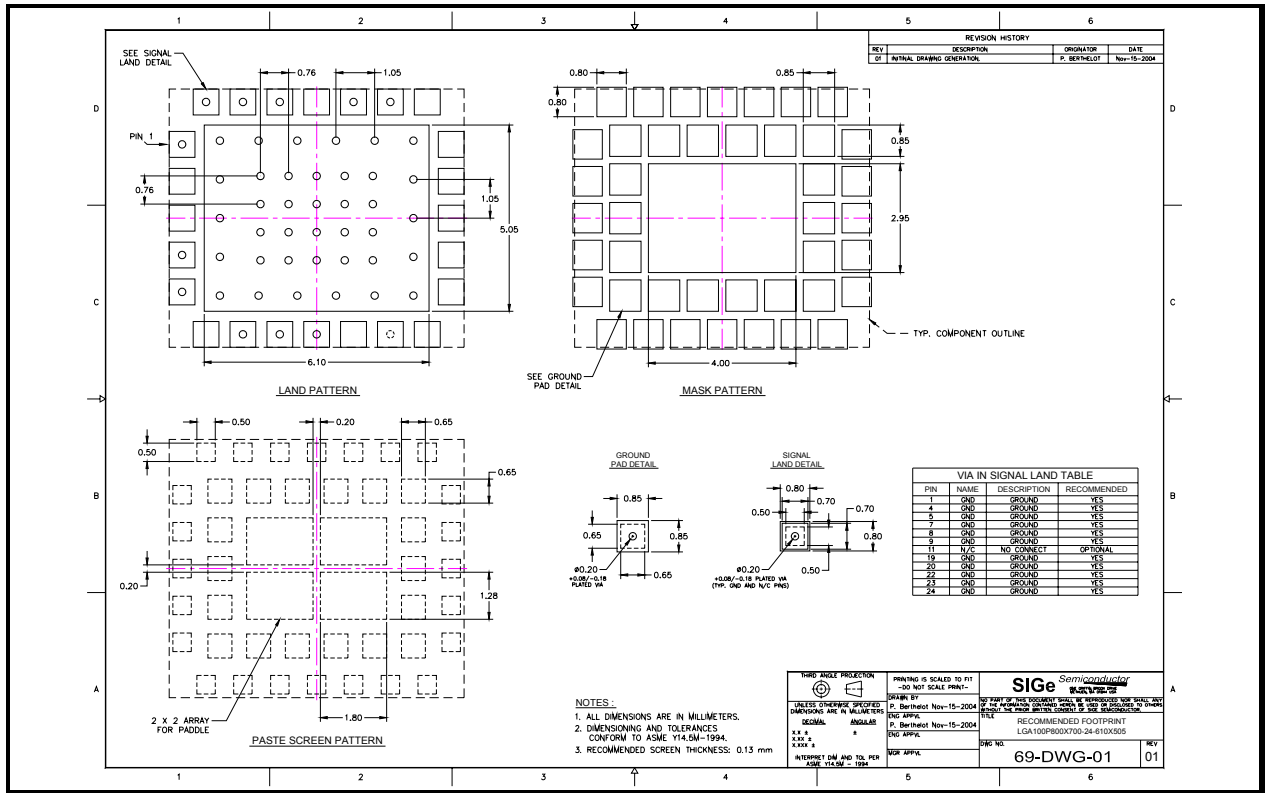

Figure 18: SE2521A60 Recommended PCB Footprint

Branding Information

The device branding is shown in Figure 19.

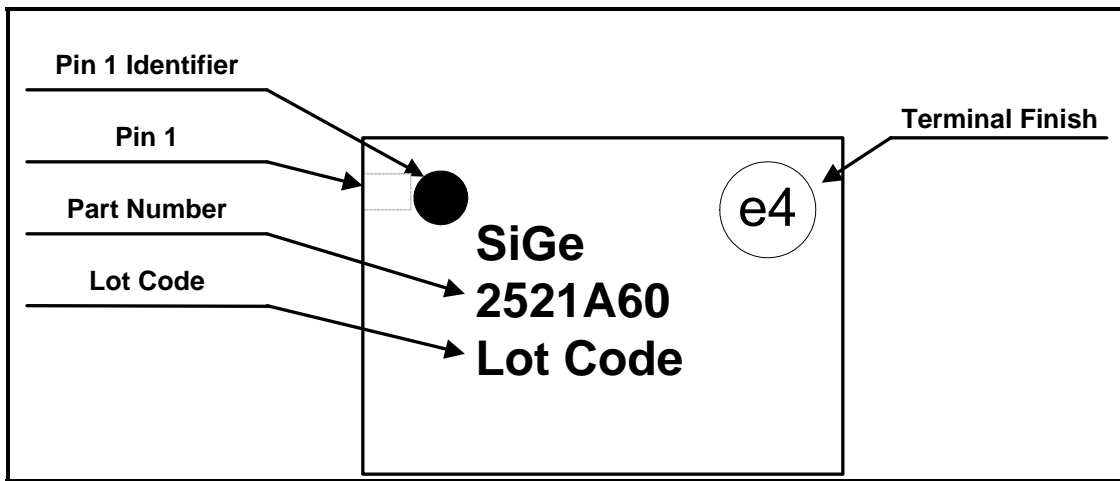

Figure 19: SE2521A60 Branding and Pin 1 Location

Tape and Reel

Production quantities of this product are shipped in a standard tape-and-reel format. Specific tape and reel dimensions and sizing is shown in Table 1 and Figure 20.

Parameter	Value
Devices Per Reel	2500
Reel Diameter	13 inches

Table 1: Tape and Reel Dimensions

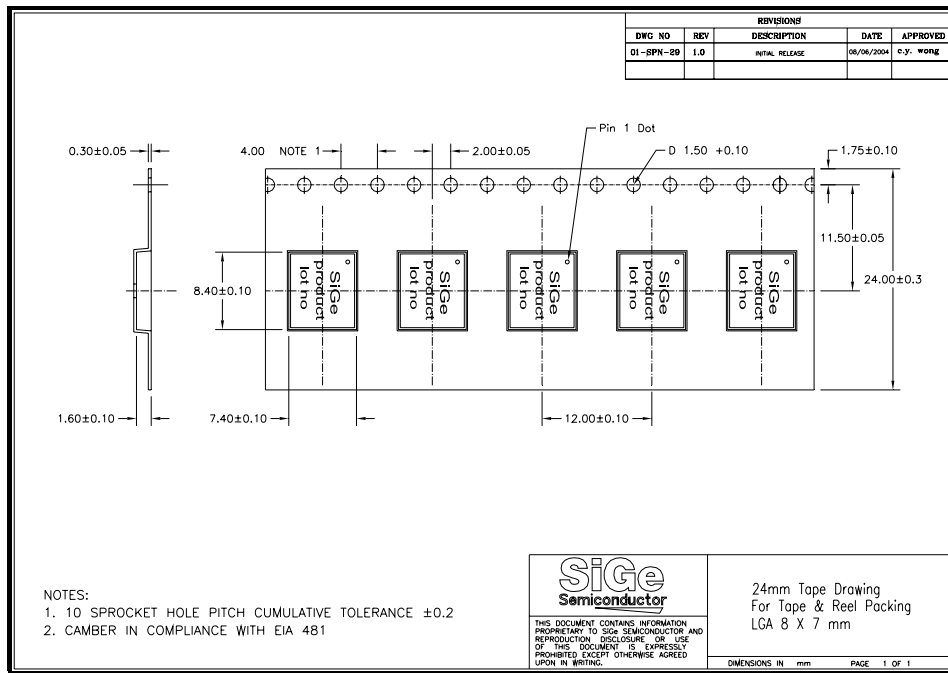

Figure 20: SE2521A60 Tape and Reel Information

<http://www.sige.com>

Email: sales@sige.com

Customer Service Locations:

North America:
1050 Morrison Drive, Suite 100
Ottawa ON K2H 8K7 Canada

Phone: +1 613 820 9244
Fax: +1 613 820 4933

Hong Kong
Phone: +852 3428 7222
Fax: +852 3579 5450

San Diego
Phone: +1 858 668 3541 (ext. 226)
Fax: +1 858 668 3546

United Kingdom
Phone: +44 1264 850754
Fax: +44 1264 852601

Product Preview

The datasheet contains information from the product concept specification. SiGe Semiconductor, Inc. reserves the right to change information at any time without notification.

Preliminary Information

The datasheet contains information from the design target specification. SiGe Semiconductor, Inc. reserves the right to change information at any time without notification.

Production testing may not include testing of all parameters.

Information furnished is believed to be accurate and reliable and is provided on an "as is" basis. SiGe Semiconductor, Inc. assumes no responsibility or liability for the direct or indirect consequences of use of such information nor for any infringement of patents or other rights of third parties, which may result from its use. No license or indemnity is granted by implication or otherwise under any patent or other intellectual property rights of SiGe Semiconductor, Inc. or third parties. Specifications mentioned in this publication are subject to change without notice. This publication supersedes and replaces all information previously supplied. SiGe Semiconductor, Inc. products are NOT authorized for use in implantation or life support applications or systems without express written approval from SiGe Semiconductor, Inc.

RangeCharger™, StreamCharger™, and PointCharger™ are trademarks owned by SiGe Semiconductor, Inc.

Copyright 2006 SiGe Semiconductor, Inc.
All Rights Reserved