

LP38513-1.8

3A Fast Response Ultra Low Dropout Linear Regulator

General Description

The LP38513 fast response ultra low dropout linear regulator operates from a +2.25V to +5.50V input supply. This ultra low dropout linear regulator responds very quickly to step changes in line or load conditions, which makes it suitable for low voltage microprocessor applications. Developed on a CMOS process, with a PMOS pass transistor, the LP38513 has low quiescent current operation that is independent of the output load current.

Ground Pin Current: Typically 12 mA at 3A load current.

Disable Mode: Typically 60 μ A quiescent current when the Enable pin is pulled low.

ERROR Flag: The ERROR Flag goes low if V_{OUT} falls more than typically 15% below the nominal value.

Precision Output Voltage: A guaranteed V_{OUT} accuracy of $\pm 2.6\%$ with T_J from 0°C to 125°C.

Features

- Conversions from 2.5V rail to 1.8V
- Stable with ceramic capacitors
- Low ground pin current
- Load regulation of 0.1% for 10 mA to 3A load current
- 60 μ A typical quiescent current in shutdown mode
- Guaranteed output current of 3A
- Available in TO220-5 and TO263-5 packages
- Guaranteed V_{OUT} accuracy of $\pm 2.6\%$ with T_J from 0°C to +125°C
- ERROR flag indicates V_{OUT} status
- Over-Temperature and Over-Current protection
- -40°C to +125°C operating T_J range

Applications

- Microprocessor power supplies
- GTL, GTL+, BTL, and SSTL bus terminators
- Power supplies for DSPs
- SCSI terminator
- Post regulators
- Battery chargers
- Other battery powered applications

Typical Application Circuit

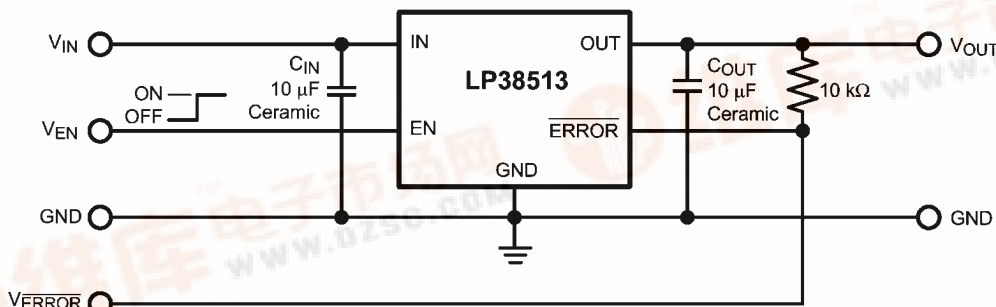

20146801

Ordering Information

[查询"LP38513"供应商](#)

TABLE 1. Package Marking and Ordering Information

Output Voltage	Order Number	Package Type	Package Marking	Supplied As:
1.8	LP38513S-1.8	TO263-5	LP38513S-1.8	Rail
	LP38513SX-1.8	TO263-5	LP38513S-1.8	Tape and Reel
	LP38513T-1.8	TO220-5	LP38513T-1.8	Rail

Connection Diagrams

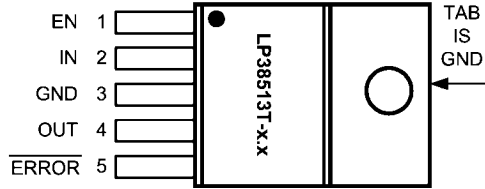

Top View
TO-220 5 Pin Package

20146803

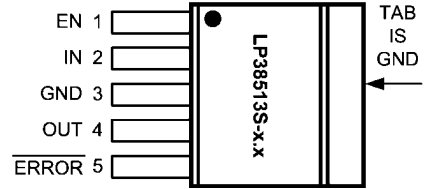

Top View
TO-263 5 Pin Package

20146804

Pin Descriptions for TO-220 and TO-263 5 Pin Packages

Pin #	TO220-5 and TO263-5	Function
1	EN	Enable. Pull high to enable the output, low to disable the output. This pin has no internal bias and must be tied to the input voltage, or actively driven.
2	IN	Input Supply Pin
3	GND	Ground
4	OUT	Regulated Output Voltage Pin
5	$\overline{\text{ERROR}}$	ERROR Flag. A high level indicates that V_{OUT} is within (tbd)% of the nominal regulated voltage.
TAB	TAB	The TO220 and TO263 TAB is used as a thermal connection to remove heat from the device to an external heatsink. The TAB is internally connected to device pin 3.

Absolute Maximum Ratings (Note 1)

If Military/Aerospace specified devices are required, please contact the National Semiconductor Sales Office/Distributors for availability and specifications.

Storage Temperature Range	-65°C to +150°C
Soldering Temperature (Note 3)	
TO-220, Wave	260°C, 10s
TO-263	235°C, 30s
ESD Rating (Note 2)	±2 kV
Power Dissipation (Note 4)	Internally Limited
Input Pin Voltage (Survival)	-0.3V to +6.0V
Enable Pin Voltage (Survival)	-0.3V to +6.0V
Output Pin Voltage (Survival)	-0.3V to +6.0V
ERROR Pin Voltage (Survival)	0.3V to +6.0V
I _{OUT} (Survival)	Internally Limited

Operating Ratings (Note 1)

Input Supply Voltage, V _{IN}	2.25V to 5.5V
Enable Input Voltage, V _{EN}	0.0V to 5.5V
ERROR Pin Voltage	0.0V to V _{IN}
Output Current (DC)	0 mA to 3A
Junction Temperature (Note 4)	-40°C to +125°C

Electrical Characteristics

Unless otherwise specified: V_{IN} = 2.5V, I_{OUT} = 10 mA, C_{IN} = 10 μF, C_{OUT} = 10 μF, V_{EN} = 2.0V. Limits in standard type are for T_J = 25°C only; limits in **boldface type** apply over the junction temperature (T_J) range of -40°C to +125°C. Minimum and Maximum limits are guaranteed through test, design, or statistical correlation. Typical values represent the most likely parametric norm at T_J = 25°C, and are provided for reference purposes only.

Symbol	Parameter	Conditions	Min	Typ	Max	Units
V _{OUT}	Output Voltage Tolerance (Note 7)	2.25V ≤ V _{IN} ≤ 5.5V 10 mA ≤ I _{OUT} ≤ 3A	-1.6 -4.1	0	+1.6 +2.6	%
		2.25V ≤ V _{IN} ≤ 5.5V 10 mA ≤ I _{OUT} ≤ 3A 0°C ≤ T _J ≤ 125°C	-2.6	0	+2.6	
ΔV _{OUT} /ΔV _{IN}	Output Voltage Line Regulation (Notes 5, 7)	2.25V ≤ V _{IN} ≤ 5.5V	-	0.03 0.06	-	%/V
ΔV _{OUT} /ΔI _{OUT}	Output Voltage Load Regulation (Notes 6, 7)	10 mA ≤ I _{OUT} ≤ 3A	-	0.10 0.20	-	%/A
V _{DO}	Dropout Voltage (Note 8)	I _{OUT} = 3A	-	-	425.	mV
I _{GND}	Ground Pin Current, Output Enabled	I _{OUT} = 10 mA ERROR pin = GND	-	10	12 15	mA
		I _{OUT} = 3A ERROR pin = GND	-	12	15 20	
	Ground Pin Current, Output Disabled	V _{EN} = 0.50V ERROR pin = GND	-	60	100 110	μA
I _{SC}	Short Circuit Current	V _{OUT} = 0V	-	5.6	-	A

Enable Input

V _{EN(TH)}	Enable On/Off Threshold	V _{EN} rising from 0.0V until the output turns On, or V _{EN} falling from ≥ 2.0V until the output turns Off	0.74 0.56	0.85	0.92 1.00	V
t _{d(OFF)}	Turn-off delay	Time from V _{EN} < V _{EN(TH)} to V _{OUT} = OFF, I _{LOAD} = 3A	-	5	-	μs
t _{d(ON)}	Turn-on delay	Time from V _{EN} > V _{EN(TH)} to V _{OUT} = ON, I _{LOAD} = 3A	-	5	-	
I _{EN}	Enable Pin Current	V _{EN} = V _{IN}	-	1	-	nA
		V _{EN} = 0V	-	-1	-	

Symbol	Parameter	Conditions	Min	Typ	Max	Units
ERROR Flag						
V_{TH}	ERROR Flag Threshold (Note 9)	V_{OUT} falling from $V_{OUT(NOM)}$ until ERROR Flag goes low	77	85	94	%
ΔV_{TH}	ERROR Flag Threshold Hysteresis (Note 9)	V_{OUT} rising from V_{TH} until ERROR Flag goes high	2.2	4	5.8	
$V_{ERROR(SAT)}$	ERROR Flag Saturation Voltage	$I_{SINK} = 1 \text{ mA}$	-	20	100	mV
I_{lk}	ERROR Flag Pin Leakage Current	$V_{ERROR} = 5.5V$	-	100	-	nA
t_d	ERROR Flag Delay time		-	1	-	μs

AC Parameters

PSRR	Ripple Rejection	$V_{IN} = 2.5V$ $f = 120\text{Hz}$	-	73	-	dB
		$V_{IN} = 2.5V$ $f = 1 \text{ kHz}$	-	70	-	
$\rho_{n(f)}$	Output Noise Density	$f = 120\text{Hz}$	-	0.8	-	$\mu\text{V}/\sqrt{\text{Hz}}$
e_n	Output Noise Voltage	$\text{BW} = 100\text{Hz} - 100\text{kHz}$ $V_{OUT} = 1.8V$	-	45	-	μV_{RMS}

Thermal Characteristics

T_{SD}	Thermal Shutdown	T_J rising	-	165	-	$^{\circ}\text{C}$
ΔT_{SD}	Thermal Shutdown Hysteresis	T_J falling from T_{SD}	-	10	-	
θ_{J-A}	Thermal Resistance Junction to Ambient	TO-220 (Note 4)	-	60	-	$^{\circ}\text{C}/\text{W}$
		TO-263 (Note 4)	-	60	-	
θ_{J-C}	Thermal Resistance Junction to Case	TO-220	-	3	-	$^{\circ}\text{C}/\text{W}$
		TO-263	-	3	-	

Note 1: Absolute Maximum Ratings indicate limits beyond which damage to the device may occur. Operating Ratings indicate conditions for which the device is intended to be functional, but does not guarantee specific performance limits. For guaranteed specifications and conditions, see the Electrical Characteristics.

Note 2: The human body model is a 100pF capacitor discharged through a 1.5k Ω resistor into each pin. Test method is per JESD22-A114.

Note 3: Refer to JEDEC J-STD-020C for surface mount device (SMD) package reflow profiles and conditions. Unless otherwise stated, the temperatures and times are for Sn-Pb (STD) only.

Note 4: Device operation must be evaluated, and derated as needed, based on ambient temperature (T_A), power dissipation (P_D), maximum allowable operating junction temperature ($T_{J(MAX)}$), and package thermal resistance (θ_{JA}).

Note 5: Output voltage line regulation is defined as the change in output voltage from the nominal value due to change in the voltage at the input.

Note 6: Output voltage load regulation is defined as the change in output voltage from the nominal value due to change in the load current at the output.

Note 7: The line and load regulation specification contains only the typical number. However, the limits for line and load regulation are included in the output voltage tolerance specification.

Note 8: Dropout voltage (V_{DO}) is typically defined as the input to output voltage differential ($V_{IN} - V_{OUT}$) where the input voltage is low enough to cause the output voltage to drop 2% from the nominal value. For the LP38513, the minimum operating voltage of 2.25V is the limiting factor and the maximum dropout voltage is defined as: $V_{DO(MAX)} = V_{IN(MIN)} - V_{OUT(MIN)}$ (i.e. $2.25V - (1.80V \times 95.9\%) = 524 \text{ mV}$)

Note 9: The ERROR Flag thresholds are specified as percentage of the nominal regulated output voltage. See Application Information.

Typical Performance Characteristics

Unless otherwise specified: $T_J = 25^\circ\text{C}$, $V_{IN} = 2.5\text{V}$, $V_{EN} = 2.0\text{V}$,

$C_{IN} = 10\mu\text{F}$, $C_{OUT} = 10\mu\text{F}$, $I_{OUT} = 10\text{mA}$.

LP38513-1.8

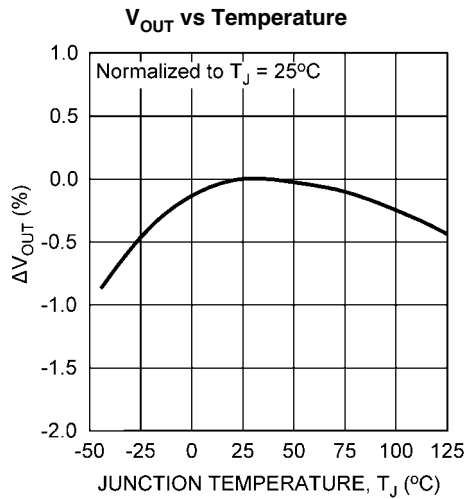

20146811

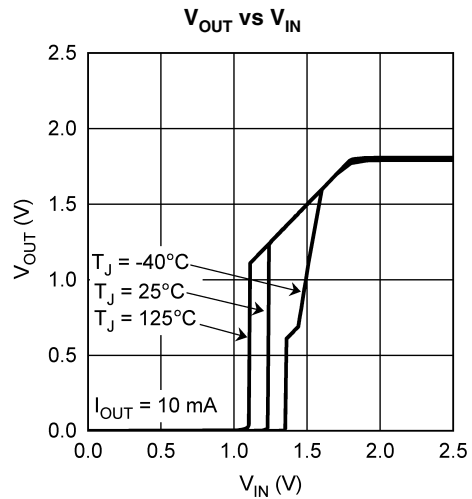

20146837

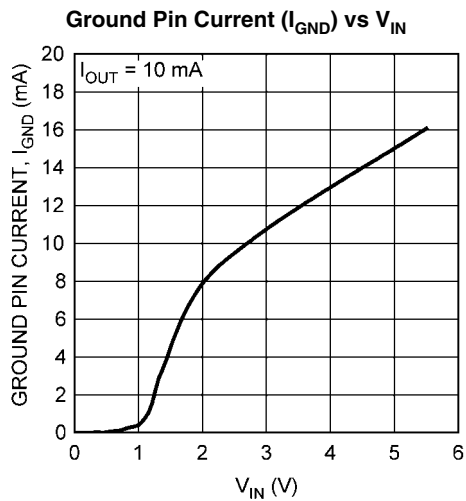

20146812

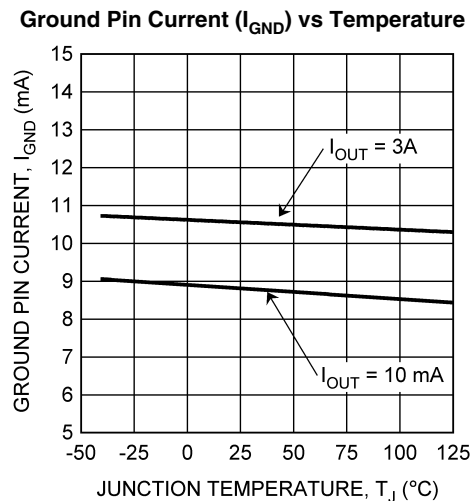

20146813

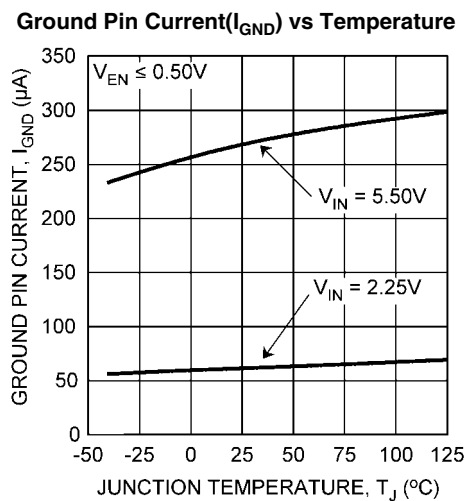

20146814

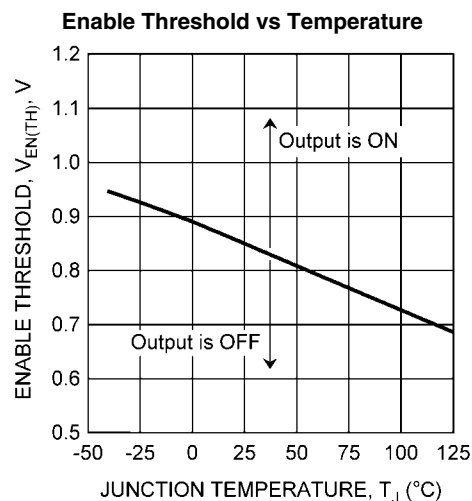

20146816

查询"LP38513"供应商

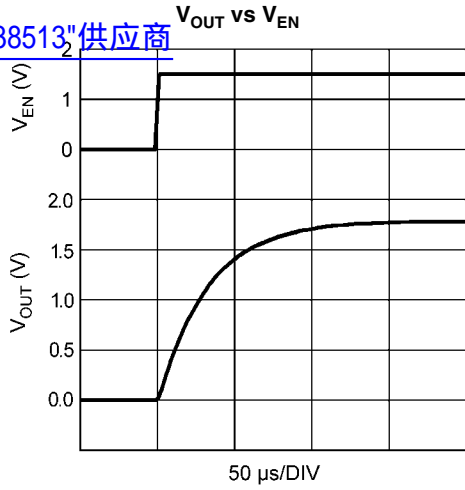

20146832

V_{OUT} ERROR Flag Threshold vs Temperature

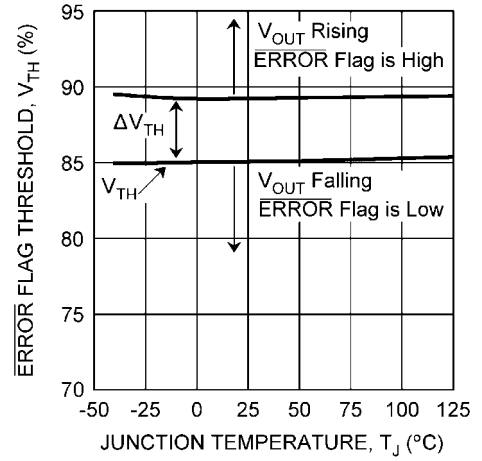

20146817

ERROR Flag Low vs Temperature

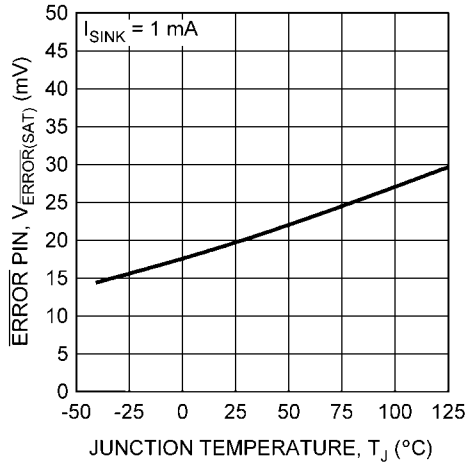

20146818

ERROR Flag Leakage vs Temperature

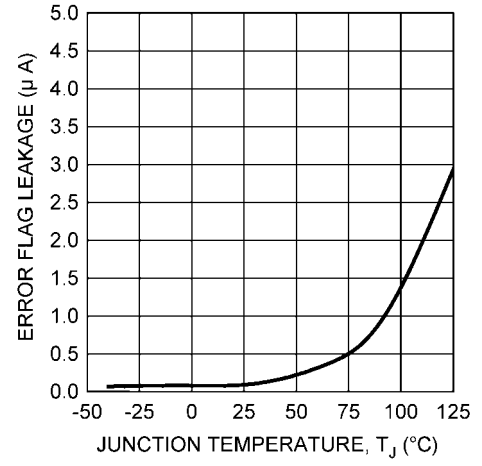

20146819

Load regulation vs Temperature

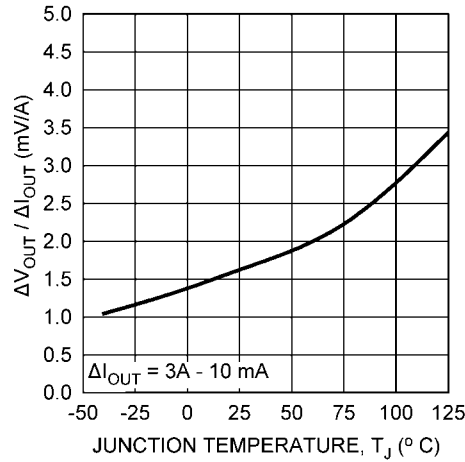

20146820

Line Regulation vs Temperature

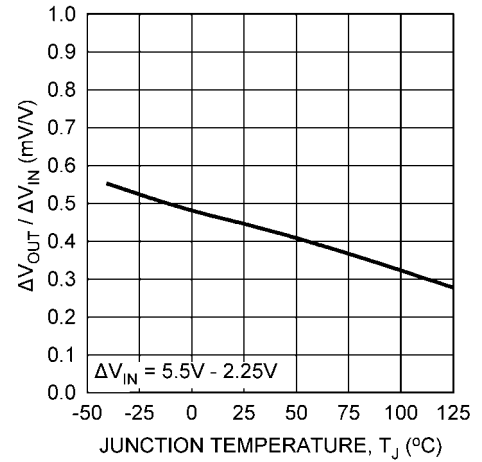

20146821

Current Limit vs Temperature
[查询"LP38513"供应商](#)

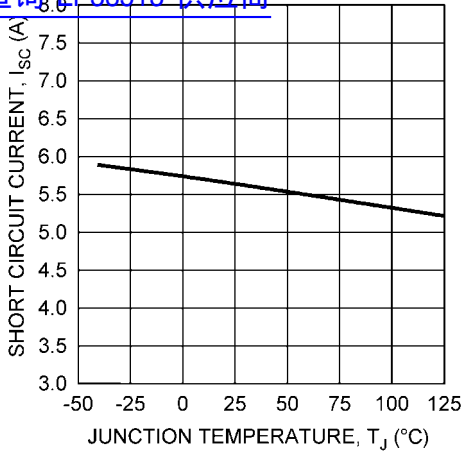

20146822

Load Transient 10mA to 3A,
 $C_{OUT} = 10 \mu F$ Ceramic

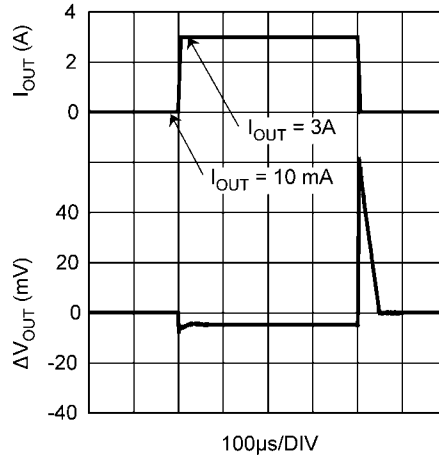

20146823

Load Transient 10 mA to 3A,
 $C_{OUT} = 10 \mu F$ Ceramic + 100 μF Aluminum

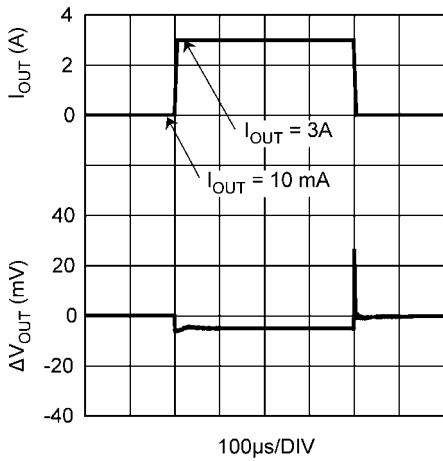

20146824

Load Transient 1A to 3A,
 $C_{OUT} = 10 \mu F$ Ceramic

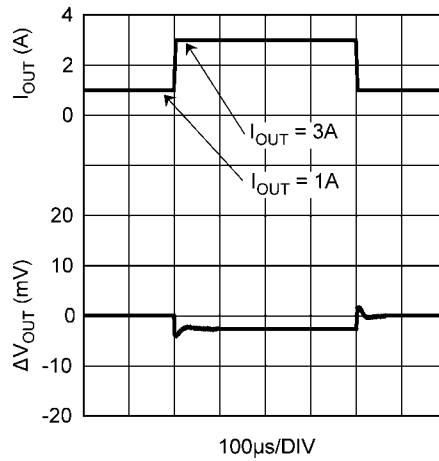

20146825

Load Transient 1A to 3A,
 $C_{OUT} = 10 \mu F$ Ceramic + 100 μF Aluminum

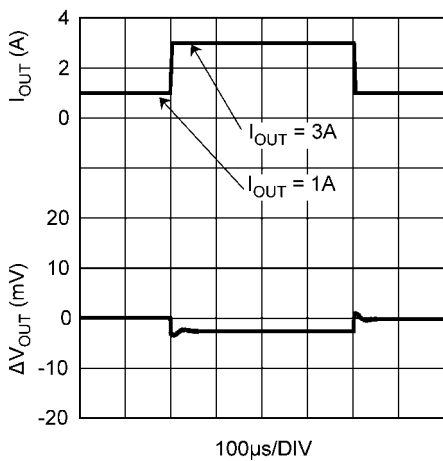

20146826

Line Transient

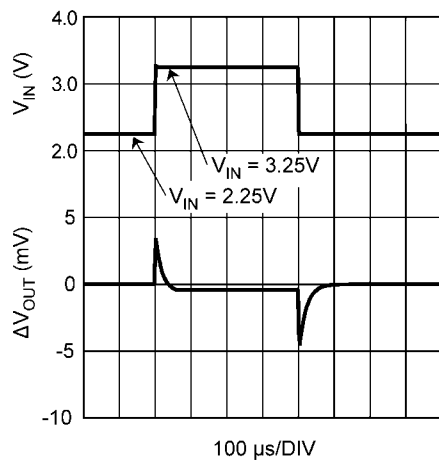

20146827

[查询"LP38513"供应商](#)

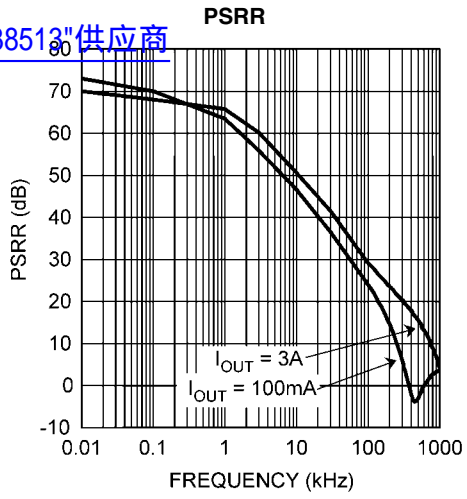

20146829

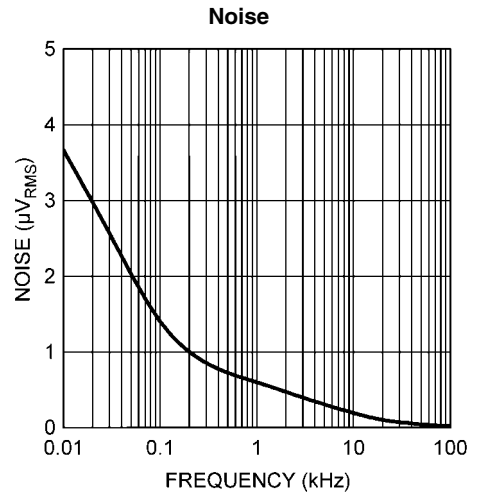

20146831

Block Diagram

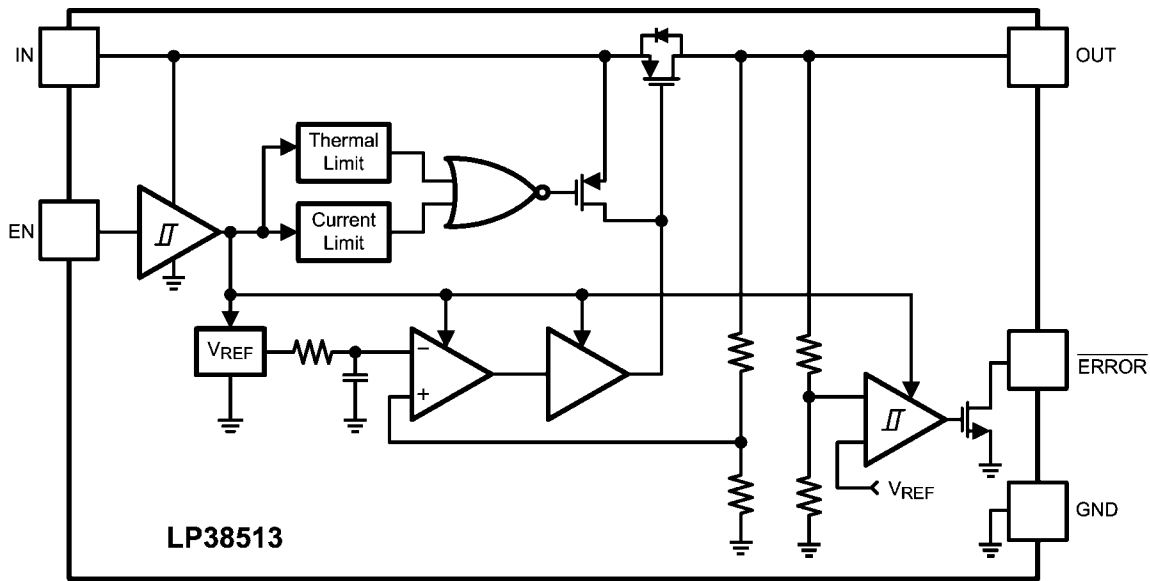

20146807

Application Information

EXTERNAL CAPACITORS

Like any low-dropout regulator, external capacitors are required to assure stability. These capacitors must be correctly selected for proper performance.

INPUT CAPACITOR:

A ceramic input capacitor of at least 10 μF is required. For general usage across all load currents and operating conditions, a 10 μF ceramic input capacitor will provide satisfactory performance.

OUTPUT CAPACITOR:

A ceramic capacitor with a minimum value of 10 μF is required at the output pin for loop stability. It must be located less than 1 cm from the device and connected directly to the output and ground pin using traces which have no other currents flowing through them. As long as the minimum of 10 μF ceramic is met, there is no limitation on any additional capacitance.

X7R and X5R dielectric ceramic capacitors are strongly recommended, as they typically maintain a capacitance range within $\pm 20\%$ of nominal over full operating ratings of temperature and voltage. Of course, they are typically larger and more costly than Z5U/Y5U types for a given voltage and capacitance.

Z5U and Y5V dielectric ceramics are not recommended as the capacitance will drop severely with applied voltage. A typical Z5U or Y5V capacitor can lose 60% of its rated capacitance with half of the rated voltage applied to it. The Z5U and Y5V also exhibit a severe temperature effect, losing more than 50% of nominal capacitance at high and low limits of the temperature range.

REVERSE VOLTAGE

A reverse voltage condition will exist when the voltage at the output pin is higher than the voltage at the input pin. Typically this will happen when V_{IN} is abruptly taken low and C_{OUT} continues to hold a sufficient charge such that the input to output

voltage becomes reversed. A less common condition is when an alternate voltage source is connected to the output.

There are two possible paths for current to flow from the output pin back to the input during a reverse voltage condition.

While V_{IN} is high enough to keep the control circuitry alive, and the Enable pin is above the $V_{\text{EN(ON)}}$ threshold, the control circuitry will attempt to regulate the output voltage. Since the input voltage is less than the output voltage the control circuit will drive the gate of the pass element to the full on condition when the output voltage begins to fall. In this condition, reverse current will flow from the output pin to the input pin, limited only by the $R_{\text{DS(ON)}}$ of the pass element and the output to input voltage differential. Discharging an output capacitor up to 1000 μF in this manner will not damage the device as the current will rapidly decay. However, continuous reverse current should be avoided.

The internal PFET pass element in the LP38513 has an inherent parasitic diode. During normal operation, the input voltage is higher than the output voltage and the parasitic diode is reverse biased. However, if the output voltage to input voltage differential is more than 500 mV (typical) the parasitic diode becomes forward biased and current flows from the output pin to the input through the diode. The current in the parasitic diode should be limited to less than 1A continuous and 5A peak.

If used in a dual-supply system where the regulator output load is returned to a negative supply, the output pin must be diode clamped to ground. A Schottky diode is recommended for this protective clamp.

SHORT-CIRCUIT PROTECTION

The LP38513 is short circuit protected, and in the event of a peak over-current condition the short-circuit control loop will rapidly drive the output PMOS pass element off. Once the power pass element shuts down, the control loop will rapidly cycle the output on and off until the average power dissipation causes the thermal shutdown circuit to respond to servo the

on/off cycling to a lower frequency. Please refer to the *POWER DISSIPATION/HEAT-SINKING* section for power dissipation calculations.

ENABLE OPERATION

The Enable On/Off threshold is typically 850 mV, and has no hysteresis. The voltage signal must rise and fall cleanly, and promptly, through this threshold.

The Enable pin (EN) has no internal pull-up or pull-down to establish a default condition and, as a result, this pin must be terminated either actively or passively.

If the Enable pin is driven from a single ended device (such as the collector of a discrete transistor) a pull-up resistor to V_{IN} , or a pull-down resistor to ground, will be required for proper operation. A 1 k Ω to 100 k Ω resistor can be used as the pull-up or pull-down resistor to establish default condition for the EN pin. The resistor value selected should be appropriate to swamp out any leakage in the external single ended device, as well as any stray capacitance.

If the Enable pin is driven from a source that actively pulls high and low (such as a CMOS rail to rail comparator output), the pull-up, or pull-down, resistor is not required.

If the application does not require the Enable function, the pin should be connected directly to the adjacent V_{IN} pin.

The status of the Enable pin also affects the behavior of the $\overline{\text{ERROR}}$ Flag. While the Enable pin is high the regulator control loop will be active and the $\overline{\text{ERROR}}$ Flag will report the status of the output voltage. When the Enable pin is taken low the regulator control loop is shutdown, the output is turned off, and the internal logic will immediately force the $\overline{\text{ERROR}}$ Flag pin low.

ERROR FLAG OPERATION

When the LP38513 Enable pin is high, the $\overline{\text{ERROR}}$ Flag pin will produce a logic low signal when the output drops by more than 15% (V_{TH} , typical) from the nominal output voltage. The drop in output voltage may be due to low input voltage, current limiting, or thermal limiting. This flag has a built in hysteresis. The output voltage will need to rise to greater than typically 89% of the nominal output voltage for the $\overline{\text{ERROR}}$ Flag to return to a logic high state. It should also be noted that when the Enable pin is pulled low, the $\overline{\text{ERROR}}$ Flag pin is forced to be low as well.

The internal $\overline{\text{ERROR}}$ flag comparator has an open drain output stage. Hence, the $\overline{\text{ERROR}}$ pin requires an external pull-up resistor. The value of the pull-up resistor should be in the range of 2 k Ω to 20 k Ω , and should be connected to the LP38513 output voltage pin. The $\overline{\text{ERROR}}$ Flag pin should not be pulled-up to any voltage source higher than V_{IN} as current flow through an internal parasitic diode may cause unexpected behavior. When the input voltage is less than typically 1.25V the status of the $\overline{\text{ERROR}}$ flag output will not be reliable. The $\overline{\text{ERROR}}$ Flag pin must be connected to ground if this function is not used.

The timing diagram in *Figure 1* shows the relationship between the $\overline{\text{ERROR}}$ flag and the output voltage when the pull-up resistor is connected to the output voltage pin.

The timing diagram in *Figure 2* shows the relationship between the $\overline{\text{ERROR}}$ flag and the output voltage when the pull-up resistor is connected to the input voltage.

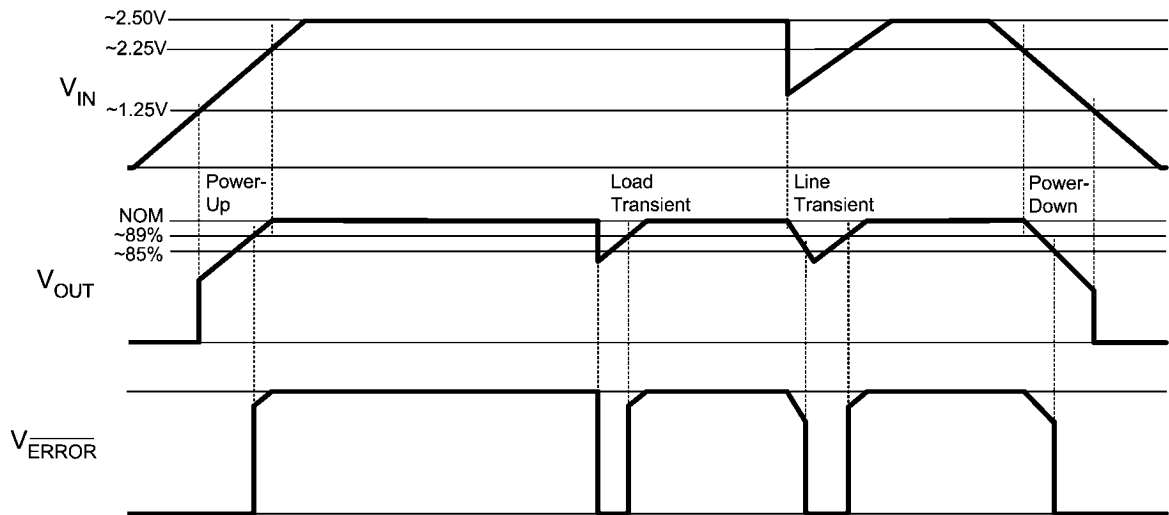

20146808

FIGURE 1. $\overline{\text{ERROR}}$ Flag Operation, see Typical Application

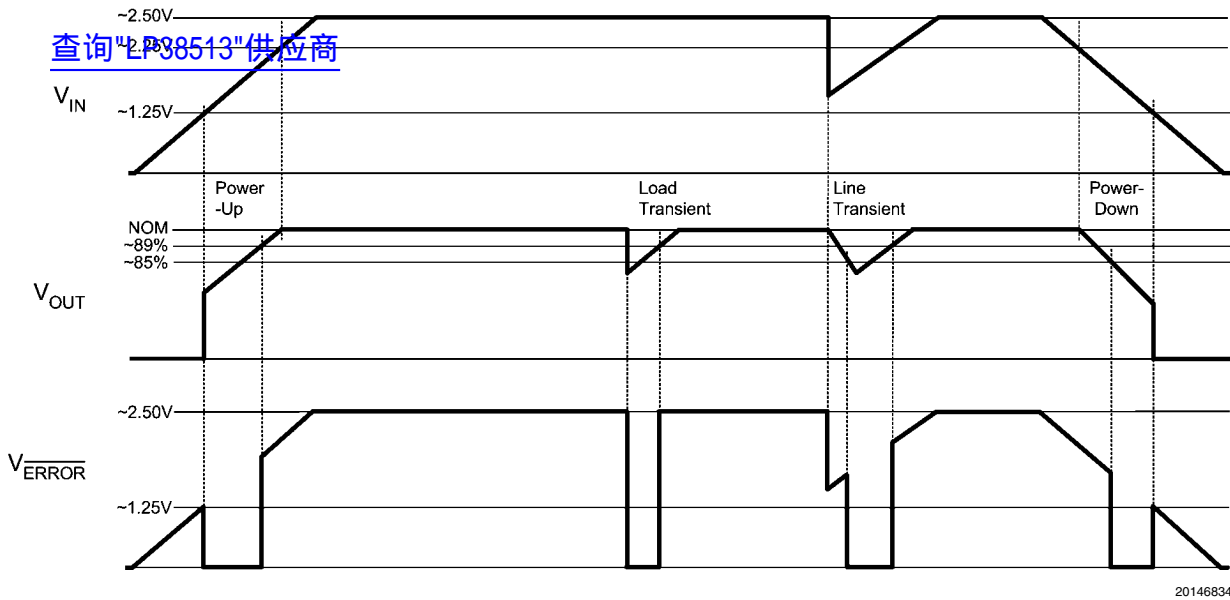

FIGURE 2. $\overline{\text{ERROR}}$ Flag Operation, biased from V_{IN}

POWER DISSIPATION/HEAT-SINKING

A heat-sink may be required depending on the maximum power dissipation ($P_{\text{D(MAX)}}$), maximum ambient temperature ($T_{\text{A(MAX)}}$) of the application, and the thermal resistance (θ_{JA}) of the package. Under all possible conditions, the junction temperature (T_{J}) must be within the range specified in the Operating Ratings. The total power dissipation of the device is given by:

$$P_{\text{D}} = (V_{\text{IN}} - V_{\text{OUT}}) \times I_{\text{OUT}} + (V_{\text{IN}}) \times I_{\text{GND}} \quad (1)$$

where I_{GND} is the operating ground current of the device (specified under Electrical Characteristics).

The maximum allowable junction temperature rise (ΔT_{J}) depends on the maximum expected ambient temperature ($T_{\text{A(MAX)}}$) of the application, and the maximum allowable junction temperature ($T_{\text{J(MAX)}}$):

$$\Delta T_{\text{J}} = T_{\text{J(MAX)}} - T_{\text{A(MAX)}} \quad (2)$$

The maximum allowable value for junction to ambient Thermal Resistance, θ_{JA} , can be calculated using the formula:

$$\theta_{\text{JA}} = \Delta T_{\text{J}} / P_{\text{D(MAX)}} \quad (3)$$

LP38513 is available in TO-220 and TO-263 packages. The thermal resistance depends on amount of copper area or heat sink, and on air flow. If the maximum allowable value of θ_{JA} calculated above is ≥ 60 °C/W for TO-220 package and ≥ 60 °C/W for TO-263 package no heat-sink is needed since the package can dissipate enough heat to satisfy these requirements. If the value for allowable θ_{JA} falls below these limits, a heat sink is required.

HEAT-SINKING THE TO-220 PACKAGE

The thermal resistance of a TO-220 package can be reduced by attaching it to a heat-sink or a copper plane on a PC board.

If a copper plane is to be used, the values of θ_{JA} will be the same as shown in the next section for the TO263 package.

The heatsink to be used in the application should have a heat-sink to ambient thermal resistance,

$$\theta_{\text{HA}} \leq \theta_{\text{JA}} - \theta_{\text{CH}} - \theta_{\text{JC}} \quad (4)$$

In this equation, θ_{CH} is the thermal resistance from the case to the surface of the heat sink and θ_{JC} is the thermal resistance from the junction to the surface of the case. The rated θ_{JC} is about 3°C/W for a TO220-5 package. The value for θ_{CH} depends on method of attachment, insulator, etc. θ_{CH} varies between 1.5°C/W to 2.5°C/W. If the exact value is unknown, 2°C/W can be assumed.

HEAT-SINKING THE TO-263 PACKAGE

The TO-263 package uses the copper plane on the PCB as a heat-sink. The tab of this package is soldered to the copper plane for heat sinking. Figure 3 shows a curve for the θ_{JA} of TO-263 package for different copper area sizes, using a typical PCB with 1 ounce copper and no solder mask over the copper area for heat sinking.

查询"LP38513"供应商

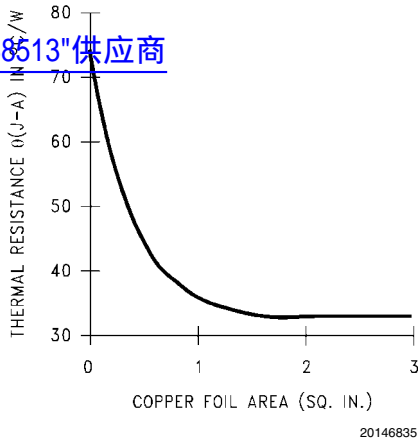

FIGURE 3. θ_{JA} vs Copper (1 Ounce) Area for the TO-263 package

As shown in the figure, increasing the copper area beyond 1 square inch produces very little improvement. The minimum value for θ_{JA} for the TO-263 package mounted to a PCB is 32°C/W.

Figure 4 shows the maximum allowable power dissipation for TO-263 packages for different ambient temperatures, assuming θ_{JA} is 35°C/W and the maximum junction temperature is 125°C.

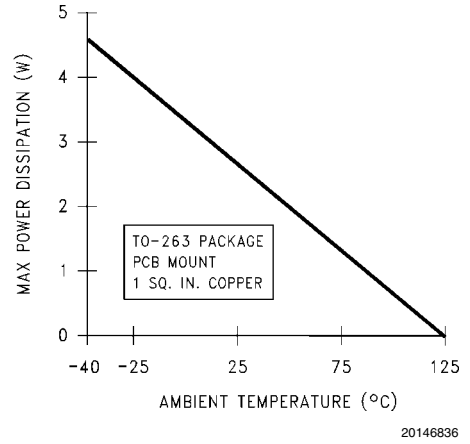
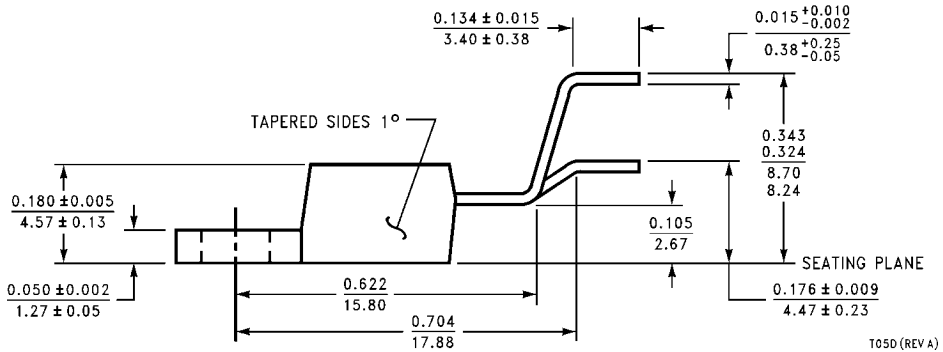
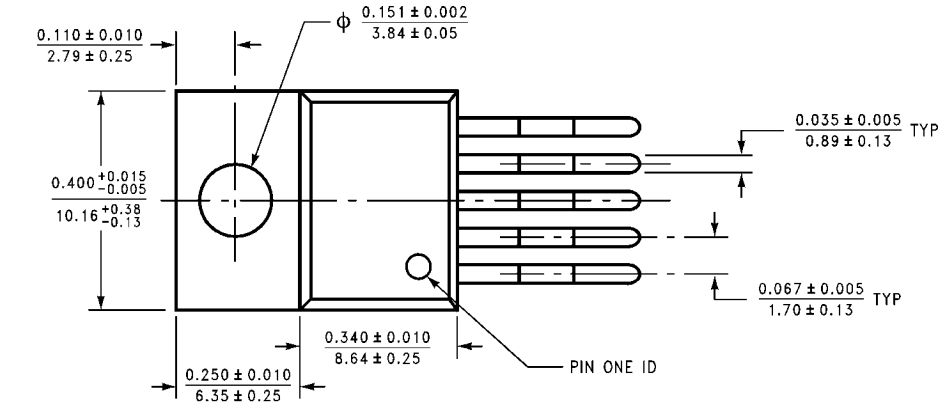

FIGURE 4. Maximum Power Dissipation vs Ambient Temperature for the TO-263 Package

Physical Dimensions inches (millimeters) unless otherwise noted
[查询"LP38513"供应商](#)

LP38513-1.8



**TO220 5-lead, Molded, Stagger Bend Package
 NS Package Number T05D**

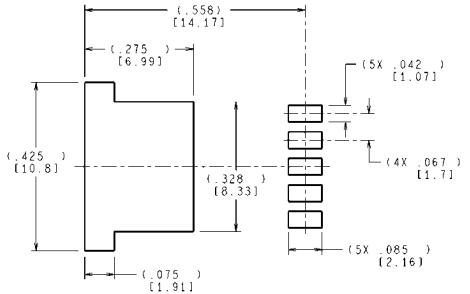
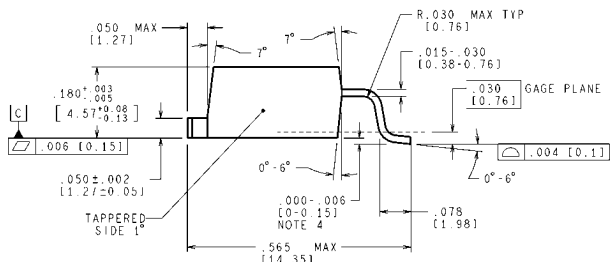
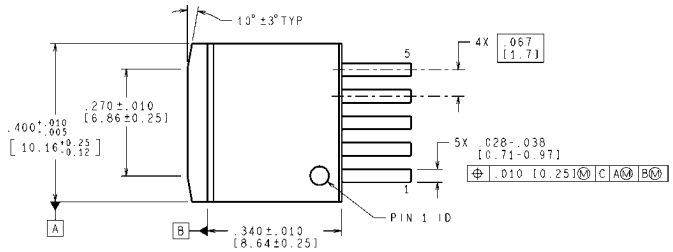

LAND PATTERN RECOMMENDATION

CONTROLLING DIMENSION IS INCH
 VALUES IN [] ARE MILLIMETERS
 DIMENSIONS IN () FOR REFERENCE ONLY

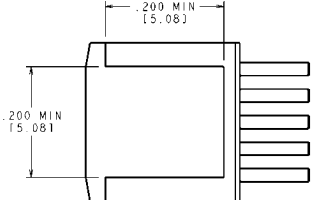

**TO263 5-Lead, Molded, Surface Mount Package
 NS Package Number TS5B**

TS5B (Rev D)

[查询"LP38513"供应商](#)

Notes

For more National Semiconductor product information and proven design tools, visit the following Web sites at:

Products		Design Support	
Amplifiers	www.national.com/amplifiers	WEBENCH® Tools	www.national.com/webench
Audio	www.national.com/audio	App Notes	www.national.com/appnotes
Clock and Timing	www.national.com/timing	Reference Designs	www.national.com/refdesigns
Data Converters	www.national.com/adc	Samples	www.national.com/samples
Interface	www.national.com/interface	Eval Boards	www.national.com/evalboards
LVDS	www.national.com/lvds	Packaging	www.national.com/packaging
Power Management	www.national.com/power	Green Compliance	www.national.com/quality/green
Switching Regulators	www.national.com/switchers	Distributors	www.national.com/contacts
LDOs	www.national.com/ldo	Quality and Reliability	www.national.com/quality
LED Lighting	www.national.com/led	Feedback/Support	www.national.com/feedback
Voltage Reference	www.national.com/vref	Design Made Easy	www.national.com/easy
PowerWise® Solutions	www.national.com/powerwise	Solutions	www.national.com/solutions
Serial Digital Interface (SDI)	www.national.com/sdi	Mil/Aero	www.national.com/milaero
Temperature Sensors	www.national.com/tempsensors	SolarMagic™	www.national.com/solarmagic
Wireless (PLL/VCO)	www.national.com/wireless	Analog University®	www.national.com/AU

THE CONTENTS OF THIS DOCUMENT ARE PROVIDED IN CONNECTION WITH NATIONAL SEMICONDUCTOR CORPORATION ("NATIONAL") PRODUCTS. NATIONAL MAKES NO REPRESENTATIONS OR WARRANTIES WITH RESPECT TO THE ACCURACY OR COMPLETENESS OF THE CONTENTS OF THIS PUBLICATION AND RESERVES THE RIGHT TO MAKE CHANGES TO SPECIFICATIONS AND PRODUCT DESCRIPTIONS AT ANY TIME WITHOUT NOTICE. NO LICENSE, WHETHER EXPRESS, IMPLIED, ARISING BY ESTOPPEL OR OTHERWISE, TO ANY INTELLECTUAL PROPERTY RIGHTS IS GRANTED BY THIS DOCUMENT.

TESTING AND OTHER QUALITY CONTROLS ARE USED TO THE EXTENT NATIONAL DEEMS NECESSARY TO SUPPORT NATIONAL'S PRODUCT WARRANTY. EXCEPT WHERE MANDATED BY GOVERNMENT REQUIREMENTS, TESTING OF ALL PARAMETERS OF EACH PRODUCT IS NOT NECESSARILY PERFORMED. NATIONAL ASSUMES NO LIABILITY FOR APPLICATIONS ASSISTANCE OR BUYER PRODUCT DESIGN. BUYERS ARE RESPONSIBLE FOR THEIR PRODUCTS AND APPLICATIONS USING NATIONAL COMPONENTS. PRIOR TO USING OR DISTRIBUTING ANY PRODUCTS THAT INCLUDE NATIONAL COMPONENTS, BUYERS SHOULD PROVIDE ADEQUATE DESIGN, TESTING AND OPERATING SAFEGUARDS.

EXCEPT AS PROVIDED IN NATIONAL'S TERMS AND CONDITIONS OF SALE FOR SUCH PRODUCTS, NATIONAL ASSUMES NO LIABILITY WHATSOEVER, AND NATIONAL DISCLAIMS ANY EXPRESS OR IMPLIED WARRANTY RELATING TO THE SALE AND/OR USE OF NATIONAL PRODUCTS INCLUDING LIABILITY OR WARRANTIES RELATING TO FITNESS FOR A PARTICULAR PURPOSE, MERCHANTABILITY, OR INFRINGEMENT OF ANY PATENT, COPYRIGHT OR OTHER INTELLECTUAL PROPERTY RIGHT.

LIFE SUPPORT POLICY

NATIONAL'S PRODUCTS ARE NOT AUTHORIZED FOR USE AS CRITICAL COMPONENTS IN LIFE SUPPORT DEVICES OR SYSTEMS WITHOUT THE EXPRESS PRIOR WRITTEN APPROVAL OF THE CHIEF EXECUTIVE OFFICER AND GENERAL COUNSEL OF NATIONAL SEMICONDUCTOR CORPORATION. As used herein:

Life support devices or systems are devices which (a) are intended for surgical implant into the body, or (b) support or sustain life and whose failure to perform when properly used in accordance with instructions for use provided in the labeling can be reasonably expected to result in a significant injury to the user. A critical component is any component in a life support device or system whose failure to perform can be reasonably expected to cause the failure of the life support device or system or to affect its safety or effectiveness.

National Semiconductor and the National Semiconductor logo are registered trademarks of National Semiconductor Corporation. All other brand or product names may be trademarks or registered trademarks of their respective holders.

Copyright© 2009 National Semiconductor Corporation

For the most current product information visit us at www.national.com



National Semiconductor Americas Technical Support Center
 Email: support@nsc.com
 Tel: 1-800-272-9959

National Semiconductor Europe Technical Support Center
 Email: europe.support@nsc.com

National Semiconductor Asia Pacific Technical Support Center
 Email: ap.support@nsc.com

National Semiconductor Japan Technical Support Center
 Email: jpn.feedback@nsc.com