

BA592WS

[查询"BA592WS"供应商](#)

SILICON RF SWITCHING DIODE

Features

- Very low forward resistance
- Small capacitance

Applications

- For band switching in TV/VTR tuners and mobile applications

PINNING

PIN	DESCRIPTION
1	Cathode
2	Anode

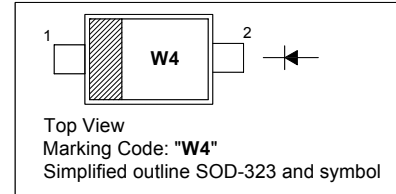

Absolute Maximum Ratings ($T_a = 25\text{ }^\circ\text{C}$)

Parameter	Symbol	Value	Unit
Diode Reverse Voltage	V_R	35	V
Forward Current	I_F	100	mA
Junction Temperature	T_J	150	$^\circ\text{C}$
Operating Temperature Range	T_{op}	- 55 to + 125	$^\circ\text{C}$
Storage Temperature Range	T_{stg}	- 55 to + 150	$^\circ\text{C}$

Electrical Characteristics at $T_a = 25\text{ }^\circ\text{C}$

Parameter	Symbol	Min.	Typ.	Max.	Unit
Reverse Current at $V_R = 20\text{ V}$	I_R	-	-	20	nA
Forward Voltage at $I_F = 100\text{ mA}$	V_F	-	-	1	V
Diode Capacitance at $V_R = 1\text{ V}$, $f = 1\text{ MHz}$ at $V_R = 3\text{ V}$, $f = 1\text{ MHz}$	C_T	0.65 0.6	- -	1.4 1.1	pF
Reverse Parallel Resistance at $V_R = 0\text{ V}$, $f = 100\text{ MHz}$	R_P	-	100	-	K Ω
Forward Resistance at $I_F = 3\text{ mA}$, $f = 100\text{ MHz}$ at $I_F = 10\text{ mA}$, $f = 100\text{ MHz}$	r_f	- -	- -	0.7 0.5	Ω
Series Inductance	L_s	-	1.8	-	nH

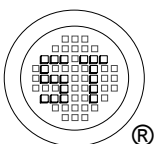

SEMTECH ELECTRONICS LTD.

(Subsidiary of Sino-Tech International Holdings Limited, a company listed on the Hong Kong Stock Exchange, Stock Code: 724)



ISO/TS 16949 : 2002
Certificate No. 05103



ISO 14001:2004
Certificate No. 7116



ISO 9001:2000
Certificate No. 0506098

Dated : 01/09/2006

Diode capacitance $C_T=f(V_R)$
f=Parameter

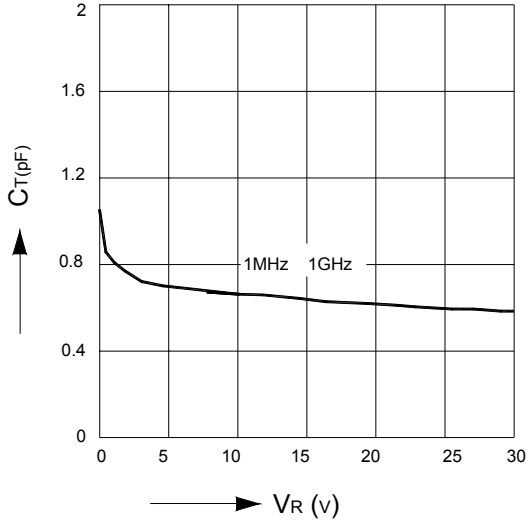

Reverse current $R_P=f(V_R)$
f=Parameter

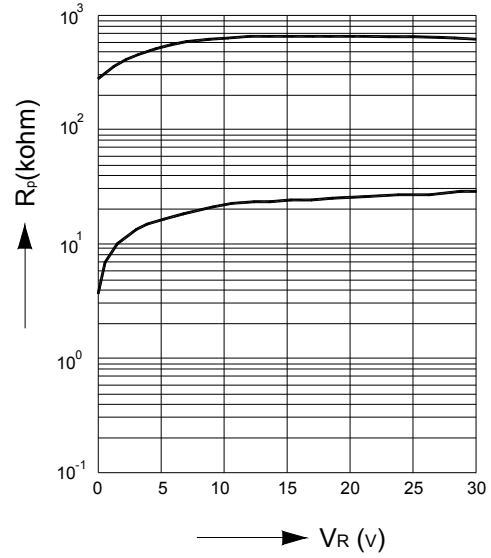

Forward resistance $r_f=f(I_F)$
f=100MHz

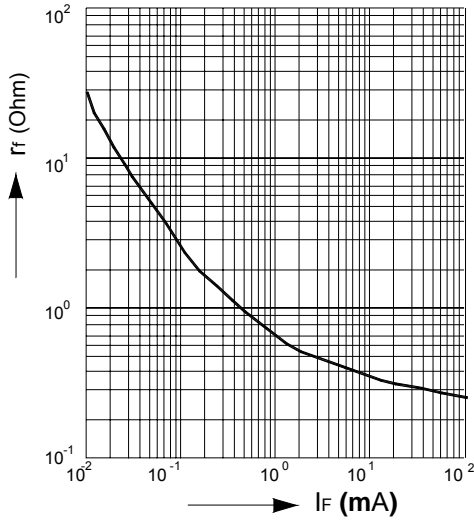

Forward current $I_F=f(V_F)$
 T_A =Parameter

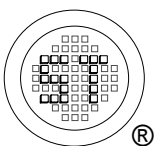
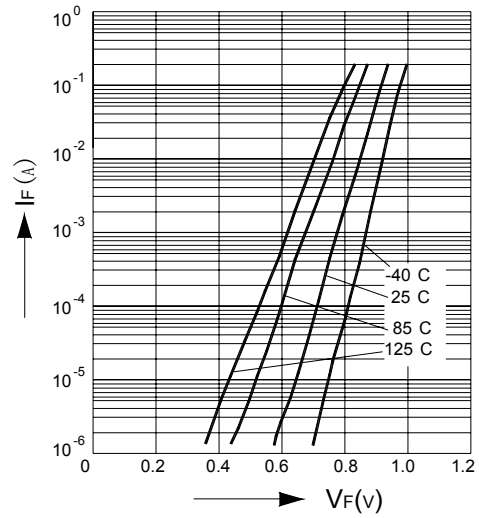

SEMTECH ELECTRONICS LTD.

(Subsidiary of Sino-Tech International Holdings Limited, a company listed on the Hong Kong Stock Exchange, Stock Code: 724)



ISO/TS 16949 : 2002 Certificate No. 05103
ISO 14001:2004 Certificate No. 7116
ISO 9001:2000 Certificate No. 0506098

Dated : 01/09/2006

BA592WS

[查询"BA592WS"供应商](#)

PACKAGE OUTLINE

Plastic surface mounted package; 2 leads

SOD-323

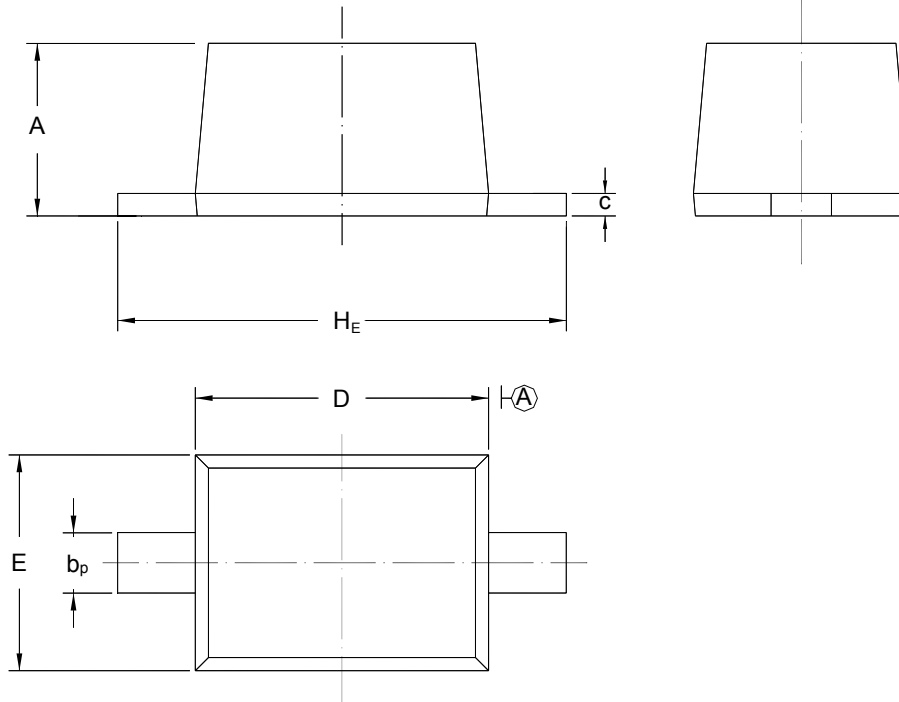

UNIT	A	b _p	C	D	E	H _E
mm	1.10 0.80	0.40 0.25	0.15 0.00	1.80 1.60	1.35 1.15	2.80 2.30

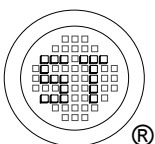

SEMTECH ELECTRONICS LTD.

(Subsidiary of Sino-Tech International Holdings Limited, a company listed on the Hong Kong Stock Exchange, Stock Code: 724)



ISO/TS 16949 : 2002 Certificate No. 05103
 ISO 14001:2004 Certificate No. 7116
 ISO 9001:2000 Certificate No. 0506098

Dated : 01/09/2006