

V_{RSM}	=	5200 V
I_{FAVM}	=	1978 A
I_{FRMS}	=	3106 A
I_{FSM}	=	25.6×10^3 A
V_{F0}	=	0.94 V
r_F	=	0.284 m Ω

Rectifier Diode

5SDD 20F5000

Doc. No. 5SYA1162-01 Jan. 03

- Very low on-state losses
- Optimum power handling capability

Blocking

Maximum rated values ¹⁾

Parameter	Symbol	Conditions	Value	Unit
Repetitive peak reverse voltage	V_{RRM}	$f = 50$ Hz, $t_p = 10$ ms, $T_j = -40 \dots 160^\circ\text{C}$	5000	V
Non - repetitive peak reverse voltage	V_{RSM}	$f = 5$ Hz, $t_p = 10$ ms, $T_j = -40 \dots 160^\circ\text{C}$	5200	V

Characteristic values

Parameter	Symbol	Conditions	min	typ	max	Unit
Max. (reverse) leakage current	I_{RRM}	V_{RRM} , $T_j = 160^\circ\text{C}$			50	mA

Mechanical data

Maximum rated values ¹⁾

Parameter	Symbol	Conditions	min	typ	max	Unit
Mounting force	F_M		20	22	24	kN
Acceleration	a	Device unclamped			50	m/s ²
Acceleration	a	Device clamped			100	m/s ²

Characteristic values

Parameter	Symbol	Conditions	min	typ	max	Unit
Weight	m			0.5		kg
Housing thickness	H			26		mm
Pole-piece diameter	D_P			47		mm
Surface creepage distance	D_S		33			mm
Air strike distance	D_a		18			mm

1) Maximum rated values indicate limits beyond which damage to the device may occur

ABB Switzerland Ltd, Semiconductors reserves the right to change specifications without notice.



On-state

Maximum rated values ¹⁾

Parameter	Symbol	Conditions	min	typ	max	Unit
Max. average on-state current	I _{FAVM}	50 Hz, Half sine wave, T _C = 85 °C			1978	A
Max. RMS on-state current	I _{FRMS}				3106	A
Max. peak non-repetitive surge current	I _{FSM}	t _p = 10 ms, T _j = 160°C, V _R = 0 V			25.6×10 ³	A
Limiting load integral	I ² t				2.727×10 ⁶	A ² s
Max. peak non-repetitive surge current	I _{FSM}	t _p = 8.3 ms, T _j = 160°C, V _R = 0 V			24×10 ³	A
Limiting load integral	I ² t				2.88×10 ⁶	A ² s

Characteristic values

Parameter	Symbol	Conditions	min	typ	max	Unit
On-state voltage	V _F	I _F = 4000 A, T _j = 160°C			2.1	V
Threshold voltage	V _(T0)	T _j = 160°C			0.94	V
Slope resistance	r _T	I _T = 2827...8480 A			0.284	mΩ

Switching

Characteristic values

Parameter	Symbol	Conditions	min	typ	max	Unit
Recovery charge	Q _{rr}	di _F /dt = -30 A/μs, V _R = 100 V I _{FRM} = 1000 A, T _j = 160°C		4500	5500	μAs

Thermal

Maximum rated values ¹⁾

Parameter	Symbol	Conditions	min	typ	max	Unit
Operating junction temperature range	T _{vj}		-40		160	°C
Storage temperature range	T _{stg}		-40		160	°C

Characteristic values

Parameter	Symbol	Conditions	min	typ	max	Unit
Thermal resistance junction to case	R _{th(j-c)}	Double-side cooled			15	K/kW
	R _{th(j-c)A}	Anode-side cooled			24	K/kW
	R _{th(j-c)C}	Cathode-side cooled			40	K/kW
Thermal resistance case to heatsink	R _{th(c-h)}	Double-side cooled			4	K/kW
	R _{th(c-h)}	Single-side cooled			8	K/kW

Analytical function for transient thermal impedance:

$$Z_{thJC}(t) = \sum_{i=1}^n R_i(1 - e^{-t/\tau_i})$$

i	1	2	3	4
R _i (K/kW)	6.060	3.850	3.780	1.320
τ _i (s)	0.6937	0.2040	0.0452	0.0040

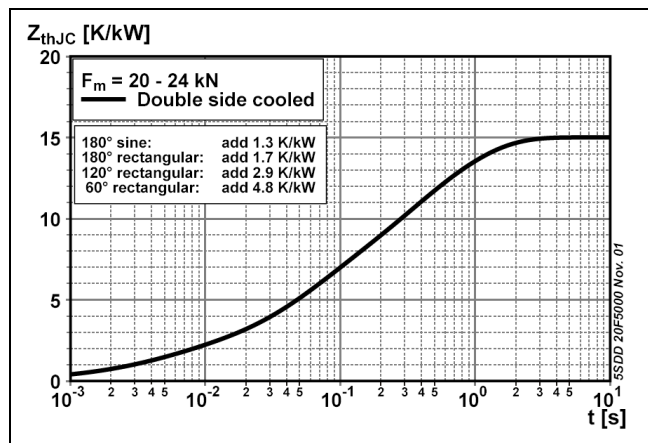

Fig. 1 Transient thermal impedance junction-to-case.

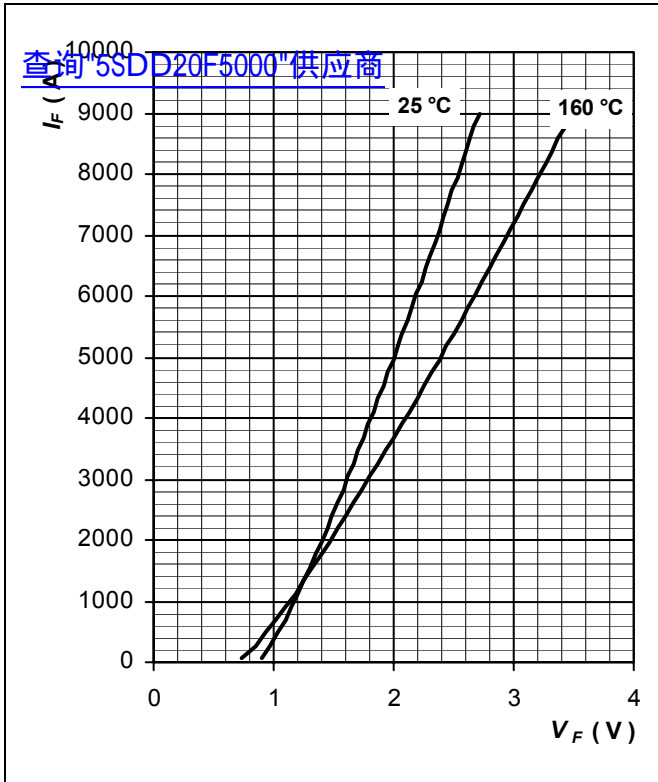

Fig. 2 Max. on-state characteristics.

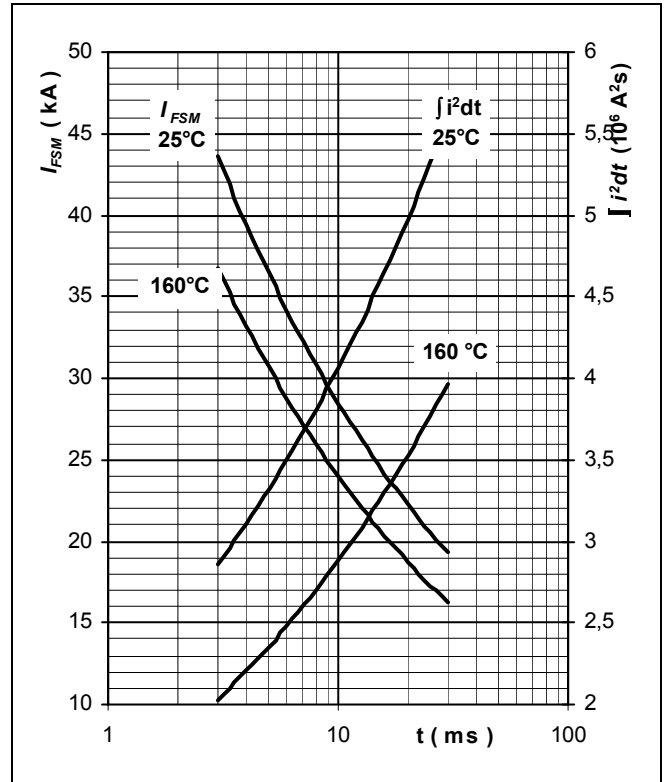

Fig. 3 Surge forward current vs. pulse length. Half sine wave, single pulse, $V_R = 0$ V

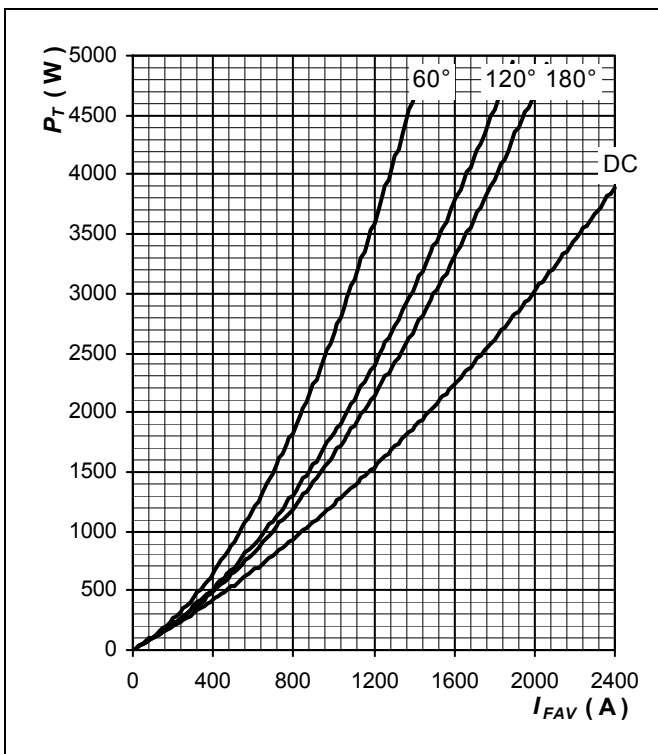

Fig. 4 Forward power loss vs. average forward current, sine waveform, $f = 50$ Hz

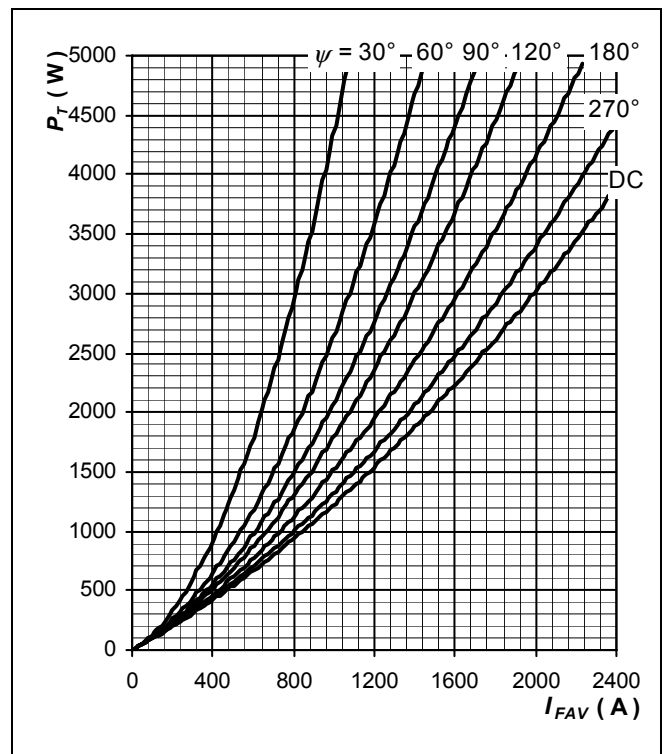

Fig. 5 Forward power loss vs. average forward current, square waveform, $f = 50$ Hz

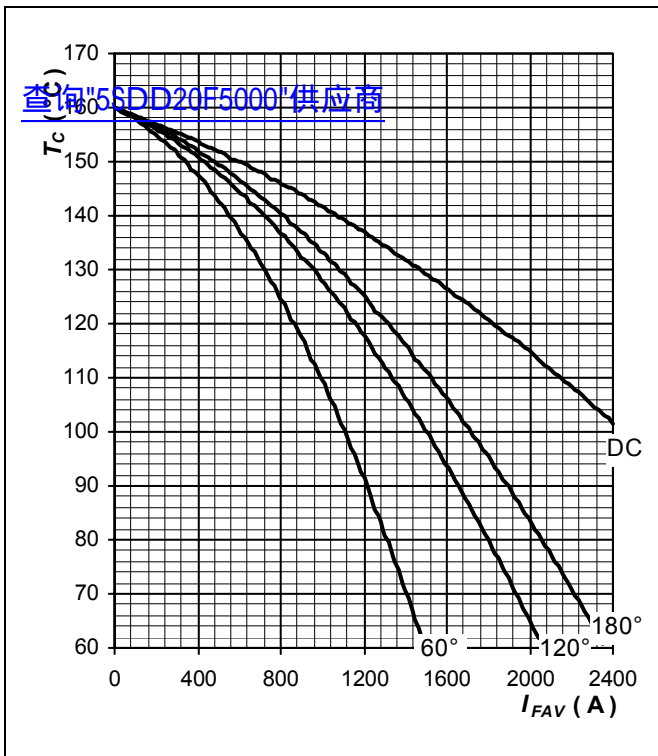

Fig. 6 Max. case temperature vs aver. forward current, sine waveform, $f = 50$ Hz

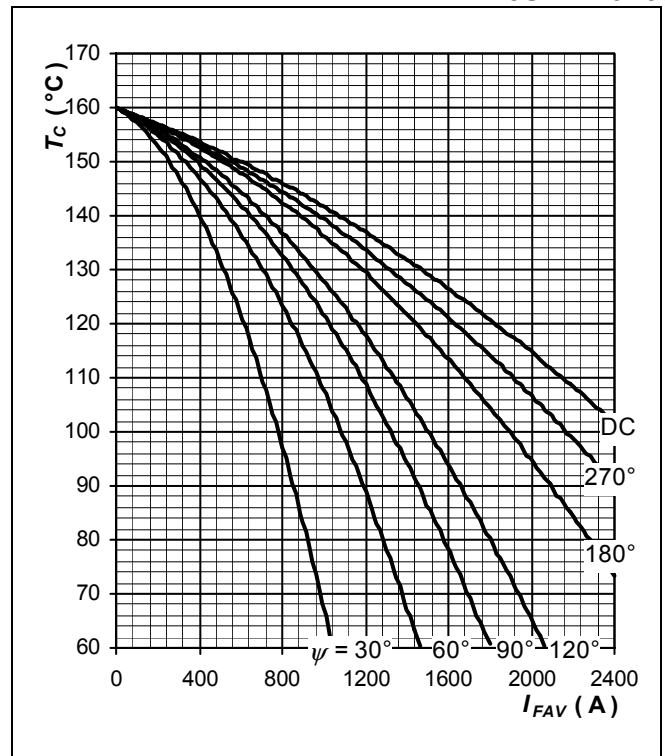

Fig. 7 Max. case temperature vs aver. forward current, square waveform, $f = 50$ Hz

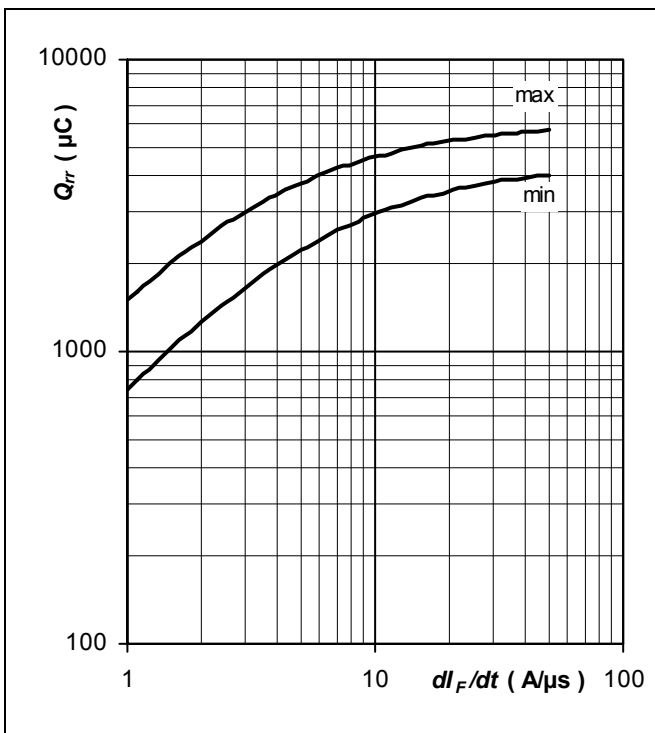

Fig. 8 Reverse recovery charge vs. di_F/dt , $I_F = 1000$ A; $T_j = T_{jmax}$, limit values

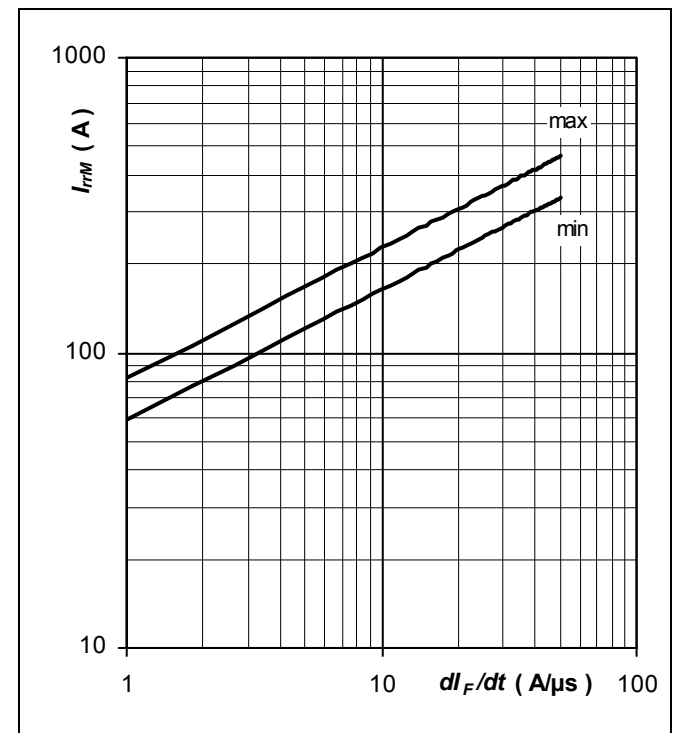

Fig. 9 Peak reverse recovery current vs. di_F/dt , $I_F = 1000$ A; $T_j = T_{jmax}$, limit values

[查询"5SDD20F5000"供应商](#)

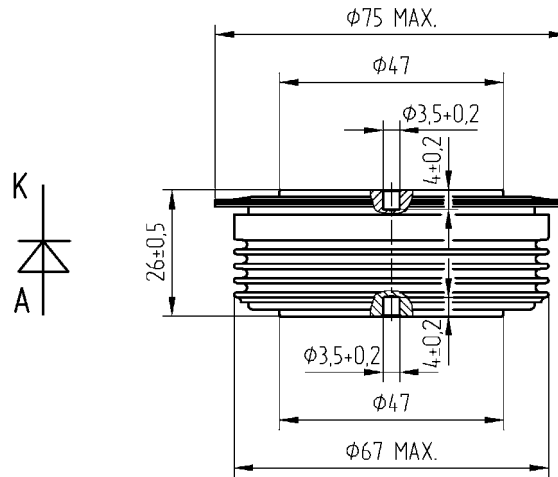

Fig. 10 Outline drawing. All dimensions are in millimeters and represent nominal values unless stated otherwise.

ABB Switzerland Ltd, Semiconductors reserves the right to change specifications without notice.

ABB

ABB Switzerland Ltd
Semiconductors
 Fabrikstrasse 3
 CH-5600 Lenzburg, Switzerland

Doc. No. 5SYA1162-01 Jan. 03

Telephone +41 (0)58 586 1419
 Fax +41 (0)58 586 1306
 Email abbsem@ch.abb.com
 Internet www.abb.com/semiconductors