

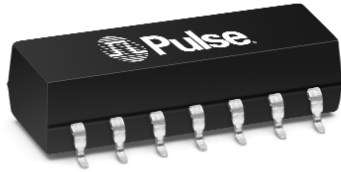





# RF/CABLE LOW PASS FILTERS

[查询"CX5013"供应商](#)



-  For use in HFC, cable modems and termination systems
-  Domestic and international versions
-  Less than 1 dB inband insertion loss
-  Small group delay variation
-  Small surface mount package

Electrical Specifications @ 25°C									
Part Number	In/Out Impedance	Cut-Off Passband Frequency	Insertion Loss (dB MAX)	Return Loss (dB MIN)	GDV (MAX)	Stopband (dB MIN)			Schematics
C5001	150 Ω	50.0 MHz TYP	1.0 @ 1-40 MHz	15 @ 1-40 MHz	30 ns @ 40 MHz	15 @ 75 MHz		28 @ 100-300 MHz	A
C5003	150 Ω	80.0 MHz TYP	1.0 @ 1-65 MHz	15 @ 1-65 MHz	25 ns @ 65 MHz	15 @ 100 MHz		38 @ 165 MHz	A
C5005	75 Ω	59.5 MHz TYP	1.0 @ 1-50 MHz	15 @ 1-50 MHz	—	10 @ 70 MHz	35 @ 100 MHz	40 @ 150-500 MHz	B
CX5013	75 Ω	68.0 MHz TYP	1.5 @ 1-60 MHz	15 @ 1-60 MHz	35 ns @ 60 MHz	15 @ 75 MHz		30 @ 100-500 MHz	B

## Mechanical

## Schematic

### C500X/CX5013

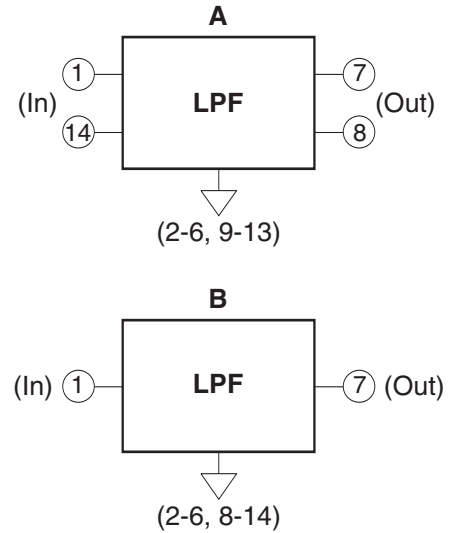
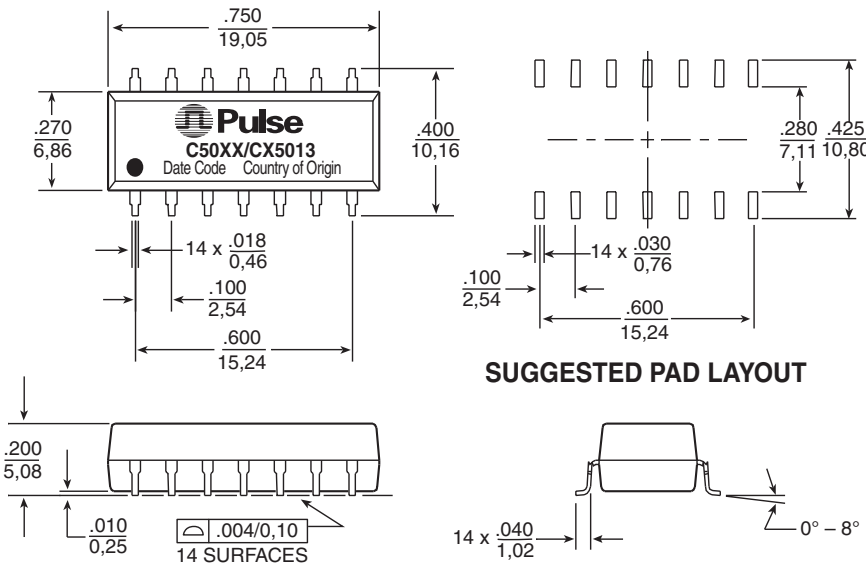

Weight ..... 1.35 grams  
 Tape & Reel ..... .600/reel  
 Tube ..... .25/tube  
 Dimensions:  $\frac{\text{Inches}}{\text{mm}}$   
 Unless otherwise specified,  
 all tolerances are  $\pm \frac{.010}{0,25}$

## For More Information :

UNITED STATES (Worldwide)	UNITED KINGDOM (Northern Europe)	FRANCE (Southern Europe)	SINGAPORE (Southern Asia)	TAIWAN, R.O.C. (Northern Asia)	HONG KONG (China/Hong Kong)	DISTRIBUTOR
12220 World Trade Drive San Diego, CA 92128 U.S.A. http://www.pulseeng.com TEL: 858 674 8100 FAX: 858 674 8262	1 & 2 Huxley Road The Surrey Research Park Guildford, Surrey GU2 5RE United Kingdom TEL: 44 1483 401700 FAX: 44 1483 401701	Zone Industrielle F-39270 Orgelet France TEL: 33 3 84 35 04 04 FAX: 33 3 84 25 46 41	150 Kampong Ampat #07-01/02 KA Centre Singapore 368324 TEL: 65 6287 8998 FAX: 65 6280 0080	3F-4, No. 81, Sec. 1 HsinTai Wu Road Hsi-Chih, Taipei Hsien Taiwan, R.O.C. Tel: 886 2 2698 0228 FAX: 886 2 2698 0948	9/F, Phase 2, Tai Sang Shatin Warehouse Centre 6 Wong Chuk Yeung Street Fotan, Shatin, Hong Kong TEL: 852 2788 6588 FAX: 852 2776 1055	

Performance warranty of products offered on this data sheet is limited to the parameters specified. Data is subject to change without notice. Other brand and product names mentioned herein may be trademarks or registered trademarks of their respective owners.