

Low Vcesat NPN Epitaxial Planar Transistor

BTN3501J3

Features

- Low VCE(sat)
- High BVCEO
- Excellent current gain characteristics

Symbol

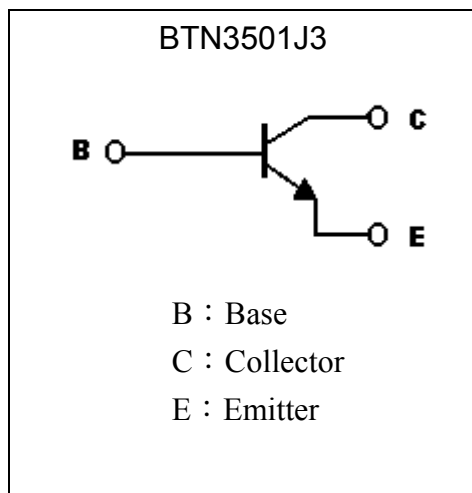

Outline

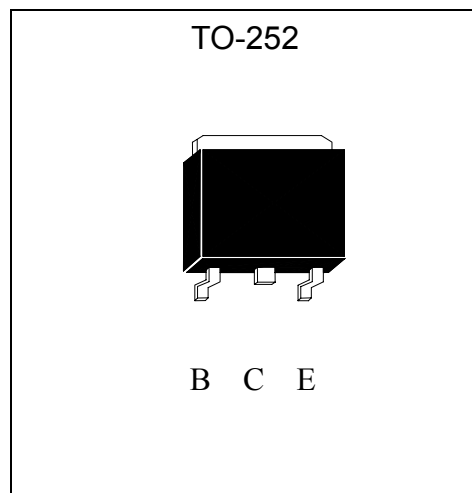

Absolute Maximum Ratings (Ta=25°C)

Parameter	Symbol	Limits	Unit
Collector-Base Voltage	V _{CBO}	80	V
Collector-Emitter Voltage	V _{CEO}	80	V
Emitter-Base Voltage	V _{EBO}	6	V
Collector Current (DC)	I _C	8	A
Collector Current (Pulse)	I _{CP}	16 (Note 1)	
Power Dissipation @ T _A =25°C	P _D	1.75 (Note 2)	W
Power Dissipation @ T _c =25°C	P _D	20	
Thermal Resistance, Junction to Ambient	R _{θJA}	71.4 (Note 2)	°C/W
Thermal Resistance, Junction to Case	R _{θJC}	6.25	°C/W
Junction Temperature	T _j	150	°C
Storage Temperature	T _{stg}	-55~+150	°C

Note : 1. Single Pulse , Pw ≤ 380μs, Duty ≤ 2%.
 2. When mounted on a PCB with the minimum pad size.

Characteristics (Ta=25°C)

Symbol	Min.	Typ.	Max.	Unit	Test Conditions
$BV_{CEO(SUS)}$	80	-	-	V	$I_C=30mA, I_B=0$
I_{CES}	-	-	10	μA	$V_{CE}=80V, V_{BE}=0$
I_{EBO}	-	-	50	μA	$V_{EB}=5V, I_C=0$
* $V_{CE(sat)}$	-	0.3	0.6	V	$I_C=8A, I_B=0.4A$
* $V_{BE(sat)}$	-	1.0	1.5	V	$I_C=8A, I_B=0.8A$
* h_{FE}	60	-	-	-	$V_{CE}=1V, I_C=2A$
* h_{FE}	40	-	-	-	$V_{CE}=1V, I_C=4A$
f_T	-	50	-	MHz	$V_{CE}=6V, I_C=500mA, f=20MHz$
Cob	-	130	-	pF	$V_{CB}=10V, f=1MHz$

*Pulse Test : Pulse Width $\leq 380\mu s$, Duty Cycle $\leq 2\%$

Characteristic Curves

Grounded Emitter Output Characteristics

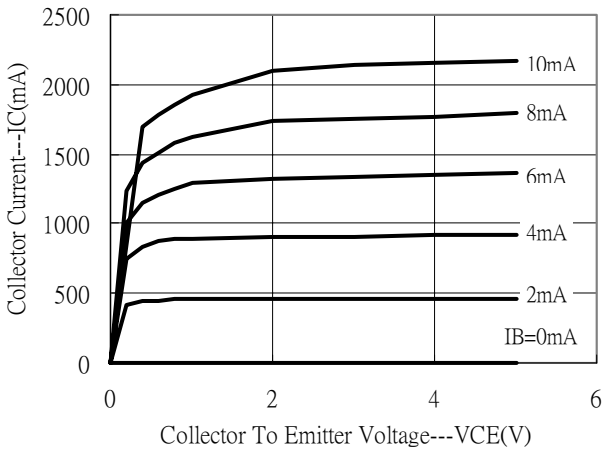

Grounded Emitter Output Characteristics

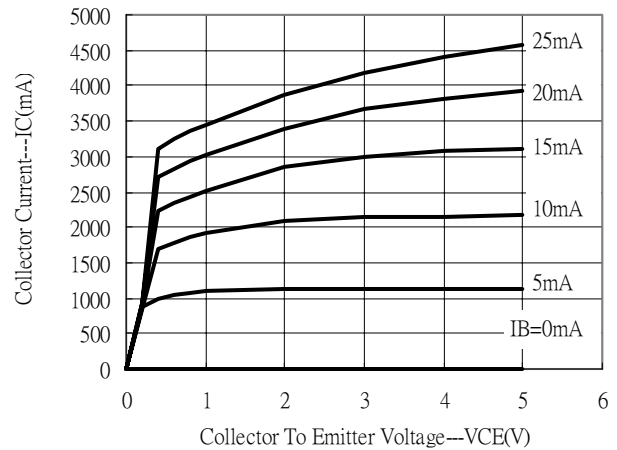

Grounded Emitter Output Characteristics

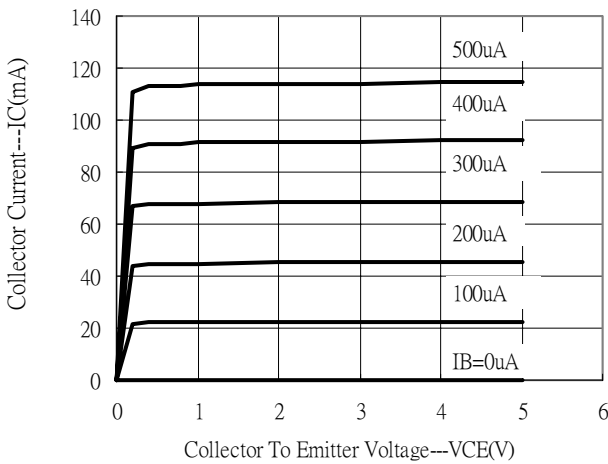

Grounded Emitter Output Characteristics

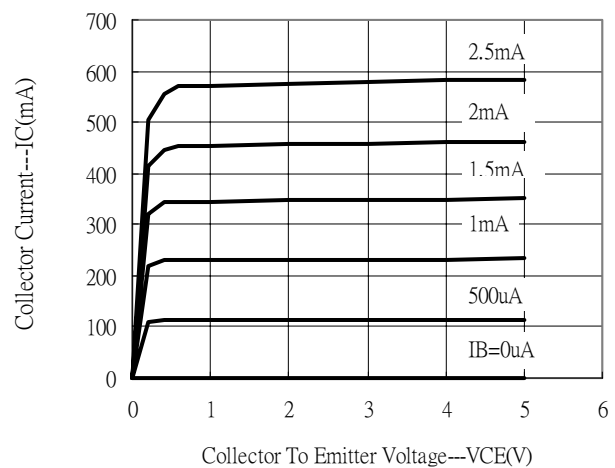

Current Gain vs Collector Current

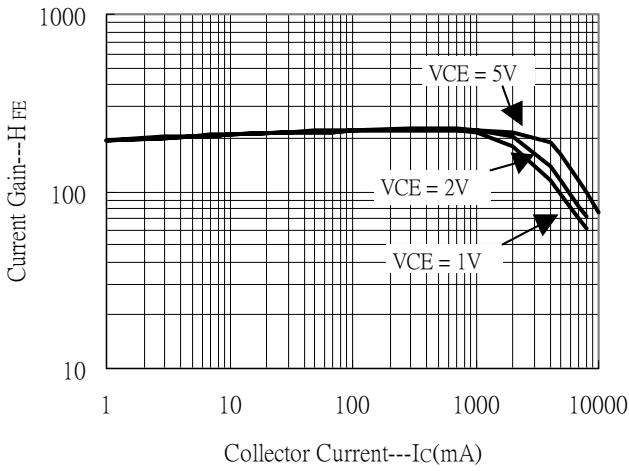

Saturation Voltage vs Collector Current

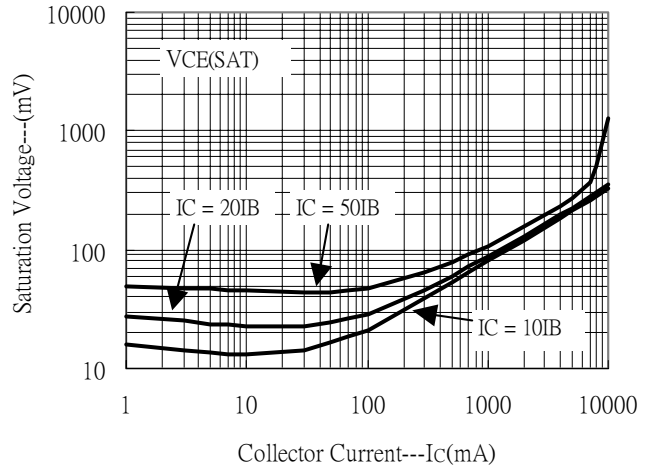

Saturation Voltage vs Collector Current

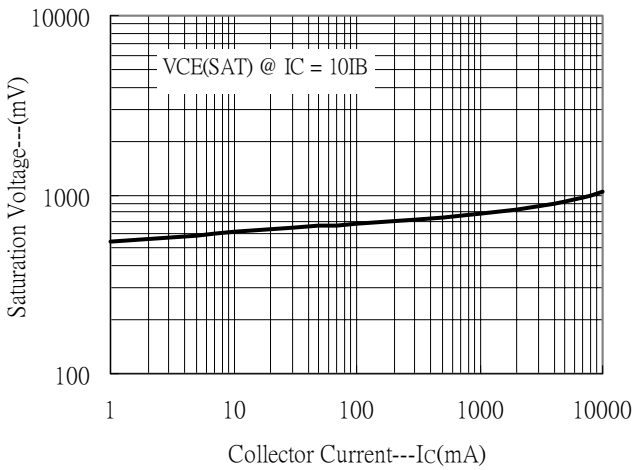

Power Derating Curve

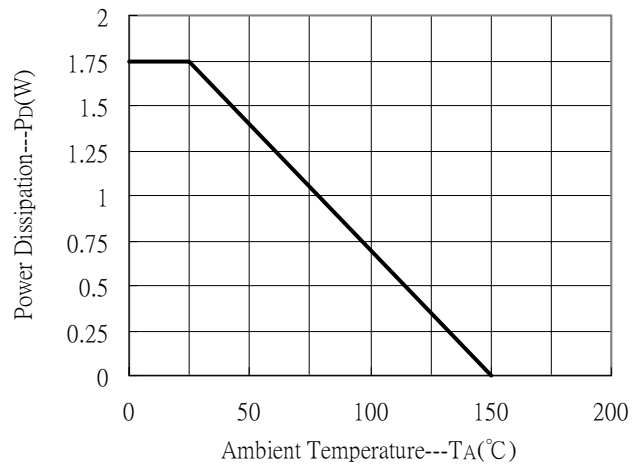

Power Derating Curve

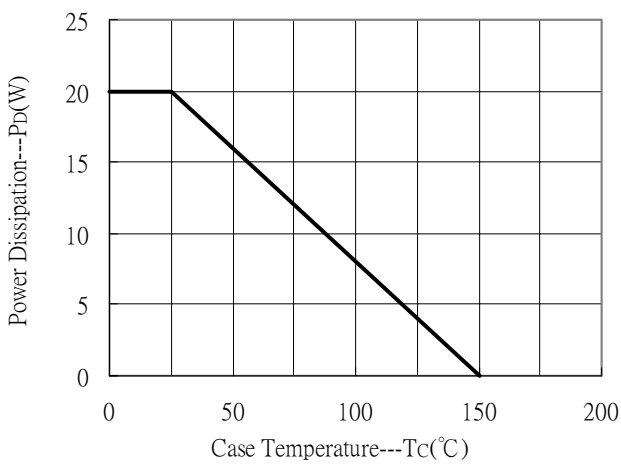

TO-252 Dimension

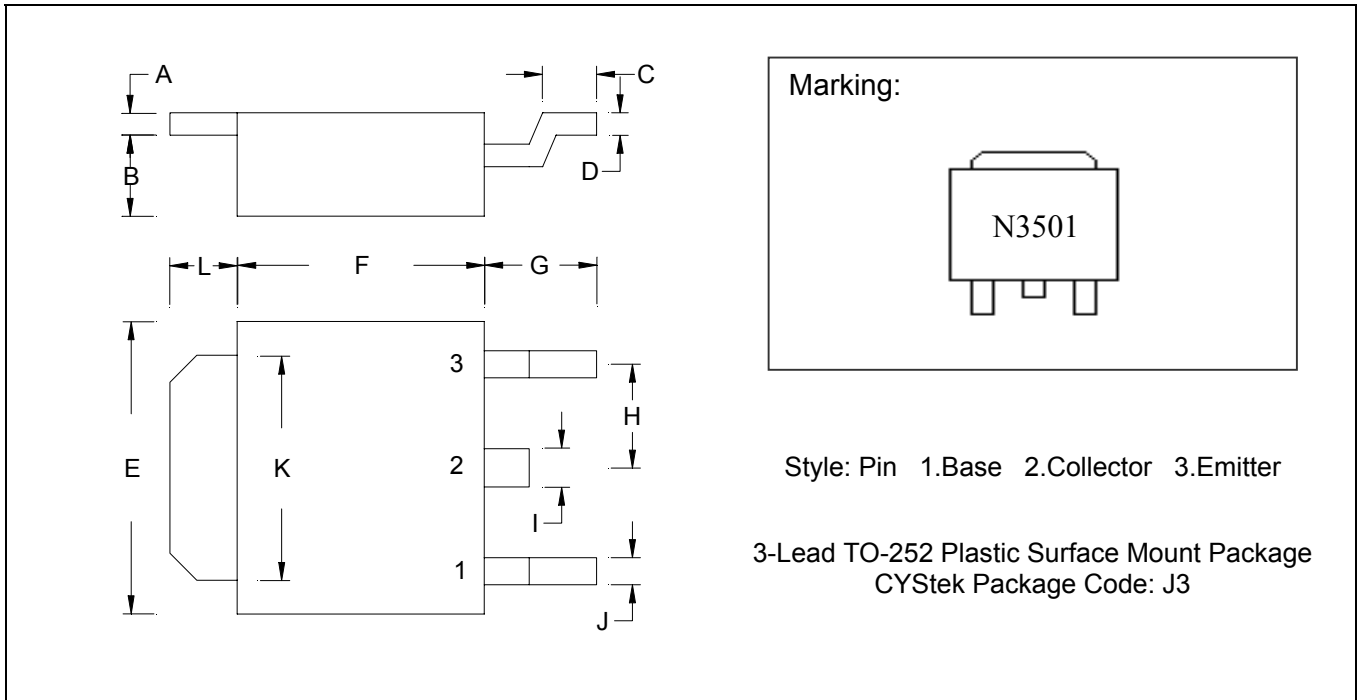

*: Typical

DIM	Inches		Millimeters		DIM	Inches		Millimeters	
	Min.	Max.	Min.	Max.		Min.	Max.	Min.	Max.
A	0.0177	0.0217	0.45	0.55	G	0.0866	0.1102	2.20	2.80
B	0.0650	0.0768	1.65	1.95	H	-	*0.0906	-	*2.30
C	0.0354	0.0591	0.90	1.50	I	-	0.0354	-	0.90
D	0.0177	0.0236	0.45	0.60	J	-	0.0315	-	0.80
E	0.2520	0.2677	6.40	6.80	K	0.2047	0.2165	5.20	5.50
F	0.2125	0.2283	5.40	5.80	L	0.0551	0.0630	1.40	1.60

Notes: 1.Controlling dimension: millimeters.
 2.Maximum lead thickness includes lead finish thickness, and minimum lead thickness is the minimum thickness of base material.
 3.If there is any question with packing specification or packing method, please contact your local CYStek sales office.

Material:

- Lead: 42 Alloy; solder plating
- Mold Compound: Epoxy resin family, flammability solid burning class: UL94V-0

Important Notice:

- All rights are reserved. Reproduction in whole or in part is prohibited without the prior written approval of CYStek.
- CYStek reserves the right to make changes to its products without notice.
- CYStek **semiconductor products are not warranted to be suitable for use in Life-Support Applications, or systems.**
- CYStek assumes no liability for any consequence of customer product design, infringement of patents, or application assistance.