

### Features

- Guard Ring Die Construction for Transient Protection
- Low Power Loss, High Efficiency
- High Surge Capability
- High Maximum Junction Temperature Rating
- Very Low Forward Voltage Drop
- Very Low Leakage Current
- For Use in Low Voltage, High Frequency Inverters, Free Wheeling, and Polarity Protection Applications
- Plastic Material: UL Flammability Classification Rating 94V-0

### Mechanical Data

- Case: DPAK Molded Plastic
- Terminals: Solderable per MIL-STD-202, Method 208
- Polarity: See Diagram
- Marking Information: See Page 2
- Weight: 0.4 grams (approx.)

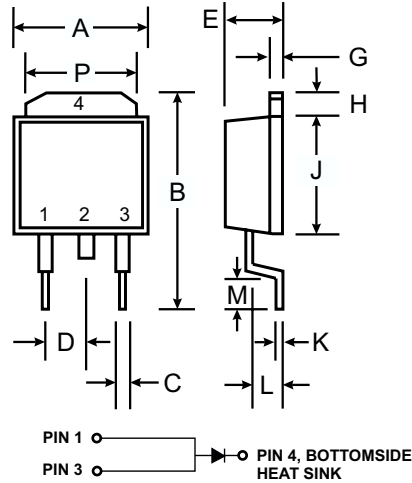

Note: Pins 1 & 3 must be electrically connected at the printed circuit board.

| DPAK                 |             |     |
|----------------------|-------------|-----|
| Dim                  | Min         | Max |
| A                    | 6.3         | 6.7 |
| B                    | —           | 10  |
| C                    | 0.3         | 0.8 |
| D                    | 2.3 Nominal |     |
| E                    | 2.1         | 2.5 |
| G                    | 0.4         | 0.6 |
| H                    | 1.2         | 1.6 |
| J                    | 5.3         | 5.7 |
| K                    | 0.5 Nominal |     |
| L                    | 1.3         | 1.8 |
| M                    | 1.0         | —   |
| P                    | 5.1         | 5.5 |
| All Dimensions in mm |             |     |

### Maximum Ratings @ T<sub>A</sub> = 25°C unless otherwise specified

Single phase, half wave, 60Hz, resistive or inductive load.  
For capacitive load, derate current by 20%.

| Characteristic  | Symbol   | Value       | Unit |
|---|--|-------------|------|
| Peak Repetitive Reverse Voltage<br>Working Peak Reverse Voltage<br>DC Blocking Voltage                                | V <sub>RRM</sub><br>V <sub>RWM</sub><br>V <sub>R</sub> | 40          | V    |
| RMS Reverse Voltage   | V <sub>R(RMS)</sub>                                    | 28          | V    |
| Average Rectified Output Current (Also see Figure 4)  | I <sub>O</sub>   | 10          | A    |
| Non-Repetitive Peak Forward Surge Current<br>8.3ms Single half sine-wave Superimposed on Rated Load<br>(JEDEC Method) | I <sub>FSM</sub>                                       | 100         | A    |
| Typical Thermal Resistance Junction to Case   | R <sub>θJC</sub>                                       | 6.0         | °C/W |
| Typical Thermal Resistance Junction to Ambient  | R <sub>θJA</sub>                                       | 80          | °C/W |
| Operating Temperature Range   | T <sub>j</sub>   | -65 to +150 | °C   |
| Storage Temperature Range   | T <sub>STG</sub>                                       | -65 to +150 | °C   |

### Electrical Characteristics @ T<sub>A</sub> = 25°C unless otherwise specified

| Characteristic                     | Symbol             | Min | Typ               | Max                  | Unit | Test Condition   |
|------------------------------------|--------------------|-----|-------------------|----------------------|------|--|
| Reverse Breakdown Voltage (Note 1) | V <sub>(BR)R</sub> | 40  | —                 | —                    | V    | I <sub>R</sub> = 1mA   |
| Forward Voltage (Note 1)           | V <sub>FM</sub>    | —   | 0.45<br>—<br>0.47 | 0.49<br>0.41<br>0.51 | V    | I <sub>F</sub> = 8A, T <sub>S</sub> = 25°C<br>I <sub>F</sub> = 8A, T <sub>S</sub> = 125°C<br>I <sub>F</sub> = 10A, T <sub>S</sub> = 25°C |
| Peak Reverse Current (Note 1)      | I <sub>RM</sub>    | —   | 0.1<br>—<br>12.5  | 0.3<br>—<br>25       | mA   | T <sub>S</sub> = 25°C, V <sub>R</sub> = 35V<br>T <sub>S</sub> = 100°C, V <sub>R</sub> = 35V  |
| Junction Capacitance               | C <sub>j</sub>     | —   | 700               | —                    | pF   | f = 1.0MHz, V <sub>R</sub> = 4.0V DC   |

Notes: 1. Short duration test pulse used to minimize self-heating effect.

**Ordering Information** (Note 2)

| Device     | Packaging | Shipping         |
|------------|-----------|------------------|
| MBRD1040-T | DPAK      | 2500/Tape & Reel |

Notes: 2. For Packaging Details, go to our website at <http://www.diodes.com/datasheets/ap02007.pdf>.

**Marking Information**

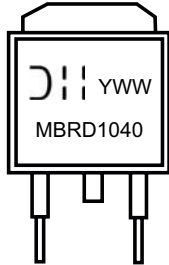

MBRD1040 = Product type marking code  
 D = Manufacturers' code marking  
 YWW = Date code marking  
 Y = Last digit of year ex: 2 for 2002  
 WW = Week code 01 to 52

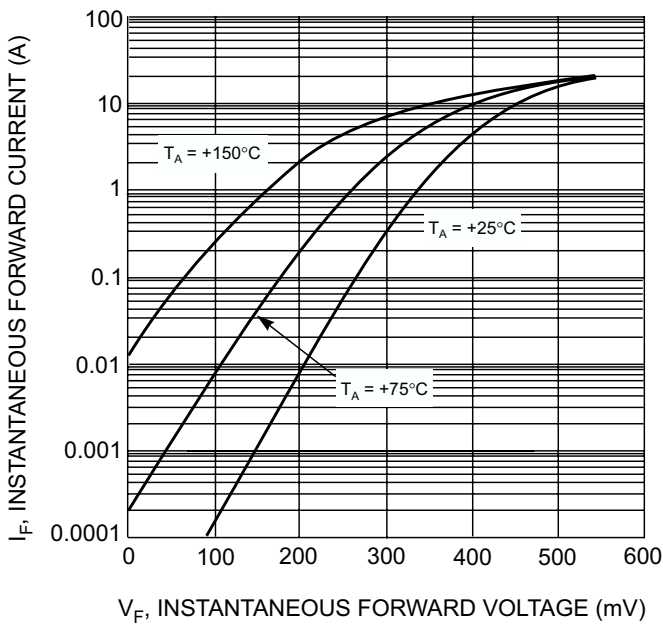

Fig. 1 Typical Forward Characteristics

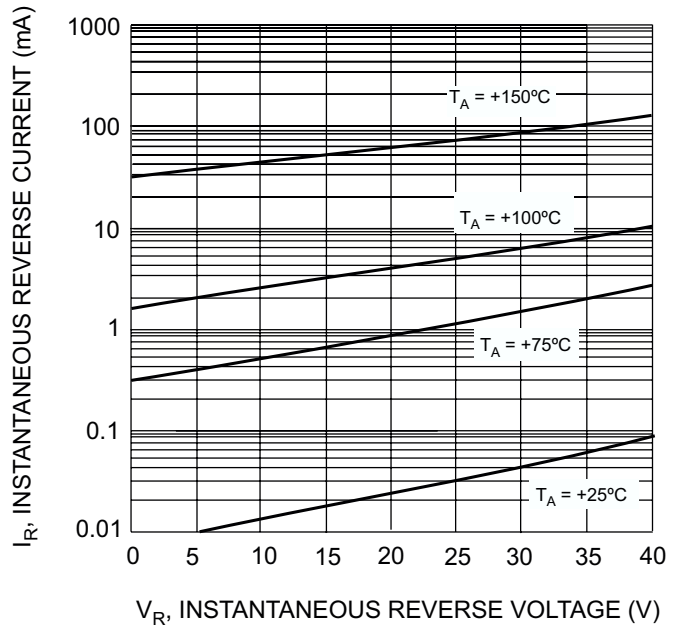

Fig. 2 Typical Reverse Characteristics

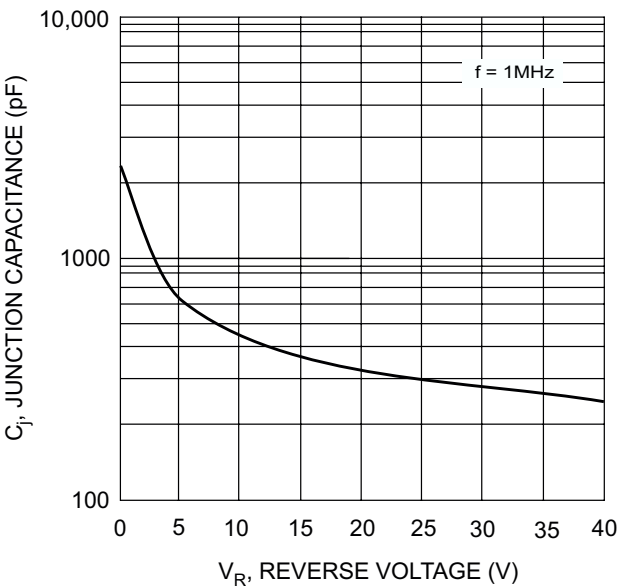

Fig. 3 Typical Junction Capacitance vs. Reverse Voltage

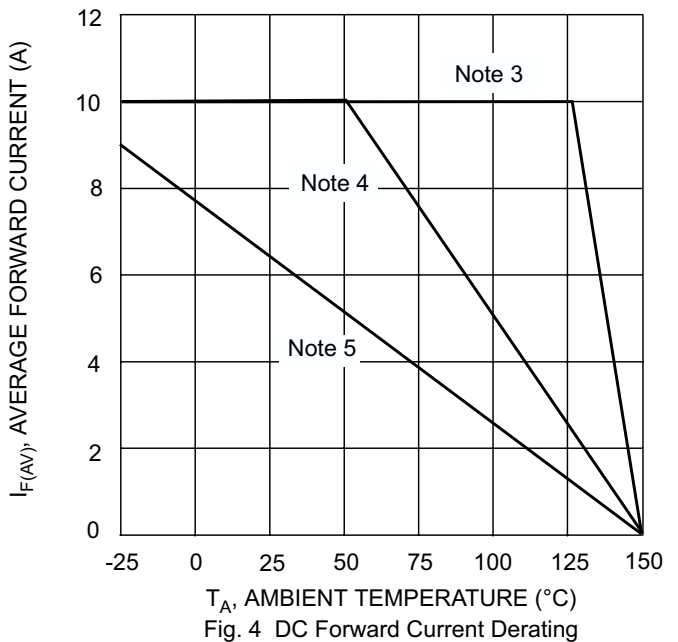
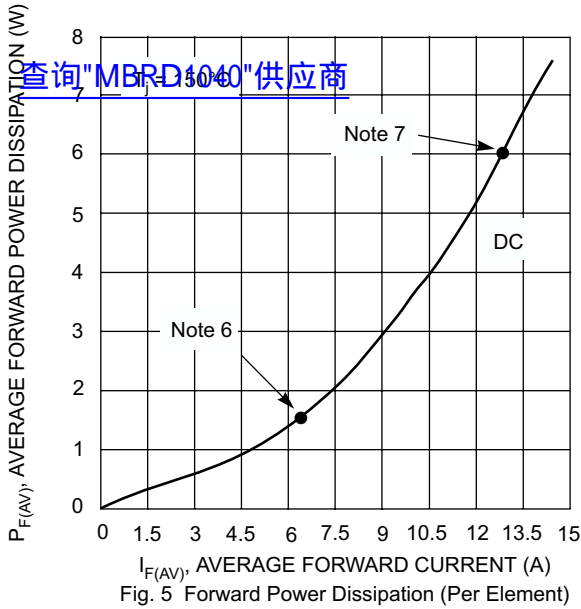

Fig. 4 DC Forward Current Derating



- Notes:
3.  $T_A = T_{\text{SOLDERING POINT}}$ ,  $R_{\theta JC} = 6.0^{\circ}\text{C/W}$ ,  $R_{\theta CA} = 0^{\circ}\text{C/W}$ .
  4. Device mounted on GETEK substrate, 2"x2", 2 oz. copper, double-sided, cathode pad dimensions 0.75" x 1.0", anode pad dimensions 0.25" x 1.0".  $R_{\theta JA}$  in range of 15-30°C/W.
  5. Device mounted on FR-4 substrate, 2"x2", 2 oz. copper, single-sided, pad layout as per Diodes Inc. suggested pad layout document AP02001 which can be found on our website at <http://www.diodes.com/datasheets/ap02001.pdf>.  $R_{\theta JA}$  in range of 60-75°C/W.
  6. Maximum power dissipation when the device is mounted in accordance to the conditions described in Note 5.
  7. Maximum power dissipation when the device is mounted in accordance to the conditions described in Note 4.