



Control over power

Series CS

10-90Amp • 120/240 Vac • AC OUTPUT

- Low Leakage
- SCR Output
- Panel Mount
- Zero Voltage Switching

The Series CS has an SCR AC switch output featuring low off-state leakage (1mA, snubberless), zero-voltage switching and a broadened operating range (24-280Vac). This wide range permits optimum performance at both 120Vac and 240Vac line voltages.

Manufactured in Crydom's ISO 9001 Certified facility for optimum product performance and reliability.

| MODEL NUMBERS | CSD2410 CSE2410 | CSD2425 CSE2425 | CSD2450 CSE2450 | CSD2475 CSE2475 | CSD2490 CSE2490 |
|---|--------------------|--------------------|--------------------|--------------------|--------------------|
| OUTPUT SPECIFICATIONS^① | | | | | |
| Operating Voltage (47-63 Hz) [Vrms] | 24-280 | 24-280 | 24-280 | 24-280 | 24-280 |
| Load Current Range ^③ [Arms] | 0.15-10 | 0.15-25 | 0.15-50 | 0.25-75 | 0.25-90 |
| Transient Overvoltage [Vpk] | 600 | 600 | 600 | 600 | 600 |
| Max. Surge Current, (16.6ms) [Apk] | 120 | 250 | 625 | 1000 | 1200 |
| Max. On-State Voltage Drop @ Rated Current [Vpk] | 1.6 | 1.6 | 1.6 | 1.6 | 1.6 |
| Thermal Resistance Junction to Case (R _{θJC}) [°C/W] | 1.48 | 1.02 | 0.63 | 0.31 | 0.28 |
| Maximum I ² t for Fusing, (8.3 msec.) [A ² sec] | 60 | 260 | 1620 | 4150 | 6000 |
| Max. Off-State Leakage Current @ Rated Voltage [mA] | 1.0 | 1.0 | 1.0 | 1.0 | 1.0 |
| Min. Off-State dv/dt @ Max. Rated Voltage [V/μsec] ^② | 500 | 500 | 500 | 500 | 500 |
| Max. Turn-On Time | 1/2 Cycle | 1/2 Cycle | 1/2 Cycle | 1/2 Cycle | 1/2 Cycle |
| Max. Turn-Off Time | 1/2 Cycle | 1/2 Cycle | 1/2 Cycle | 1/2 Cycle | 1/2 Cycle |
| Power Factor (Min.) with Max. Load | 0.5 | 0.5 | 0.5 | 0.5 | 0.5 |

INPUT SPECIFICATIONS^①

| | DC CONTROL (CSD PREFIX) | DC CONTROL (CSE PREFIX) |
|-------------------------|----------------------------|----------------------------|
| Control Voltage Range | 3.5-15 Vdc | 15-32 Vdc |
| Max. Turn-On Voltage | 3.5 Vdc | 15.0 Vdc |
| Min. Turn-Off Voltage | 1.0 Vdc | 1.0 Vdc |
| Nominal Input Impedence | 300 Ohm | 2k Ohm |
| Typical Input Current | 15 mA @ 5 Vdc | 7mA @ 15 V |

GENERAL NOTES

© 2001 CRYDOM CORP, Specifications subject to change without notice.

- ① All parameters at 25°C unless otherwise specified.
- ② Off-State dv/dt test method per EIA/NARM standard RS-443, paragraph 13.11.1
- ③ Heat sinking required, for derating curves see page 2.

For recommended applications and more information contact:
USA: Sales Support (877) 502-5500 **Tech Support** (877) 702-7700 **FAX** (619) 710-8540
 Crydom Corp, 2320 Paseo de las Americas, Ste. 201, San Diego, CA 92154
Email: sales@crydom.com **WEB SITE:** http://www.crydom.com
UK: +44 (0)1202 365070 • **FAX** +44 (0)1202 365090 Crydom International Ltd., 7 Cobham
 Road, Ferndown Industrial Estate, Ferndown, Dorset BH21 7PE, **Email:** intsales@crydom.com.
GERMANY: +49 (0)180 3000 506

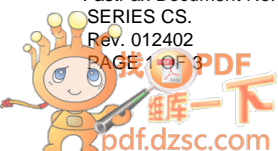

Series CS

10-90Amp • 120/240 Vac • AC OUTPUT



GENERAL SPECIFICATIONS

| | |
|---|---------------------|
| Dielectric Strength 50/60Hz , Input/Output/Base | 4000 Vrms |
| Insulation Resistance (Min.) @ 500 Vdc | 10 ⁹ Ohm |
| Max. Capacitance Input/Output | 10 pF |
| Ambient Operating Temperature Range | -40 to 80°C |
| Ambient Storage Temperature Range | -40 to 125°C |

MECHANICAL SPECIFICATIONS

| | |
|-------------------|---|
| Weight: (typical) | 3.0 oz. (86.5g) |
| Encapsulation: | Thermally Conductive Epoxy |
| Terminals: | Screws and Saddle Clamps Furnished, Unmounted |

AVAILABLE OPTIONS

- F** Faston Terminals (Up to 50A Models)
Example: **CSD2425F**
- G** Input Status LED.
Agencies Approval Pending
Example: **CSD2425G**
Note: Control Voltage Range 5-15Vdc for CSD Models.
- P** Internal Overvoltage Protection.
Relay Will Self Trigger Between 450-600 Vpk. Not Suitable For Capacitive Loads.
Agencies Approval Pending.
Example: **CSD2425P**
- 10** Random Turn-On (AC & DC Control)
Phase Controllable (DC Control)
Example: **CSD2425-10**

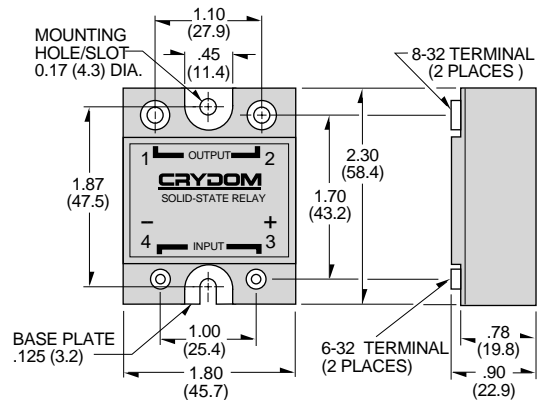

Screw Torque Requirements:
6-32 Screws - 10 in./lbs.,
8-32 and 10-32 Screws - 20in./lbs.
(Screws dry without grease.)

Fastons:
Single pair (up to 25A)
Double pair* (up to 50A).
* Caution: User must connect to both pairs

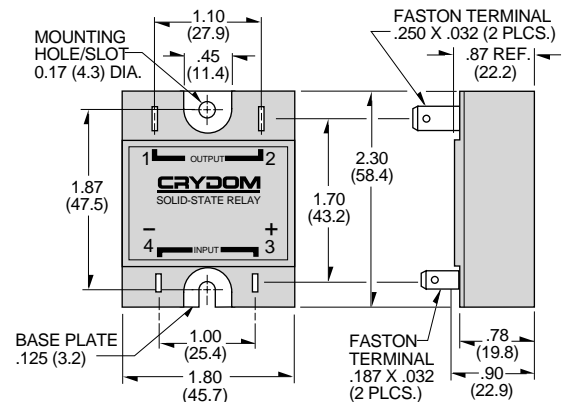

Crydom Heat Sinks offer excellent thermal management and are perfectly matched to the load current ratings of Crydom panel mount relays. Request Crydom's Heat Sink specification sheet for all the details.

All dimensions are in inches (millimeters)

APPROVALS

UL E116949
CSA LR81689
VDE 10143 UG



查询"CSD2410"供应商

Series CS

10-90Amp • 120/240 Vac • AC OUTPUT

CRYDOM

Control over power

CURRENT DERATING CURVES

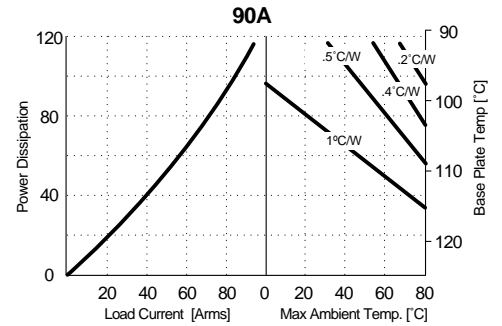
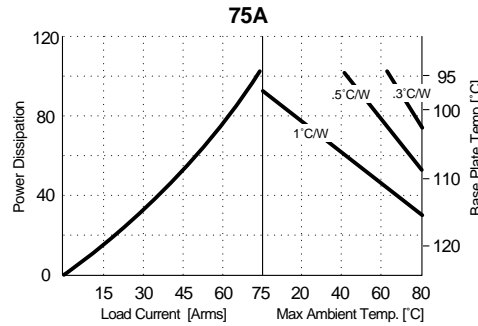
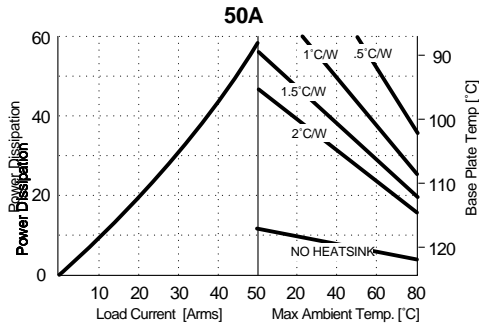
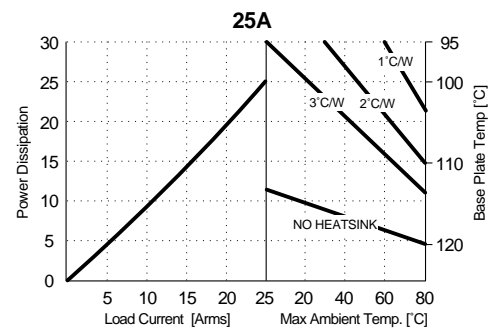
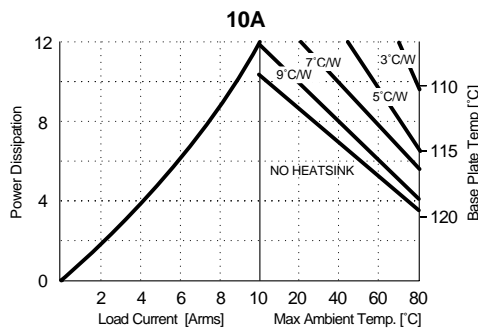

© 2001 CRYDOM CORP, Specifications subject to change without notice.

For recommended applications and more information contact:

USA: Sales Support (877) 502-5500 **Tech Support** (877) 702-7700 **FAX** (619) 710-8540

Crydom Corp, 2320 Paseo de las Americas, Ste. 201, San Diego, CA 92154

Email: sales@crydom.com **WEB SITE:** <http://www.crydom.com>

UK: +44 (0)1202 365070 • **FAX** +44 (0)1202 365090 Crydom International Ltd., 7 Cobham

Road, Ferndown Industrial Estate, Ferndown, Dorset BH21 7PE, **Email:** intsales@crydom.com.

GERMANY: +49 (0)180 3000 506

