

LM48411 Boomer® Audio Power Amplifier Series

Ultra-Low EMI, Filterless, 2.5W, Stereo, Class D Audio Power Amplifier with E²S

General Description

The LM48411 is a single supply, high efficiency, 2.5W/channel Class D audio amplifier. The LM48411 features National's Enhanced Emissions Suppression (E²S) system, that features a unique patent-pending ultra low EMI, spread spectrum, PWM architecture, that significantly reduces RF emissions while preserving audio quality and efficiency. The E²S system improves battery life, reduces external component count, board area consumption, system cost, and simplifying design.

The LM48411 is designed to meet the demands of mobile phones and other portable communication devices. Operating on a single 5V supply, it is capable of delivering 2.5W/channel of continuous output power to a 4Ω load with less than 10% THD+N. Its flexible power supply requirements allow operation from 2.4V to 5.5V. The wide band spread spectrum architecture of the LM48411 reduces EMI-radiated emissions due to the modulator frequency.

The LM48411 features high efficiency compared to a conventional Class AB amplifier. The E²S system includes an advanced, patent-pending edge rate control (ERC) architecture that further reduce emissions by minimizing the high frequency component of the device output, while maintaining high quality audio reproduction and high efficiency ($\eta = 87\%$ at $V_{DD} = 3.6V$, $P_O = 500mW$). Four gain options are pin selectable through GAIN0 and GAIN1 pins.

The LM48411 features a low-power consumption shutdown mode. Shutdown may be enabled by driving the Shutdown pin to a logic low (GND).

Output short circuit protection prevents the device from being damaged during fault conditions. Superior click and pop suppression eliminates audible transients on power up/down and during shutdown. Independent left/right shutdown control maximizes power savings in mixed mono/stereo applications.

Key Specifications

| | |
|--|--------------|
| ■ Efficiency at 3.6V, 500mW into 8Ω speaker | 87% (typ) |
| ■ Efficiency at 3.6V, 100mW into 8Ω speaker | 80% (typ) |
| ■ Efficiency at 5V, 1W into 8Ω speaker | 88% (typ) |
| ■ Quiescent current, 3.6V supply | 4.2mA (typ) |
| ■ Power Output at $V_{DD} = 5V$ $R_L = 4\Omega$, THD $\leq 10\%$ | 2.5W (typ) |
| ■ Power Output at $V_{DD} = 5V$ $R_L = 8\Omega$, THD $\leq 10\%$ | 1.5W (typ) |
| ■ Total shutdown power supply current | 0.01μA (typ) |
| ■ Single supply range | 2.4V to 5.5V |

Features

- E²S system reduces EMI preserving Audio Quality and Efficiency
- Output short circuit protection
- Stereo Class D Operation
- No output filter required for inductive loads
- Logic selectable gain
- Independent shutdown control
- Minimum external components
- "Click and pop" suppression circuitry
- Micro-power shutdown mode
- Available in space-saving 0.5mm pitch micro SMD package

Applications

- Mobile phones
- PDAs
- Portable electronic devices

LM48411 Rf Emissions

[查询"LM48411TL"供应商](#)

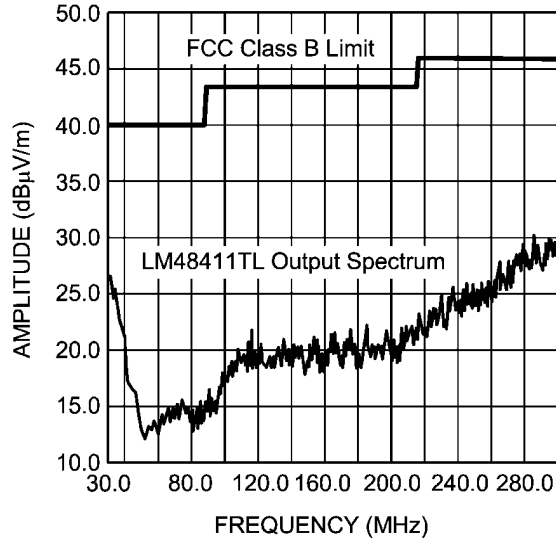

30009586

Typical Application

[查询"LM48411TL"供应商](#)

LM48411

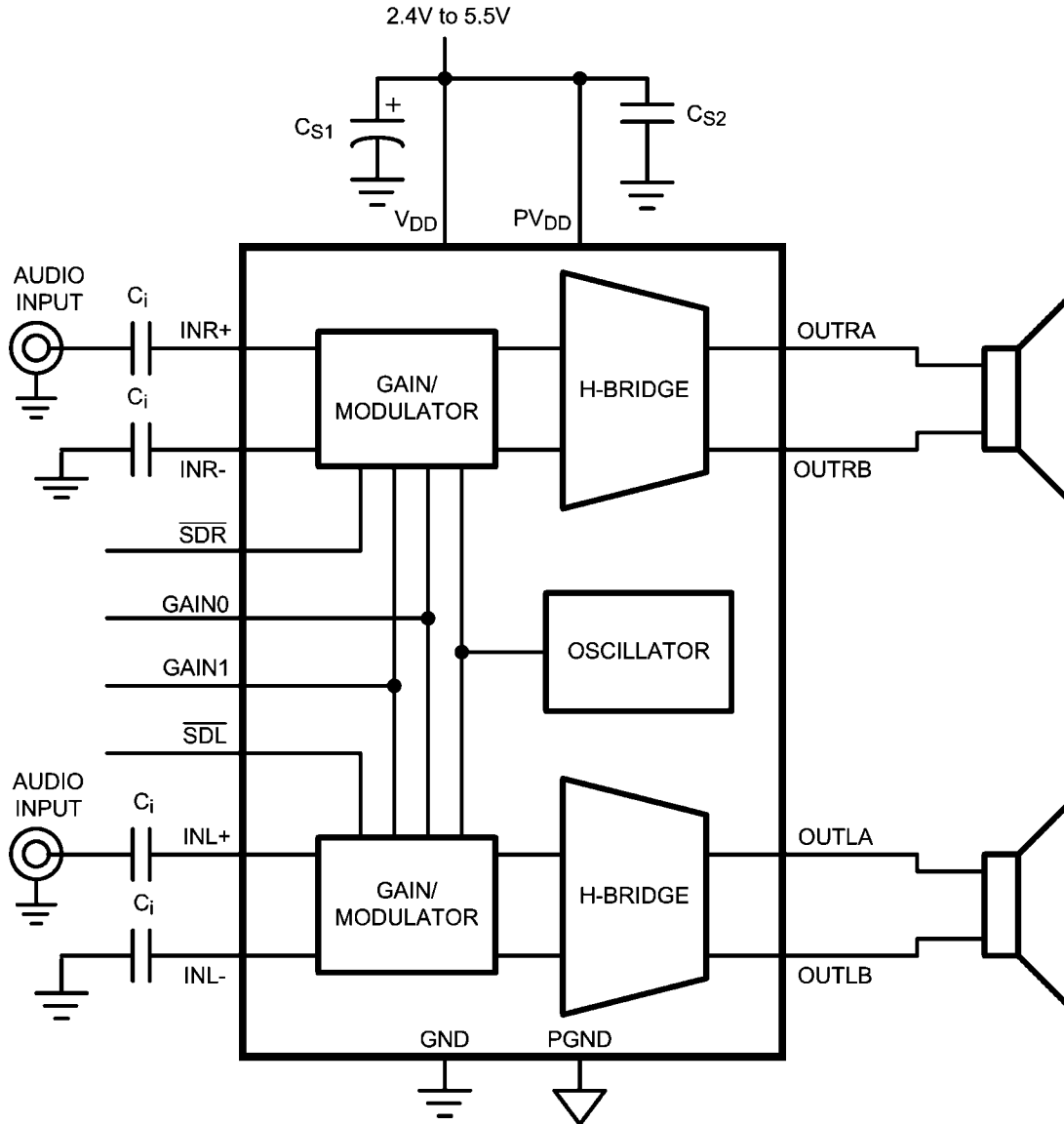

30009501

FIGURE 1. Typical Audio Amplifier Application Circuit

Connection Diagrams

[查询 LM48411TL 引脚图](#)

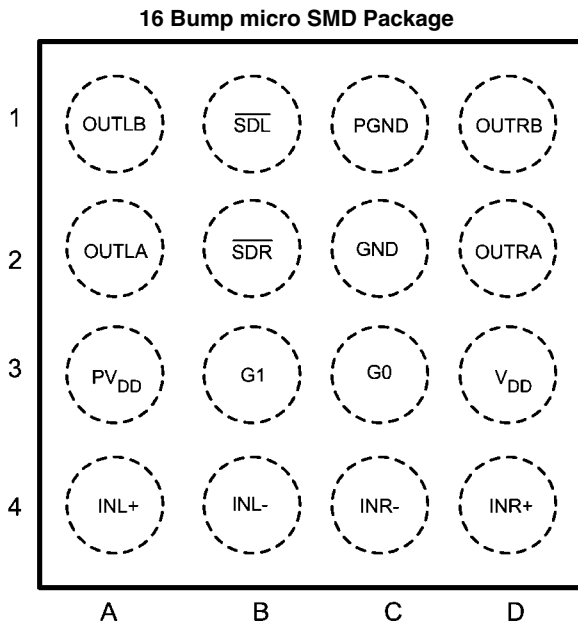

Top View
Order Number LM48411TL
See NS Package Number TLA16ACA

30009502

micro SMD Marking

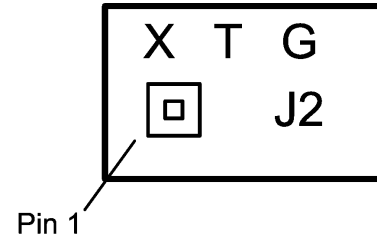

Top View
X — Date Code
T — Die Traceability
G — Boomer Family
J2 — LM48411TL

30009557

Pin Descriptions

| Bump | Name | Function |
|------|------------------|-----------------------------------|
| A1 | OUTLB | Left Channel output B |
| A2 | OUTLA | Left Channel output A |
| A3 | PV _{DD} | Power V _{DD} |
| A4 | INL+ | Non-inverting left channel input |
| B1 | SDL | Left channel active low shutdown |
| B2 | SDR | Right channel active low shutdown |
| B3 | G1 | Gain setting input 1 |
| B4 | INL- | Inverting left channel input |
| C1 | PGND | Power ground |
| C2 | GND | Ground |
| C3 | G0 | Gain setting input 0 |
| C4 | INR- | Inverting right channel input |
| D1 | OUTRB | Right channel output B |
| D2 | OUTRA | Right channel output A |
| D3 | V _{DD} | Power Supply |
| D4 | INR+ | Non-inverting right channel input |

Absolute Maximum Ratings (Notes 1, 2)

查询"LM48411TL"供应商
If Military/Aerospace specified devices are required, please contact the National Semiconductor Sales Office/Distributors for availability and specifications.

| | |
|-------------------------------------|--|
| Supply Voltage (Note 1) | 6.0V |
| Storage Temperature | -65°C to +150°C |
| Voltage at Any Input Pin | $V_{DD} + 0.3V \geq V \geq GND - 0.3V$ |
| Power Dissipation (Note 3) | Internally Limited |
| ESD Rating, all other pins (Note 4) | 2.0kV |
| ESD Rating (Note 5) | 200V |
| Junction Temperature (T_{JMAX}) | 150°C |

Thermal Resistance

 θ_{JA} (micro SMD)

63.6°C/W

Soldering Information

See AN-1112 "microSMD Wafers Level Chip Scale Package."

Operating Ratings (Notes 1, 2)

Temperature Range

 $T_{MIN} \leq T_A \leq T_{MAX}$ $-40^\circ\text{C} \leq T_A \leq 85^\circ\text{C}$

Supply Voltage

 $2.4V \leq V_{DD} \leq 5.5V$

Electrical Characteristics The following specifications apply for $A_V = 6\text{dB}$, $R_L = 15\mu\text{H} + 8\Omega$, $f = 1\text{kHz}$, unless otherwise specified. Limits apply for $T_A = 25^\circ\text{C}$. $V_{DD} = 3.6\text{V}$.

| Symbol | Parameter | Conditions | LM48411 | | Units (Limits) |
|------------|------------------------------------|--|----------|--------------|---------------------|
| | | | Typical | Limit | |
| | | | (Note 6) | (Notes 7, 8) | |
| $ V_{OS} $ | Differential Output Offset Voltage | $V_I = 0V$, $A_V = 2V/V$, $V_{DD} = 2.4V$ to $5.0V$ | 5 | | mV |
| I_{DD} | Quiescent Power Supply Current | $V_{IN} = 0V$, No Load, $V_{DD} = 5.0V$ | 5.1 | 7.5 | mA (max) |
| | | $V_{IN} = 0V$, No Load, $V_{DD} = 3.6V$ | 4.2 | 6.0 | mA (max) |
| | | $V_{IN} = 0V$, No Load, $V_{DD} = 2.4V$ | 3.0 | 4.5 | mA (max) |
| | | $V_{IN} = 0V$, $R_L = 8\Omega$, $V_{DD} = 5.0V$ | 5.2 | | mA |
| | | $V_{IN} = 0V$, $R_L = 8\Omega$, $V_{DD} = 3.6V$ | 4.2 | | mA |
| | | $V_{IN} = 0V$, $R_L = 8\Omega$, $V_{DD} = 2.4V$ | 3.0 | | mA |
| I_{SD} | Shutdown Current | $V_{SDR} = V_{SDL} = GND$ | 0.01 | 1.0 | μA (max) |
| V_{SDIH} | Shutdown voltage input high | For SDR, SDL | | 1.4 | V (min) |
| V_{SDIL} | Shutdown voltage input low | For SDR, SDL | | 0.4 | V (max) |
| A_V | Gain | GAIN0, GAIN1 = GND $R_L = \infty$ | 6 | 6 ± 0.5 | dB |
| | | GAIN0 = V_{DD} , GAIN1 = GND $R_L = \infty$ | 12 | 12 ± 0.5 | dB |
| | | GAIN0 = GND, GAIN1 = V_{DD} $R_L = \infty$ | 18 | 18 ± 0.5 | dB |
| | | GAIN0, GAIN1 = V_{DD} $R_L = \infty$ | 24 | 24 ± 0.5 | dB |
| R_{IN} | Input Resistance | $A_V = 6\text{dB}$ | 56 | | $\text{k}\Omega$ |
| | | $A_V = 12\text{dB}$ | 37.5 | | $\text{k}\Omega$ |
| | | $A_V = 18\text{dB}$ | 22.5 | | $\text{k}\Omega$ |
| | | $A_V = 24\text{dB}$ | 12.5 | | $\text{k}\Omega$ |

| Symbol | Parameter | Conditions | LM48411 | | Units (Limits) |
|------------------------|---|--|-------------------|--------------|-------------------|
| | | | Typical | Limit | |
| | | | (Note 6) | (Notes 7, 8) | |
| P _O | Output Power | R _L = 15μH + 4Ω + 15μH THD = 10% (max) f = 1kHz, 22kHz BW V _{DD} = 5V V _{DD} = 3.6V V _{DD} = 2.5V | 2.5 1.2 530 | | W W mW |
| | | R _L = 15μH + 4Ω + 15μH THD = 1% (max) f = 1kHz, 22kHz BW V _{DD} = 5V V _{DD} = 3.6V V _{DD} = 2.5V | 2.0 1.0 430 | | W W mW |
| P _O | Output Power | R _L = 15μH + 8Ω + 15μH THD = 10% (max) f = 1kHz, 22kHz BW | | | |
| | | V _{DD} = 5V | 1.5 | | W |
| | | V _{DD} = 3.6V | 760 | 600 | mW (min) |
| | | V _{DD} = 2.5V | 330 | | mW |
| | | R _L = 15μH + 8Ω + 15μH THD = 1% (max) f = 1kHz, 22kHz BW | | | |
| | | V _{DD} = 5V | 1.25 | | W |
| | | V _{DD} = 3.6V | 615 | | mW |
| V _{DD} = 2.5V | 270 | | mW | | |
| THD+N | Total Harmonic Distortion + Noise | P _O = 500mW, f = 1kHz, R _L = 8Ω | 0.05 | | % |
| | | P _O = 300mW, f = 1kHz, R _L = 8Ω | 0.03 | | % |
| PSRR | Power Supply Rejection Ratio (Input Referred) | V _{Ripple} = 200mV _{PP} Sine, f _{Ripple} = 217Hz, V _{DD} = 3.6, 5V Inputs to AC GND, C ₁ = 2μF | 78 | | dB |
| | | V _{Ripple} = 200mV _{PP} Sine, f _{Ripple} = 1kHz, V _{DD} = 3.6, 5V Inputs to AC GND, C ₁ = 2μF | 77 | | dB |
| SNR | Signal to Noise Ratio | V _{DD} = 5V, P _O = 1W _{RMS} | 96 | | dB |
| ε _{OUT} | Output Noise (Input Referred) | V _{DD} = 3.6V, A Weighted | 22 | | μV _{RMS} |
| CMRR | Common Mode Rejection Ratio (Input Referred) | V _{DD} = 3.6V, V _{Ripple} = 1V _{PP} Sine f _{Ripple} = 217Hz | 64 | | dB |
| η | Efficiency | V _{DD} = 5V, P _{OUT} = 1W R _L = 8Ω | 88 | | % |
| Xtalk | Crosstalk | P _O = 500mW, f = kHz | 84 | | dB |

Note 1: "Absolute Maximum Ratings" indicate limits beyond which damage to the device may occur, including inoperability and degradation of device reliability and/or performance. Functional operation of the device and/or non-degradation at the Absolute Maximum Ratings or other conditions beyond those indicated in the Recommended Operating Conditions is not implied. The Recommended Operating Conditions indicate conditions at which the device is functional and the device should not be operated beyond such conditions. All voltages are measured with respect to the ground pin, unless otherwise specified

Note 2: The Electrical Characteristics tables list guaranteed specifications under the listed Recommended Operating Conditions except as otherwise modified or specified by the Electrical Characteristics Conditions and/or Notes. Typical specifications are estimations only and are not guaranteed.

Note 3: The maximum power dissipation must be derated at elevated temperatures and is dictated by T_{JMAX} , θ_{JA} , and the ambient temperature, T_A . The maximum allowable power dissipation is $P_{DMAX} = (T_{JMAX} - T_A) / \theta_{JA}$ or the number given in Absolute Maximum Ratings, whichever is lower. For the LMxxxxx, see Power Derating curves for additional information.

Note 4: Human body model, applicable std. JESD22-A114C.

Note 5: Machine model, applicable std. JESD22-A115-A.

Note 6: Typical values represent most likely parametric norms at $T_A = +25^\circ\text{C}$, and at the Recommended Operation Conditions at the time of product characterization and are not guaranteed.

Note 7: Datasheet min/max specification limits are guaranteed by test or statistical analysis.

Note 8: Shutdown current is measured in a normal room environment. Exposure to direct sunlight will increase I_{SD} by a maximum of $2\mu\text{A}$. The Shutdown pin should be driven as close as possible to GND for minimal shutdown current and to V_{DD} for the best THD performance in PLAY mode. See the Application Information section under SHUTDOWN FUNCTION for more information.

Note 9: The performance graphs were taken using the Audio Precision AUX-0025 Switching Amplifier measurement Filter in series with the LC filter on the demo board.

Typical Performance Characteristics

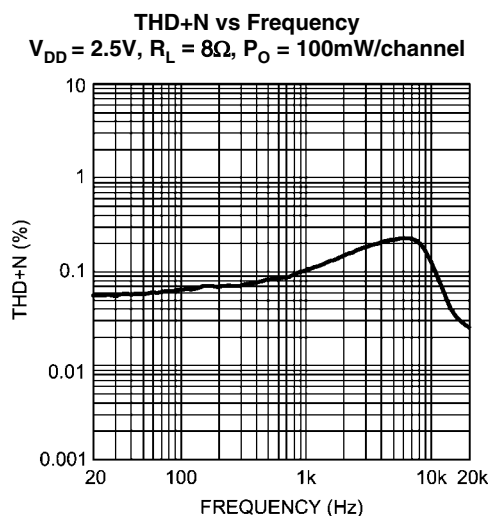

30009540

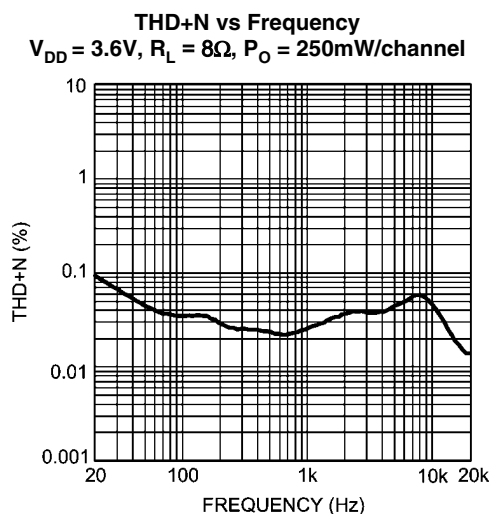

30009546

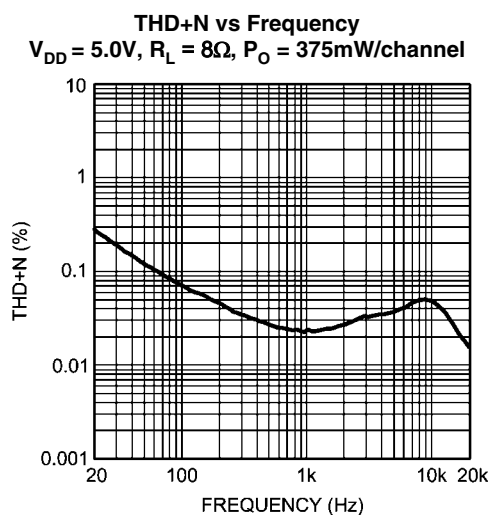

30009549

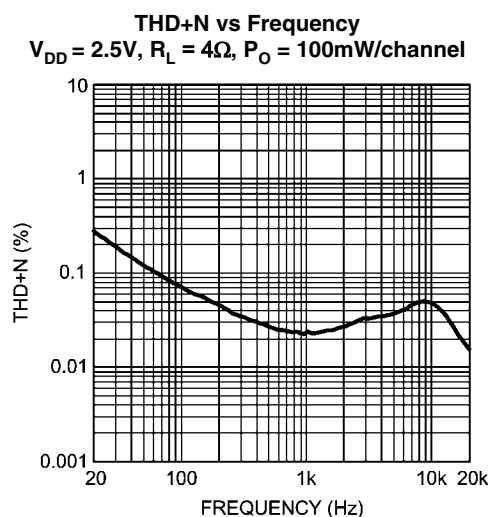

30009552

THD+N vs Frequency
 $V_{DD} = 3.6V, R_L = 8\Omega, P_O = 250mW/channel$

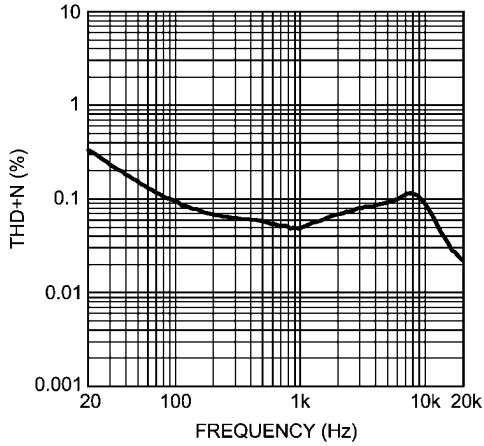

30009556

THD+N vs Frequency
 $V_{DD} = 5.0V, R_L = 4\Omega, P_O = 375mW/channel$

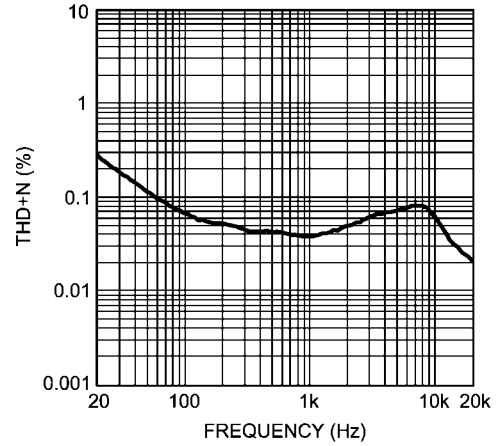

30009558

THD+N vs Output Power
 $V_{DD} = 2.5V, R_L = 8\Omega, A_V = 6dB$

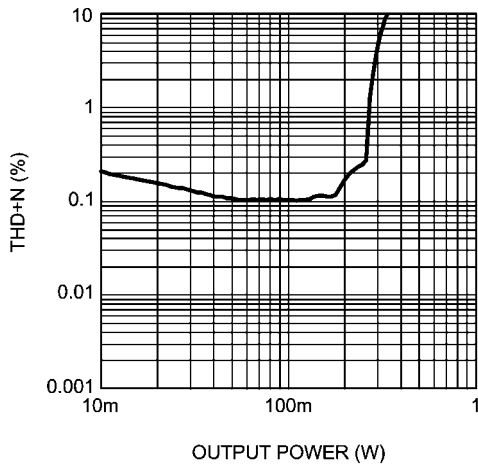

30009574

THD+N vs Output Power
 $V_{DD} = 2.5V, R_L = 8\Omega, A_V = 24dB$

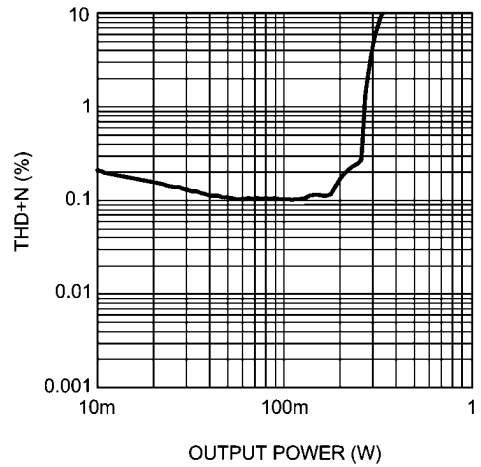

30009575

THD+N vs Output Power
 $V_{DD} = 3.6V, R_L = 8\Omega, A_V = 6dB$

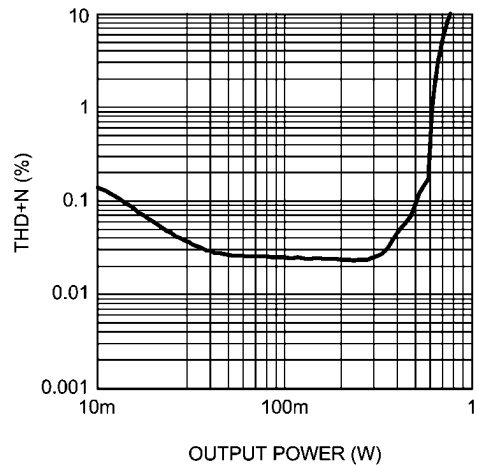

30009578

THD+N vs Output Power
 $V_{DD} = 3.6V, R_L = 8\Omega, A_V = 24dB$

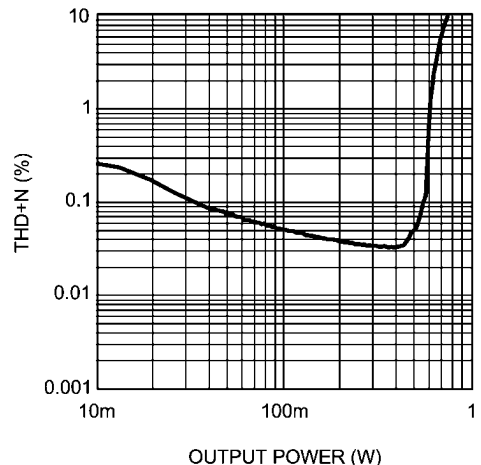

30009579

THD+N vs Output Power
 $V_{DD} = 5V, R_L = 8\Omega, A_V = 6dB$

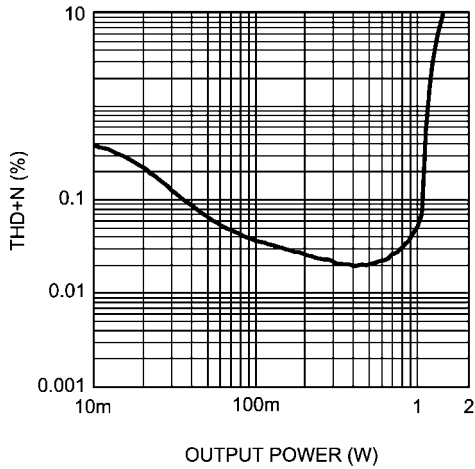

30009582

THD+N vs Output Power
 $V_{DD} = 5V, R_L = 8\Omega, A_V = 24dB$

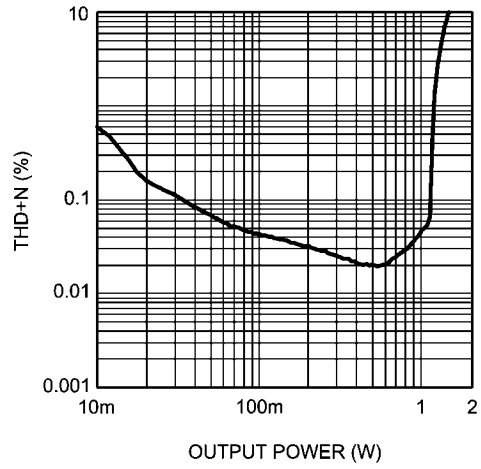

30009583

THD+N vs Output Power
 $V_{DD} = 2.5V, R_L = 4\Omega, A_V = 6dB$

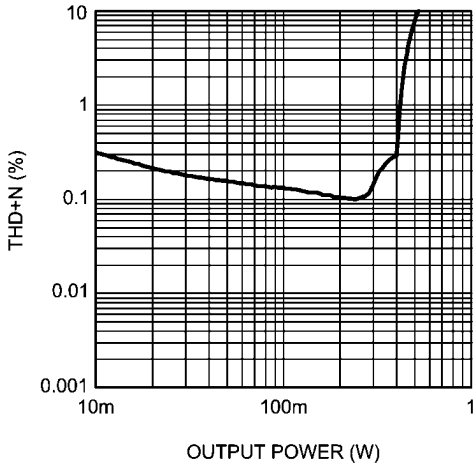

30009572

THD+N vs Output Power
 $V_{DD} = 2.5V, R_L = 4\Omega, A_V = 24dB$

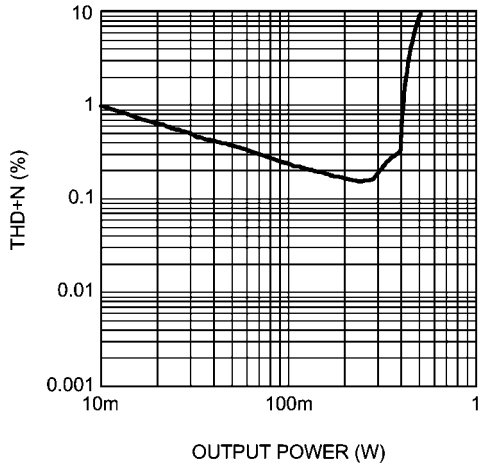

30009573

THD+N vs Output Power
 $V_{DD} = 3.6V, R_L = 4\Omega, A_V = 6dB$

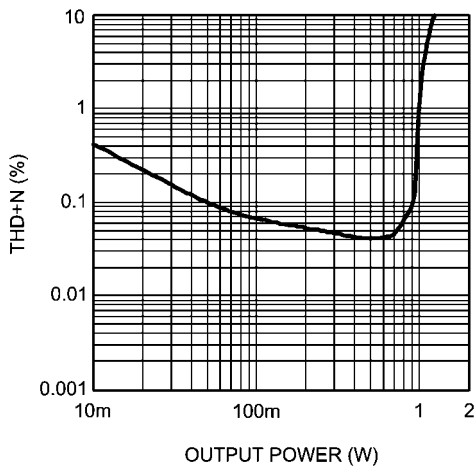

30009576

THD+N vs Output Power
 $V_{DD} = 3.6V, R_L = 4\Omega, A_V = 24dB$

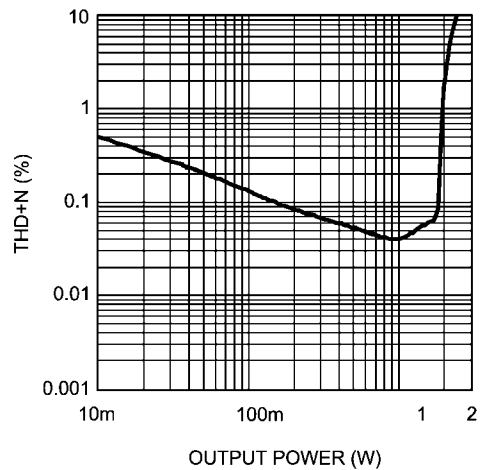

30009577

THD+N vs Output Power
 $V_{DD} = 5.0V, R_L = 4\Omega, A_V = 6dB$

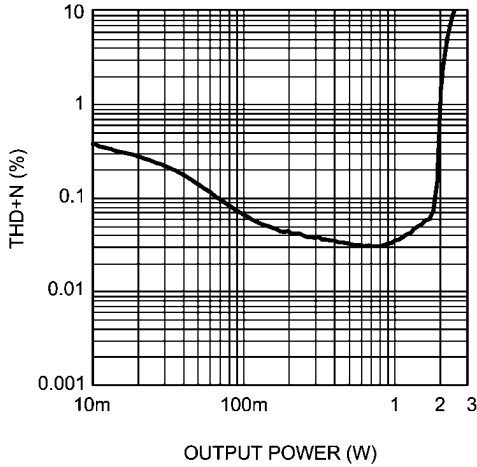

30009580

THD+N vs Output Power
 $V_{DD} = 5.0V, R_L = 4\Omega, A_V = 24dB$

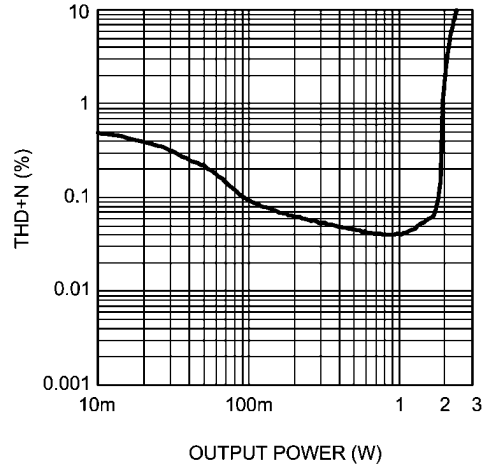

30009581

PSRR vs Frequency
 $V_{DD} = 3.6V, R_L = 8\Omega$

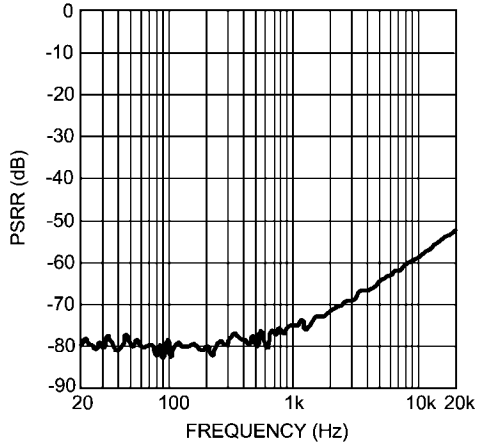

30009568

CMRR vs Frequency
 $V_{DD} = 3.6V, R_L = 8\Omega$

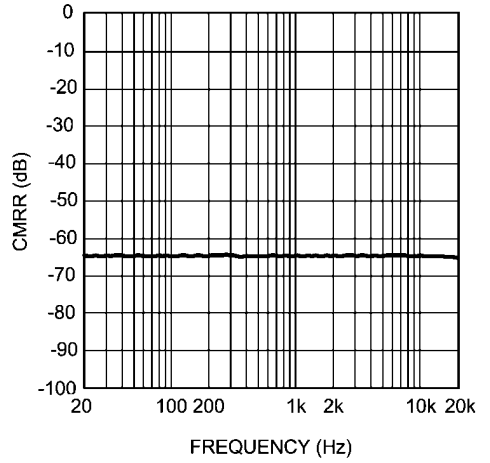

30009571

Quiescent Current vs Power Supply
 $R_L = \infty$

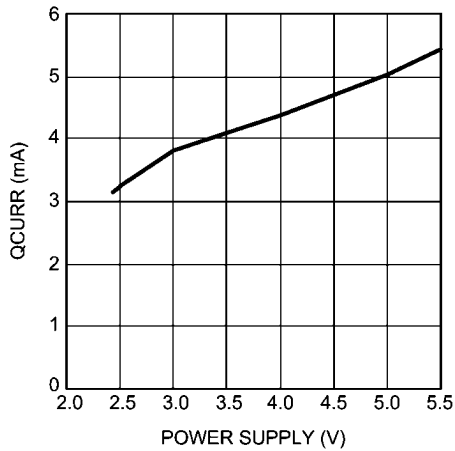

30009542

Output Power vs Supply Voltage
 $R_L = 4\Omega, f = 1kHz$

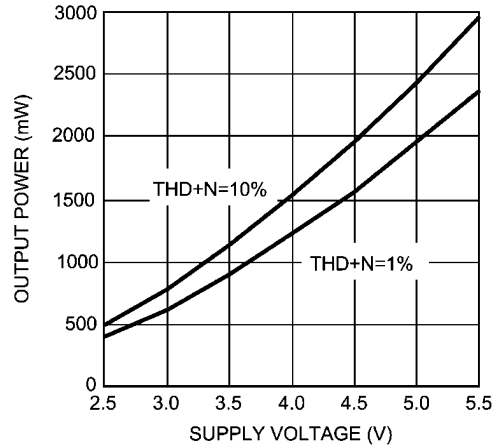

30009561

Output Power vs Supply Voltage
[查询"LM48411"供应商](#)
 $R_L = 8\Omega, f = 1kHz$

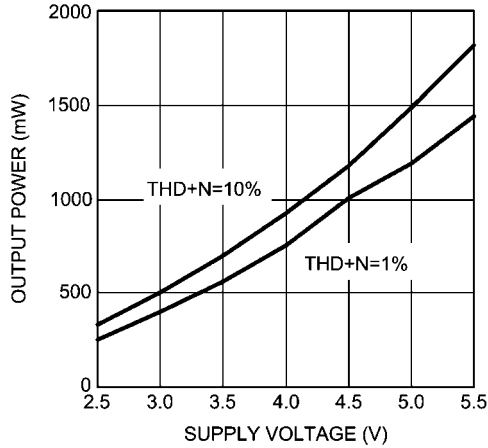

30009562

Efficiency vs Output Power
 $R_L = 4\Omega$

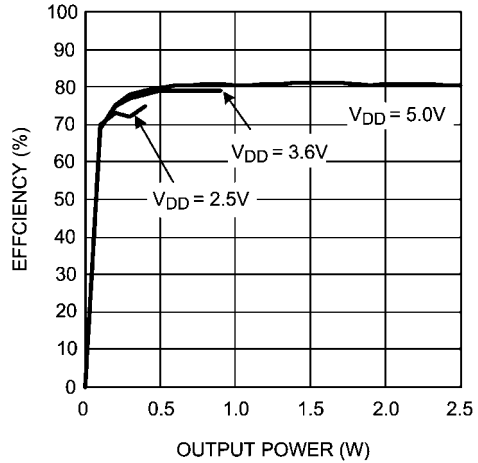

30009569

Efficiency vs Output Power
 $R_L = 8\Omega$

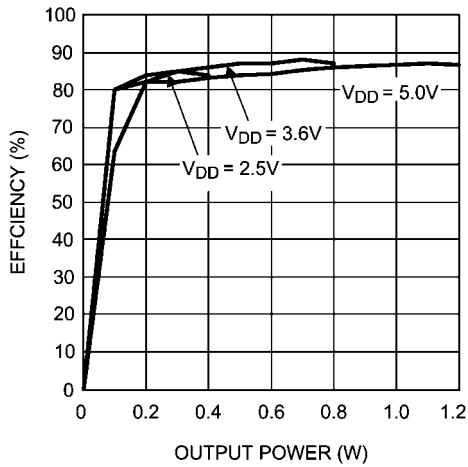

30009570

Crosstalk vs Frequency
 $V_{DD} = 3.6V, R_L = 8\Omega$

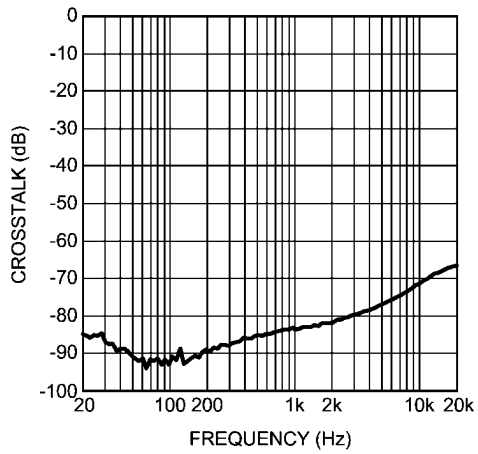

30009563

Power Dissipation vs Output Power
 $R_L = 4\Omega$

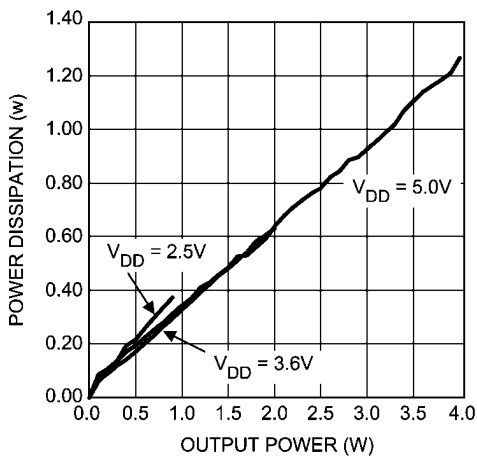

30009566

Power Dissipation vs Output Power
 $R_L = 8\Omega$

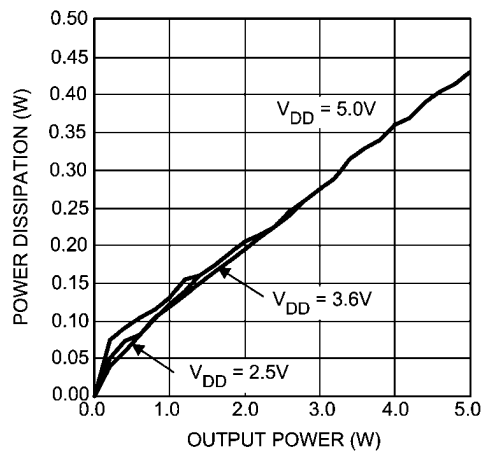

30009567

External Components Description

[查询"LM48411TL"供应商](#)
(Figure 1)

| Components | | Functional Description |
|------------|-------|---|
| 1. | C_S | Supply bypass capacitor which provides power supply filtering. Refer to the Power Supply Bypassing section for information concerning proper placement and selection of the supply bypass capacitor. |
| 2. | C_I | Input AC coupling capacitor which blocks the DC voltage at the amplifier's input terminals. |

Application Information

GENERAL AMPLIFIER FUNCTION

The LM48411 features a filterless modulation scheme. The differential outputs of the device switch at 300kHz from V_{DD} to GND. When there is no input signal applied, the two outputs (V_{O1} and V_{O2}) switch with a 50% duty cycle, with both outputs in phase. Because the outputs of the LM48411 are differential, the two signals cancel each other. This results in no net voltage across the speaker, thus there is no load current during an idle state, conserving power.

With an input signal applied, the duty cycle (pulse width) of the LM48411 outputs changes. For increasing output voltages, the duty cycle of V_{O1} increases, while the duty cycle of V_{O2} decreases. For decreasing output voltages, the converse occurs, the duty cycle of V_{O2} increases while the duty cycle of V_{O1} decreases. The difference between the two pulse widths yields the differential output voltage.

SPREAD SPECTRUM MODULATION

The LM48411 features a filterless spread spectrum modulation scheme that eliminates the need for output filters, ferrite beads or chokes. The switching frequency varies by $\pm 30\%$ about a 300kHz center frequency, reducing the wideband spectral content, improving EMI emissions radiated by the speaker and associated cables and traces. Where a fixed frequency class D exhibits large amounts of spectral energy at multiples of the switching frequency, the spread spectrum architecture of the LM48411 spreads that energy over a larger bandwidth. The cycle-to-cycle variation of the switching period does not affect the audio reproduction of efficiency.

ENHANCED EMISSIONS SUPPRESSION SYSTEM (E²S)

The LM48411 features National's patent-pending E²S system that reduces EMI, while maintaining high quality audio reproduction and efficiency. The E²S system features a synchronizable oscillator with selectable spread spectrum, and advanced edge rate control (ERC). The LM48411 ERC greatly reduces the high frequency components of the output square waves by controlling the output rise and fall times, slowing the transitions to reduce RF emissions, while maximizing THD+N and efficiency performance.

POWER DISSIPATION AND EFFICIENCY

In general terms, efficiency is considered to be the ratio of useful work output divided by the total energy required to produce it with the difference being the power dissipated, typically, in the IC. The key here is "useful" work. For audio systems, the energy delivered in the audible bands is considered useful including the distortion products of the input signal. Sub-sonic (DC) and super-sonic components (>22kHz) are not useful. The difference between the power flowing from the power supply and the audio band power being transduced is dissipated in the LM48411 and in the transducer load. The amount of power dissipation in the LM48411 is very low. This is because the ON resistance of the switches used to form the output waveforms is typically less than 0.25Ω . This leaves only the transducer load as a potential "sink" for the small excess of input power over audio band output power. The LM48411 dissipates only a fraction of the excess power requiring no additional PCB area or copper plane to act as a heat sink.

DIFFERENTIAL AMPLIFIER EXPLANATION

As logic supply voltages continue to shrink, designers are increasingly turning to differential analog signal handling to preserve signal to noise ratios with restricted voltage swing. The LM48411 is a fully differential amplifier that features differential input and output stages. A differential amplifier amplifies the difference between the two input signals. Traditional audio power amplifiers have typically offered only single-ended inputs resulting in a 6dB reduction in signal to noise ratio relative to differential inputs. The LM48411 also offers the possibility of DC input coupling which eliminates the two external AC coupling, DC blocking capacitors. The LM48411 can be used, however, as a single ended input amplifier while still retaining its fully differential benefits. In fact, completely unrelated signals may be placed on the input pins. The LM48411 simply amplifies the difference between the signals. A major benefit of a differential amplifier is the improved common mode rejection ratio (CMRR) over single input amplifiers. The common-mode rejection characteristic of the differential amplifier reduces sensitivity to ground offset related noise injection, especially important in high noise applications.

PCB LAYOUT CONSIDERATIONS

As output power increases, interconnect resistance (PCB traces and wires) between the amplifier, load and power supply create a voltage drop. The voltage loss on the traces between the LM48411 and the load results in lower output power and decreased efficiency. Higher trace resistance between the supply and the LM48411 has the same effect as a poorly regulated supply, increased ripple on the supply line also reducing the peak output power. The effects of residual trace resistance increases as output current increases due to higher output power, decreased load impedance or both. To maintain the highest output voltage swing and corresponding peak output power, the PCB traces that connect the output pins to the load and the supply pins to the power supply should be as wide as possible to minimize trace resistance.

The use of power and ground planes will give the best THD +N performance. While reducing trace resistance, the use of power planes also creates parasitic capacitors that help to filter the power supply line.

The inductive nature of the transducer load can also result in overshoot on one or both edges, clamped by the parasitic diodes to GND and V_{DD} in each case. From an EMI standpoint, this is an aggressive waveform that can radiate or conduct to other components in the system and cause interference. It is essential to keep the power and output traces short and well shielded if possible. Use of ground planes, beads, and micro-strip layout techniques are all useful in preventing unwanted interference.

As the distance from the LM48411 and the speaker increase, the amount of EMI radiation will increase since the output wires or traces acting as antenna become more efficient with length. What is acceptable EMI is highly application specific. Ferrite chip inductors placed close to the LM48411 may be needed to reduce EMI radiation. The value of the ferrite chip is very application specific.

POWER SUPPLY BYPASSING

As with any power amplifier, proper supply bypassing is critical for low noise performance and high power supply rejection ratio (PSRR). The capacitor (C_S) location should be as close as possible to the LM48411. Typical applications employ a voltage regulator with a $10\mu\text{F}$ and a $0.1\mu\text{F}$ bypass

capacitors that increase supply stability. These capacitors do not eliminate the need for bypassing on the supply pin of the LM48411. A 4.7µF tantalum capacitor is recommended.

SHUTDOWN FUNCTION

In order to reduce power consumption while not in use, the LM48411 contains shutdown circuitry that reduces current draw to less than 0.01µA. The trigger point for shutdown is shown as a typical value in the Electrical Characteristics Tables and in the Shutdown Hysteresis Voltage graphs found in the **Typical Performance Characteristics** section. It is best to switch between ground and supply for minimum current usage while in the shutdown state. While the LM48411 may be disabled with shutdown voltages in between ground and supply, the idle current will be greater than the typical 0.01µA value. Increased THD may also be observed with voltages less than V_{DD} on the Shutdown pin when in PLAY mode.

The LM48411 has an internal resistor connected between GND and Shutdown pins. The purpose of this resistor is to eliminate any unwanted state changes when the Shutdown pin is floating. The LM48411 will enter the shutdown state when the Shutdown pin is left floating or if not floating, when the shutdown voltage has crossed the threshold. To minimize the supply current while in the shutdown state, the Shutdown pin should be driven to GND or left floating. If the Shutdown pin is not driven to GND, the amount of additional resistor current due to the internal shutdown resistor can be found by Equation (1) below.

$$(V_{SD} - GND) / 300k\Omega \quad (1)$$

With only a 0.5V difference, an additional 1.7µA of current will be drawn while in the shutdown state.

PROPER SELECTION OF EXTERNAL COMPONENTS

The gain of the LM48411 is set by the external resistors, R_i in Figure 1, The Gain is given by Equation (2) below. Best THD+N performance is achieved with a gain of 2V/V (6dB).

$$A_V = 2 * 150 k\Omega / R_i \quad (V/V) \quad (2)$$

It is recommended that resistors with 1% tolerance or better be used to set the gain of the LM48411. The R_i resistors should be placed close to the input pins of the LM48411. Keeping the input traces close to each other and of the same length in a high noise environment will aid in noise rejection due to the good CMRR of the LM48411. Noise coupled onto input traces which are physically close to each other will be common mode and easily rejected by the LM48411.

Input capacitors may be needed for some applications or when the source is single-ended (see Figures 3, 5). Input capacitors are needed to block any DC voltage at the source so that the DC voltage seen between the input terminals of the LM48411 is 0V. Input capacitors create a high-pass filter with the input resistors, R_i . The -3dB point of the high-pass filter is found using Equation (3) below.

$$f_C = 1 / (2\pi R_i C_i) \quad (Hz) \quad (3)$$

The input capacitors may also be used to remove low audio frequencies. Small speakers cannot reproduce low bass frequencies so filtering may be desired. When the LM48411 is using a single-ended source, power supply noise on the ground is seen as an input signal by the +IN input pin that is capacitor coupled to ground (See Figures 5 – 7). Setting the high-pass filter point above the power supply noise frequencies, 217Hz in a GSM phone, for example, will filter out this noise so it is not amplified and heard on the output. Capacitors with a tolerance of 10% or better are recommended for impedance matching.

DIFFERENTIAL CIRCUIT CONFIGURATIONS

The LM48411 can be used in many different circuit configurations. The simplest and best performing is the DC coupled, differential input configuration shown in Figure 2. Equation (2) above is used to determine the value of the R_i resistors for a desired gain.

Input capacitors can be used in a differential configuration as shown in Figure 3. Equation (3) above is used to determine the value of the C_i capacitors for a desired frequency response due to the high-pass filter created by C_i and R_i . Equation (2) above is used to determine the value of the R_i resistors for a desired gain.

The LM48411 can be used to amplify more than one audio source. Figure 4 shows a dual differential input configuration. The gain for each input can be independently set for maximum design flexibility using the R_i resistors for each input and Equation (2). Input capacitors can be used with one or more sources as well to have different frequency responses depending on the source or if a DC voltage needs to be blocked from a source.

SINGLE-ENDED CIRCUIT CONFIGURATIONS

The LM48411 can also be used with single-ended sources but input capacitors will be needed to block any DC at the input terminals. Figure 5 shows the typical single-ended application configuration. The equations for Gain, Equation (2), and frequency response, Equation (3), hold for the single-ended configuration as shown in Figure 5.

When using more than one single-ended source as shown in Figure 6, the impedance seen from each input terminal should be equal. To find the correct values for C_{i3} and R_{i3} connected to the +IN input pin the equivalent impedance of all the single-ended sources are calculated. The single-ended sources are in parallel to each other. The equivalent capacitor and resistor, C_{i3} and R_{i3} , are found by calculating the parallel combination of all C_i values and then all R_i values. Equations (4) and (5) below are for any number of single-ended sources.

$$C_{i3} = C_{i1} + C_{i2} + C_{in} \dots \quad (F) \quad (4)$$

$$R_{i3} = 1 / (1/R_{i1} + 1/R_{i2} + 1/R_{in} \dots) \quad (\Omega) \quad (5)$$

The LM48411 may also use a combination of single-ended and differential sources. A typical application with one single-ended source and one differential source is shown in Figure 7. Using the principle of superposition, the external component values can be determined with the above equations corresponding to the configuration.

Revision History

[查询"LM48411TL"供应商](#)

| Rev | Date | Description |
|-----|----------|------------------|
| 1.0 | 09/21/07 | Initial release. |
| 1.1 | 10/01/07 | Fixed few typos. |

Physical Dimensions inches (millimeters) unless otherwise noted
[查询"LM48411TL"供应商](#)

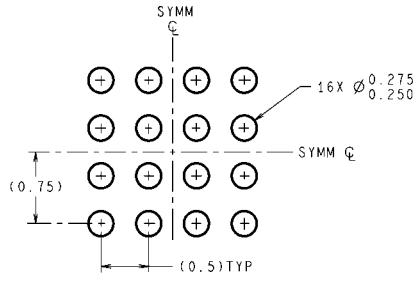

DIMENSIONS ARE IN MILLIMETERS
 DIMENSIONS IN () FOR REFERENCE ONLY

LAND PATTERN RECOMMENDATION

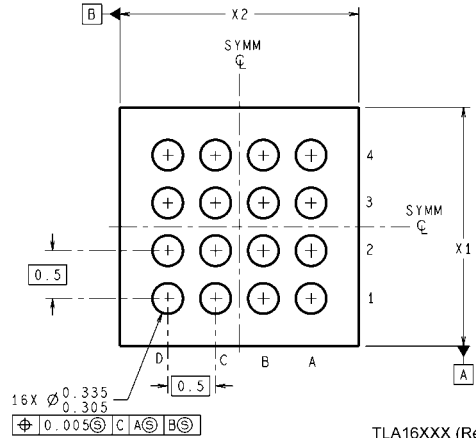
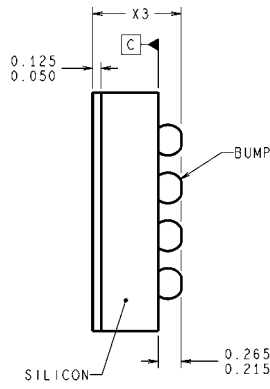
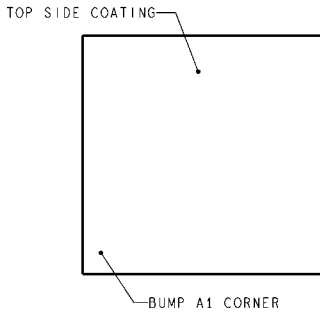

TLA16XXX (Rev C)

16 Bump micro SMD
Order Number LM48411TL
NS Package Number TLA16ACA
X1 = 1.996mm X2 = 2.047mm X3 = 0.6mm

Notes

[查询"LM48411TL"供应商](#)

[查询"LM48411TL"供应商](#)

Notes

THE CONTENTS OF THIS DOCUMENT ARE PROVIDED IN CONNECTION WITH NATIONAL SEMICONDUCTOR CORPORATION ("NATIONAL") PRODUCTS. NATIONAL MAKES NO REPRESENTATIONS OR WARRANTIES WITH RESPECT TO THE ACCURACY OR COMPLETENESS OF THE CONTENTS OF THIS PUBLICATION AND RESERVES THE RIGHT TO MAKE CHANGES TO SPECIFICATIONS AND PRODUCT DESCRIPTIONS AT ANY TIME WITHOUT NOTICE. NO LICENSE, WHETHER EXPRESS, IMPLIED, ARISING BY ESTOPPEL OR OTHERWISE, TO ANY INTELLECTUAL PROPERTY RIGHTS IS GRANTED BY THIS DOCUMENT.

TESTING AND OTHER QUALITY CONTROLS ARE USED TO THE EXTENT NATIONAL DEEMS NECESSARY TO SUPPORT NATIONAL'S PRODUCT WARRANTY. EXCEPT WHERE MANDATED BY GOVERNMENT REQUIREMENTS, TESTING OF ALL PARAMETERS OF EACH PRODUCT IS NOT NECESSARILY PERFORMED. NATIONAL ASSUMES NO LIABILITY FOR APPLICATIONS ASSISTANCE OR BUYER PRODUCT DESIGN. BUYERS ARE RESPONSIBLE FOR THEIR PRODUCTS AND APPLICATIONS USING NATIONAL COMPONENTS. PRIOR TO USING OR DISTRIBUTING ANY PRODUCTS THAT INCLUDE NATIONAL COMPONENTS, BUYERS SHOULD PROVIDE ADEQUATE DESIGN, TESTING AND OPERATING SAFEGUARDS.

EXCEPT AS PROVIDED IN NATIONAL'S TERMS AND CONDITIONS OF SALE FOR SUCH PRODUCTS, NATIONAL ASSUMES NO LIABILITY WHATSOEVER, AND NATIONAL DISCLAIMS ANY EXPRESS OR IMPLIED WARRANTY RELATING TO THE SALE AND/OR USE OF NATIONAL PRODUCTS INCLUDING LIABILITY OR WARRANTIES RELATING TO FITNESS FOR A PARTICULAR PURPOSE, MERCHANTABILITY, OR INFRINGEMENT OF ANY PATENT, COPYRIGHT OR OTHER INTELLECTUAL PROPERTY RIGHT.

LIFE SUPPORT POLICY

NATIONAL'S PRODUCTS ARE NOT AUTHORIZED FOR USE AS CRITICAL COMPONENTS IN LIFE SUPPORT DEVICES OR SYSTEMS WITHOUT THE EXPRESS PRIOR WRITTEN APPROVAL OF THE CHIEF EXECUTIVE OFFICER AND GENERAL COUNSEL OF NATIONAL SEMICONDUCTOR CORPORATION. As used herein:

Life support devices or systems are devices which (a) are intended for surgical implant into the body, or (b) support or sustain life and whose failure to perform when properly used in accordance with instructions for use provided in the labeling can be reasonably expected to result in a significant injury to the user. A critical component is any component in a life support device or system whose failure to perform can be reasonably expected to cause the failure of the life support device or system or to affect its safety or effectiveness.

National Semiconductor and the National Semiconductor logo are registered trademarks of National Semiconductor Corporation. All other brand or product names may be trademarks or registered trademarks of their respective holders.

Copyright© 2007 National Semiconductor Corporation

For the most current product information visit us at www.national.com



**National Semiconductor
Americas Customer
Support Center**
Email:
new.feedback@nsc.com
Tel: 1-800-272-9959

**National Semiconductor Europe
Customer Support Center**
Fax: +49 (0) 180-530-85-86
Email: europe.support@nsc.com
Deutsch Tel: +49 (0) 69 9508 6208
English Tel: +49 (0) 870 24 0 2171
Français Tel: +33 (0) 1 41 91 8790

**National Semiconductor Asia
Pacific Customer Support Center**
Email: ap.support@nsc.com

**National Semiconductor Japan
Customer Support Center**
Fax: 81-3-5639-7507
Email: jpn.feedback@nsc.com
Tel: 81-3-5639-7560