

Intelligent Power Module (R-Series)

Maximum Ratings and Characteristics

Outline Drawing

Absolute Maximum Ratings ($T_c=25^\circ\text{C}$)

Items	Symbols	Ratings		Units
		Min.	Max.	
DC Bus Voltage	V_{DC}	0	450	V
DC Bus Voltage (surge)	$V_{DC(Surge)}$	0	500	
DC Bus Voltage (short operating)	V_{SC}	200	400	
Collector-Emitter Voltage	V_{CES}	0	600	A
Inverter	Continuous I_C		300	
Collector	1ms I_{CP}		600	
Current	Duty=58.8% $-I_C$		300	
Collector Power Dissipation <small>One Transistor</small>	P_C		1040	W
Voltage of Power Supply for Driver	V_{CC}	0	20	V
Input Signal Voltage	V_{IN}	0	V_Z	
Input Signal Current	I_{IN}		1	mA
Alarm Signal Voltage	V_{ALM}	0	V_{CC}	V
Alarm Signal Current	I_{ALM}		15	mA
Junction Temperature	T_J		150	°C
Operating Temperature	T_{OP}	-20	100	
Storage Temperature	T_{stg}	-40	125	
Isolation Voltage	A.C. 1min. V_{iso}		2500	V
Screw Torque	Mounting *1		3.5	Nm
	Terminals *1		3.5	

Note: *1: Recommendable Value: 2.5 - 3.0 Nm (M5)

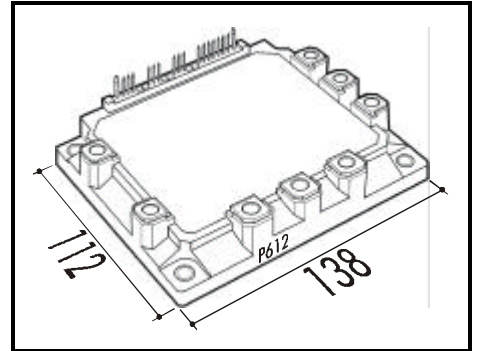

Electrical Characteristics of Power Circuit (at $T_J=25^\circ\text{C}$, $V_{CC}=15\text{V}$)

Items		Symbols	Conditions	Min.	Typ.	Max.	Units
INV	Collector Current At Off Signal Input	I_{CES}	$V_{CE}=600\text{V}$, Input Terminal Open			1.0	mA
	Collector-Emitter Saturation Voltage	$V_{CE(Sat)}$	$I_C=300\text{A}$			2.8	V
	Forward Voltage of FWD	V_F	$-I_C=300\text{A}$			3.0	V

Electrical Characteristics of Control Circuit (at $T_J=25^\circ\text{C}$, $V_{CC}=15\text{V}$)

Items	Symbols	Conditions	Min.	Typ.	Max.	Units
Current of P-Line Side Driver (One Unit)	I_{CCP}	$f_{sw}=0\sim 15\text{kHz}$, $T_c=-20\sim 100^\circ\text{C}$	6		32	mA
Current of N-Line Side Driver (Three Units)	I_{CCN}	$f_{sw}=0\sim 15\text{kHz}$, $T_c=-20\sim 100^\circ\text{C}$	24		114	
Input Signal Threshold Voltage	$V_{IN(th)}$	On	1.00	1.35	1.70	V
		Off	1.70	2.05	2.40	
Input Zener Voltage	V_Z	$R_{IN}=20\text{k}\Omega$		8.0		
Over Heating Protection Temperature Level	T_{COH}	$V_{DC}=0\text{V}$, $I_C=0\text{A}$, Case Temp.	110		125	°C
Hysteresis	T_{CH}			20		
IGBT Chips Over Heating Protec. Temp. Level	T_{OH}	Surface of IGBT Chip	150			
Hysteresis	T_{IH}			20		
Inverter Collector Current Protection Level	I_{OC}	$T_J=125^\circ\text{C}$	450			A
Over Current Detecting Time	t_{DOC}	$T_J=25^\circ\text{C}$		10		μs
Alarm Signal Hold Time	t_{ALM}		1.5	2		ms
Limiting Resistor for Alarm	R_{ALM}		1425	1500	1575	Ω
Under Voltage Protection Level	V_{UV}		11.0		12.5	V
Hysteresis	V_H		0.2			

Dynamic Characteristics (at $T_c=T_J=125^\circ\text{C}$, $V_{CC}=15\text{V}$)

Items	Symbols	Conditions	Min.	Typ.	Max.	Units
Switching Time	t_{ON}	$I_C=300\text{A}$, $V_{DC}=300\text{V}$	0.3			μs
	t_{OFF}				3.6	
	t_{RR}	$I_F=300\text{A}$, $V_{DC}=300\text{V}$			0.4	

Thermal Characteristics

Items	Symbols	Conditions	Min.	Typ.	Max.	Units
Thermal Resistance	$R_{th(j-c)}$	Inverter IGBT			0.12	°C/W
	$R_{th(j-c)}$	Diode			0.25	
	$R_{th(c-f)}$	With Thermal Compound		0.05		

■ Equivalent Circuit

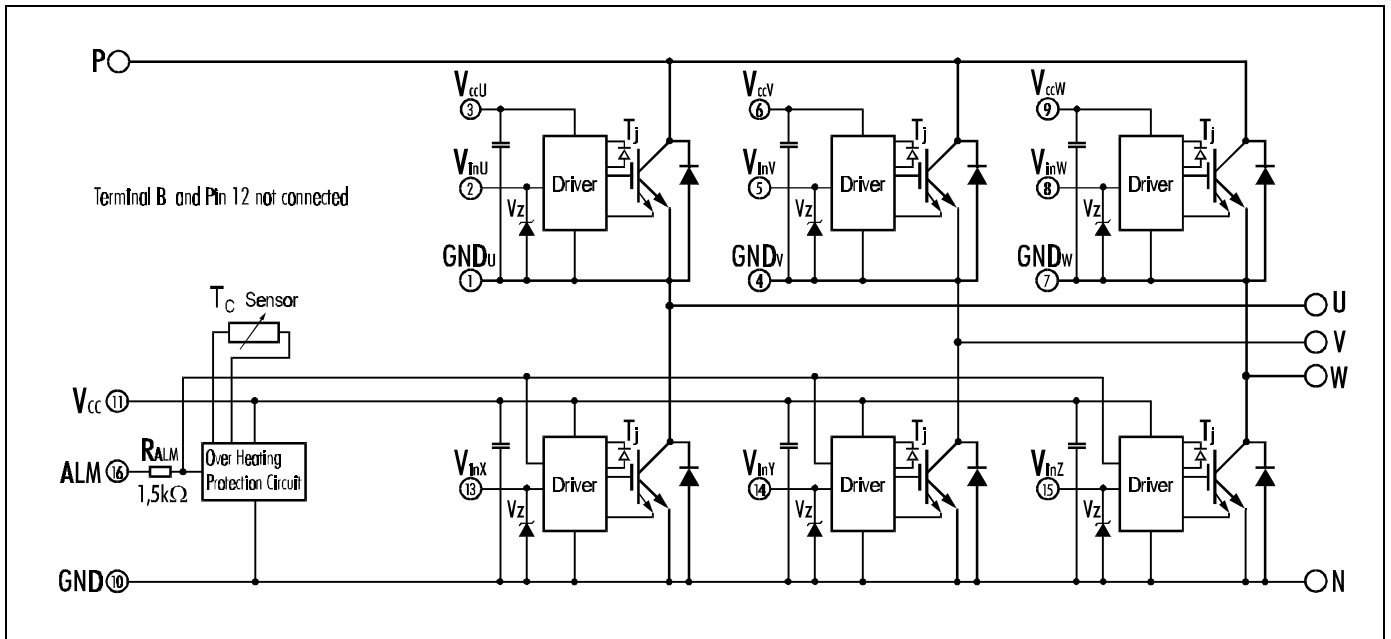

Drivers include following functions

- Short circuit protection circuit
- Amplifier for driver
- Undervoltage protection circuit
- Overcurrent protection circuit
- IGBT Chip overheating protection

Control Circuit

Power Supply Current vs. Switching Frequency

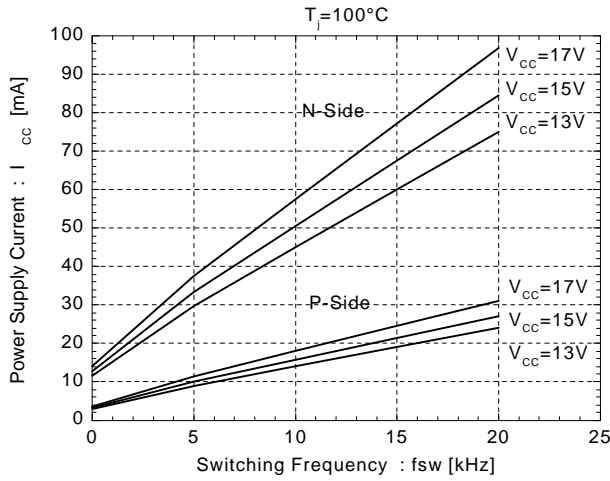

Input Signal Threshold Voltage vs. Power Supply Voltage

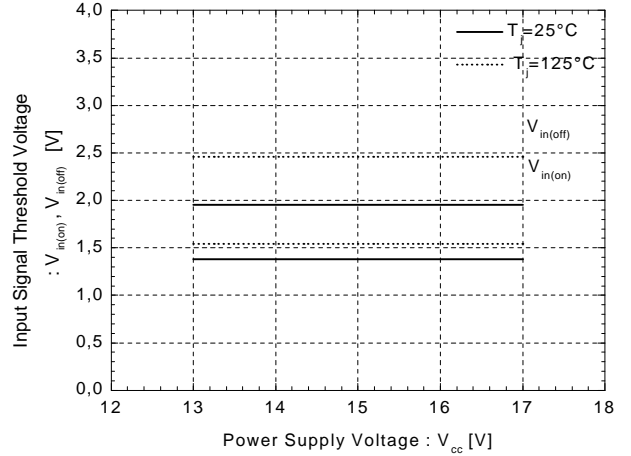

Under Voltage vs. Junction Temperature

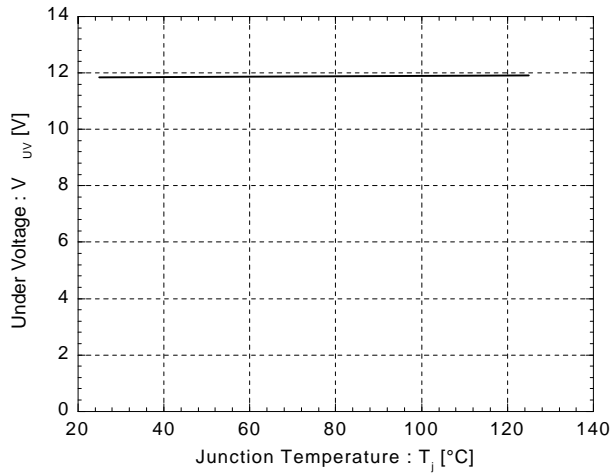

Under Voltage Hysteresis vs. Junction Temperature

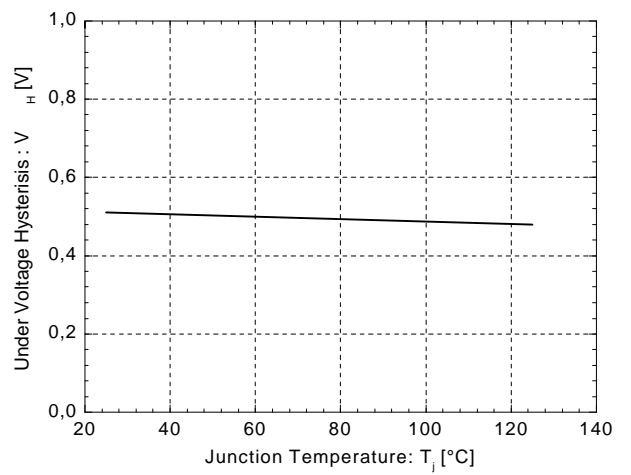

Alarm Hold Time vs. Power Supply Voltage

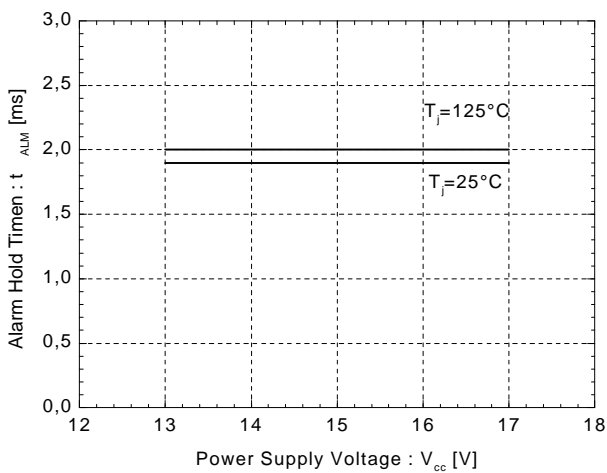

Over Heating Characteristics

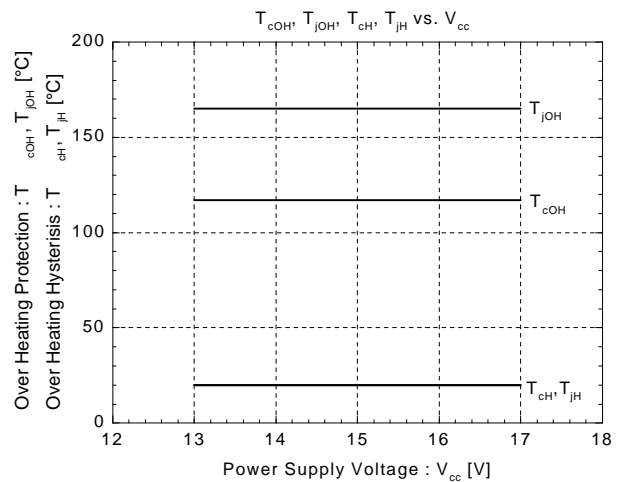

■ Inverter

Collector Current vs. Collector-Emitter Voltage

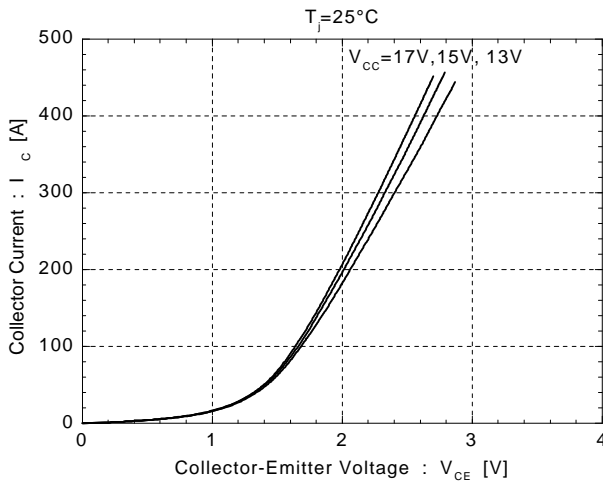

Collector Current vs. Collector-Emitter Voltage

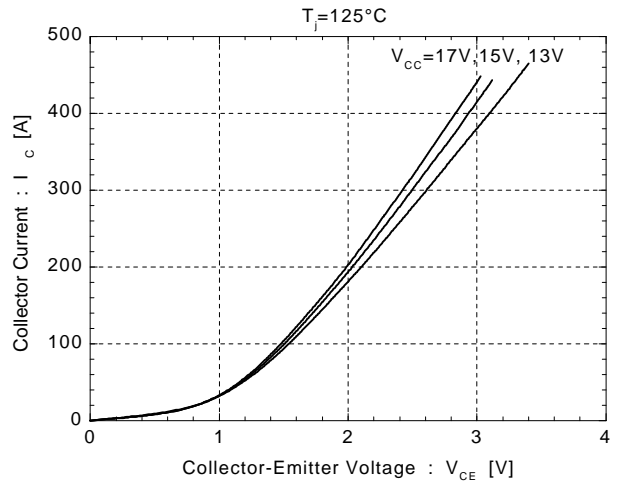

Switching Time vs. Collector Current

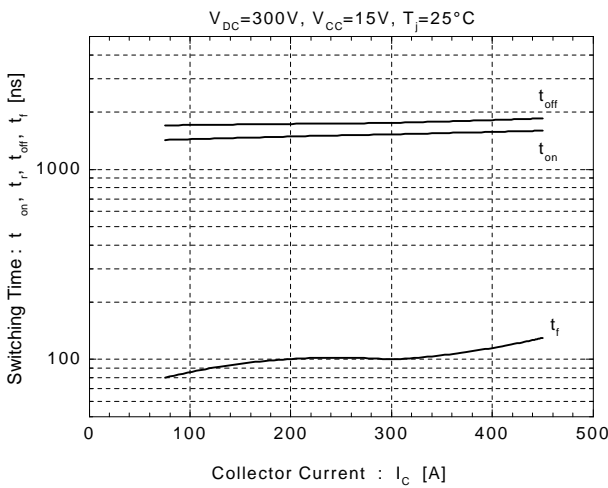

Switching Time vs. Collector Current

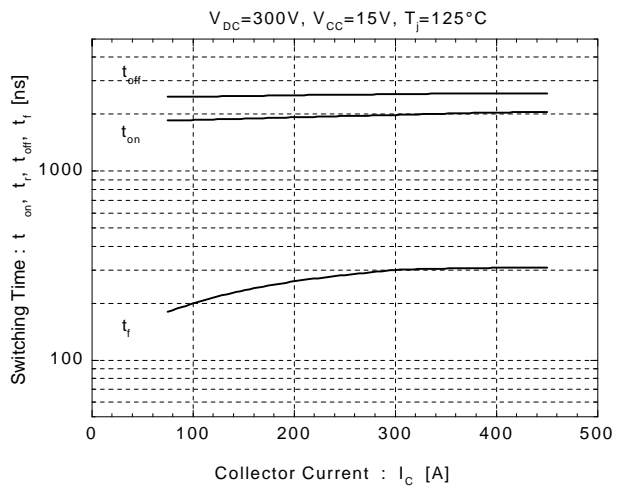

Forward Voltage vs. Forward Current

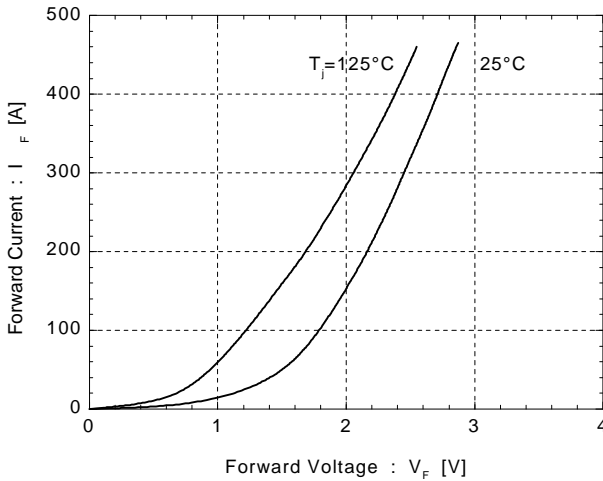

Reverse Recovery Characteristics

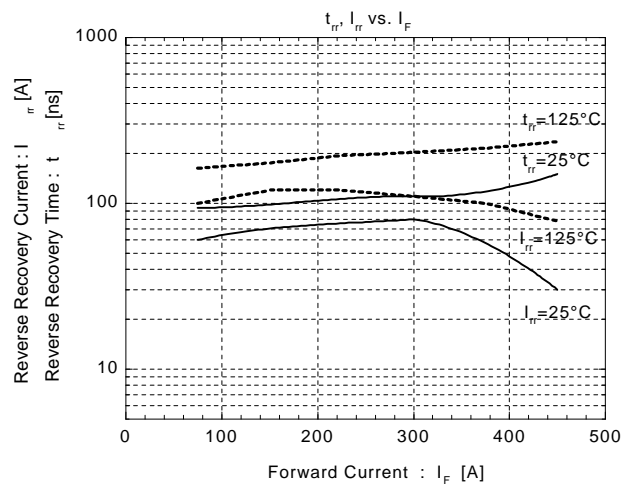

■ Inverter

Transient Thermal Resistance

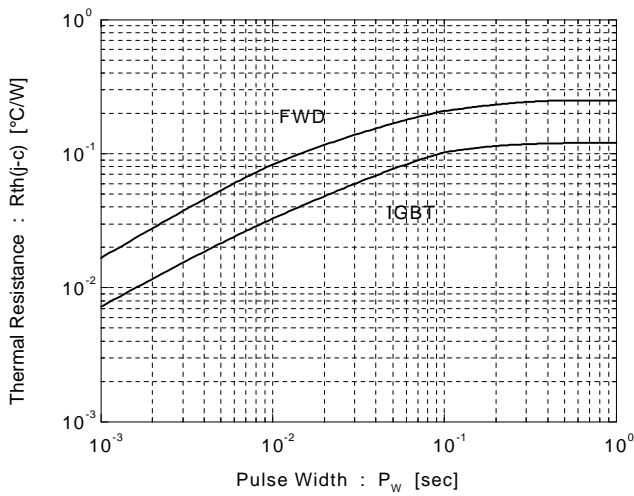

Reverse Biased Safe Operating Area

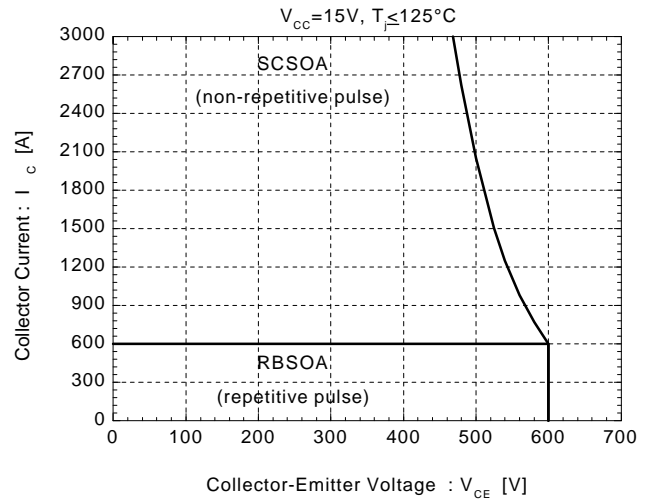

Power Derating For IGBT
(per device)

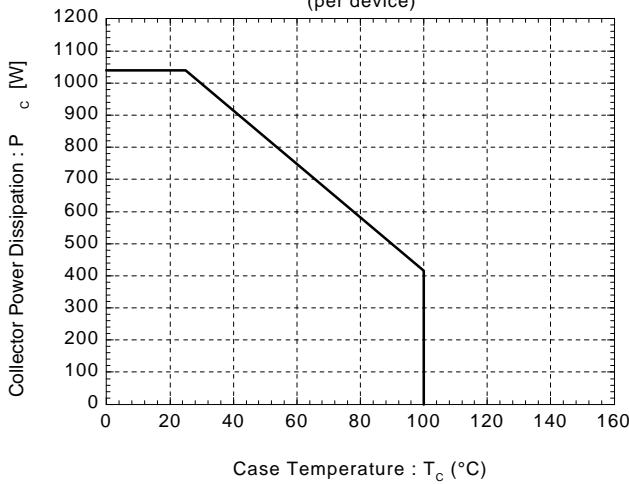

Switching Loss vs. Collector Current

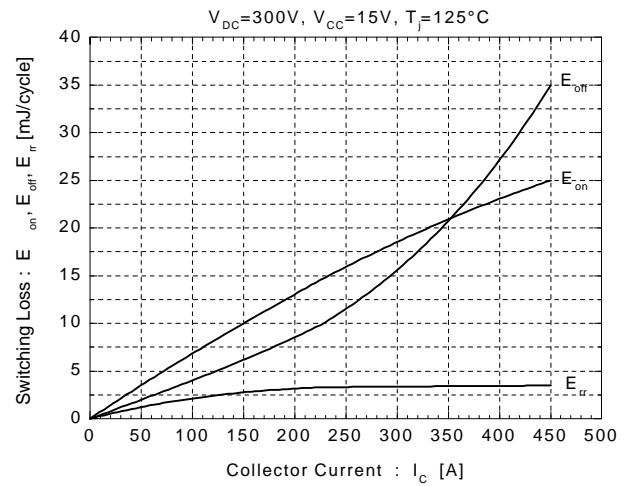

Switching Loss vs. Collector Current

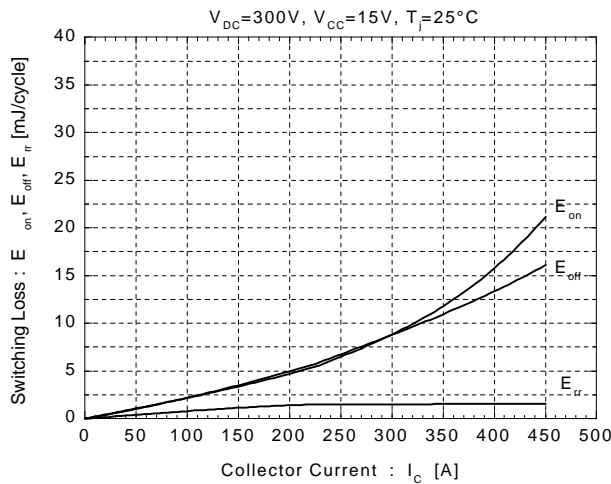

Switching Loss vs. Collector Current

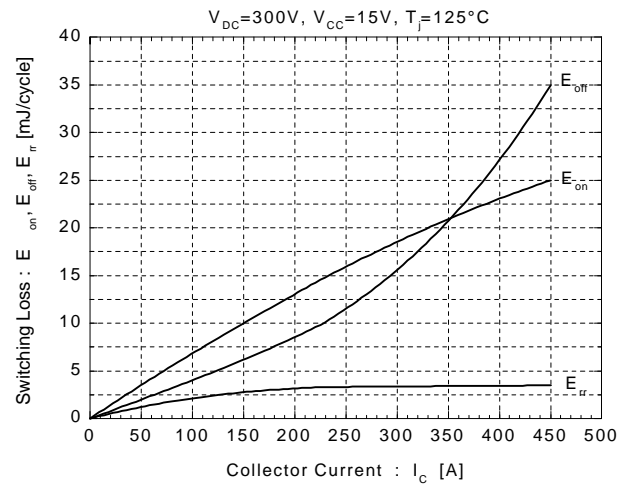

■ Inverter

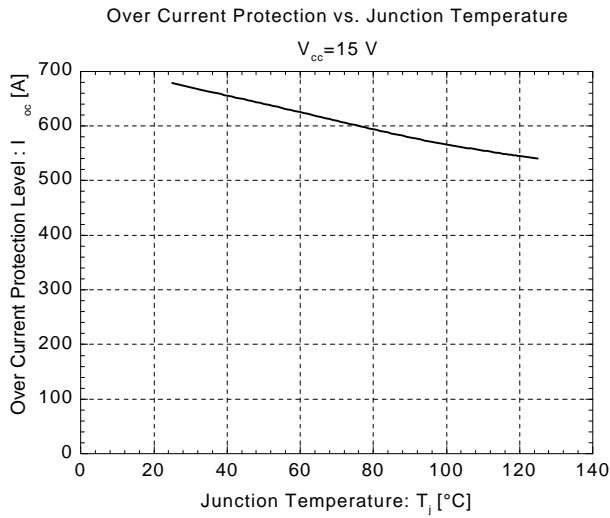

■ Outline Drawing

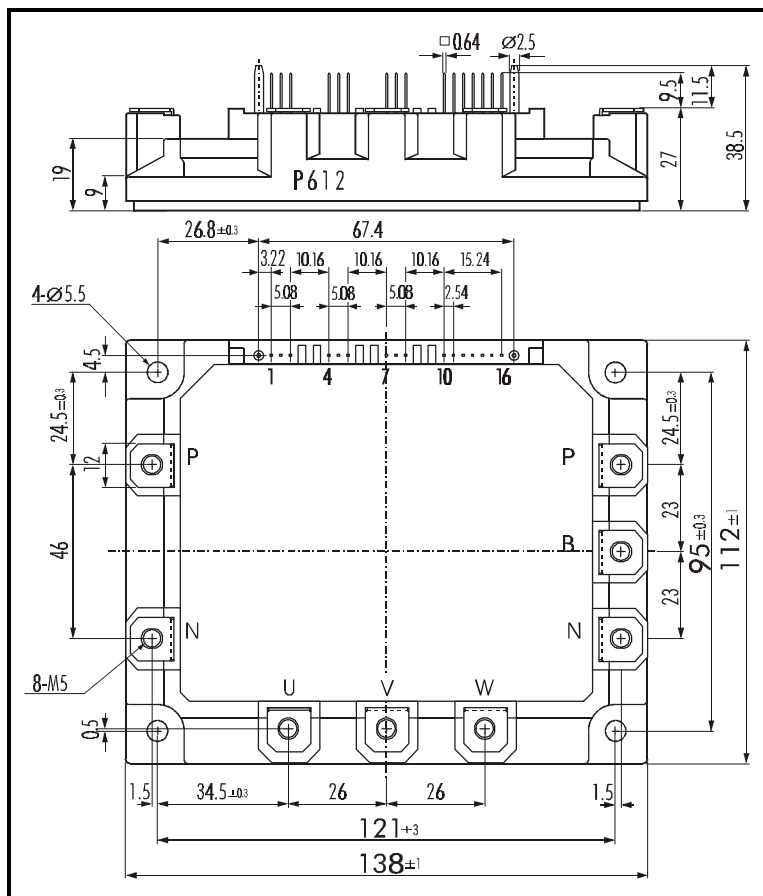

Weight: 920g