

2SK3656

VHF- and UHF-band Amplifier Applications

(Note)The TOSHIBA products listed in this document are intended for high frequency Power Amplifier of telecommunications equipment. These TOSHIBA products are neither intended nor warranted for any other use. Do not use these TOSHIBA products listed in this document except for high frequency Power Amplifier of telecommunications equipment.

- Output power: $P_O = 28.4\text{dBmW}$ (typ)
- Gain: $G_P = 15.4\text{dB}$ (typ)
- Drain efficiency: $\eta_D = 64\%$ (typ)

Absolute Maximum Ratings ($T_a = 25^\circ\text{C}$)

Characteristics	Symbol	Rating	Unit
Drain-source voltage	V_{DSS}	7.5	V
Gain-source voltage	V_{GSS} (Note 1)	3.5	V
Drain current	I_D	0.5	A
Power dissipation	P_D (Note 2)	3	W
Channel temperature	T_{ch}	150	$^\circ\text{C}$
Storage temperature range	T_{stg}	-45~150	$^\circ\text{C}$

Note: Using continuously under heavy loads (e.g. the application of high temperature/current/voltage and the significant change in temperature, etc.) may cause this product to decrease in the reliability significantly even if the operating conditions (i.e. operating temperature/current/voltage, etc.) are within the absolute maximum ratings. Please design the appropriate reliability upon reviewing the Toshiba Semiconductor Reliability Handbook ("Handling Precautions"/"Derating Concept and Methods") and individual reliability data (i.e. reliability test report and estimated failure rate, etc).

Note 1: Operating Ranges: 0~3.5V

Note 2: $T_c = 25^\circ\text{C}$ (When mounted on a 1.6 mm glass epoxy PCB)

Marking

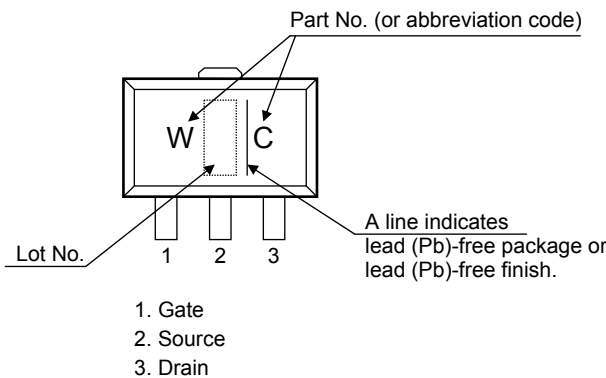

Unit: mm

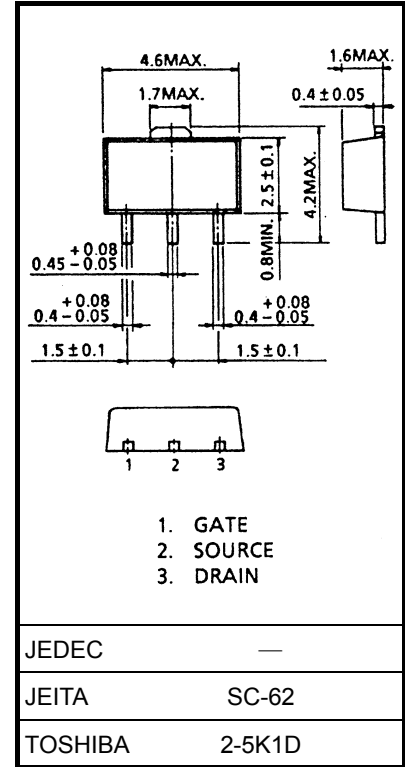

Weight: 0.05 g (typ.)

Caution: This device is sensitive to electrostatic discharge.

Please make enough tool and equipment earthed when you handle.

[查询"2SK3656"供应商](#)

Electrical Characteristics (Ta = 25°C)

Characteristics	Symbol	Test Condition	Min	Typ.	Max	Unit
Output power	P _O	V _{DS} = 3.6 V, I _{idle} = 50 mA (V _{GS} = adjust), f = 470 MHz, P _i = 13dBmW,	27.5	28.4	—	dBmW
Drain efficiency	η _D		50	64	—	%
Power gain	G _P		—	15.4	—	dB
Threshold voltage	V _{th}	V _{DS} = 3.6 V, I _D = 0.5 mA	0.2	—	1.2	V
Drain cut-off current	I _{DSS}	V _{DS} = 7.5 V, V _{GS} = 0 V	—	—	10	μA
Gate-source leakage current	I _{GSS}	V _{GS} = 3.5 V, V _{DS} = 0 V	—	—	5	μA
Load Mismatch (Note 3)	—	V _{DS} = 3.6 V, f = 470 MHz, P _i = 13dBmW, P _o = 27dBmW (V _{GS} = adjust), VSWR LOAD 10:1 all phase	No Degradation			—

Note 3: These characteristic values are measured using measurement tools specified by Toshiba.

Output Power Test Fixture

(Test Condition: f = 470 MHz, V_{DS} = 3.6 V, I_{idle} = 50 mA, P_i = 13 dBmW)

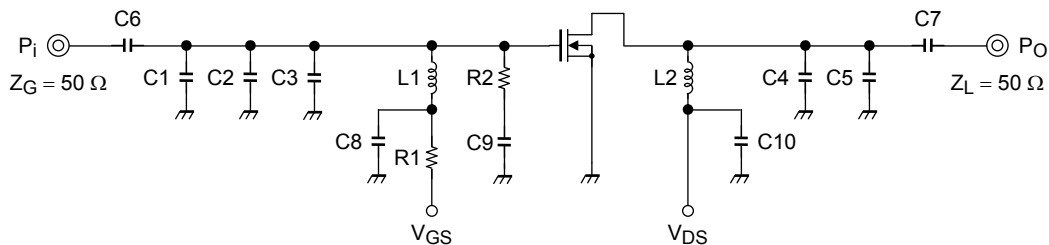

- | | | |
|---------------|------------------------------------|------------|
| C1: 7 pF | L1: φ0.6 mm enamel wire, 5.5ID, 5T | R1: 6.8 kΩ |
| C2: 10 pF | L2: φ0.6 mm enamel wire, 5.5ID, 7T | R2: 56 Ω |
| C3: 5 pF | | |
| C4: 13 pF | | |
| C5: 8 pF | | |
| C6: 2200 pF | | |
| C7: 2200 pF | | |
| C8: 10000 pF | | |
| C9: 2200 pF | | |
| C10: 10000 pF | | |

查询"2SK3656"供应商

Po, Gp, η_D -Pi

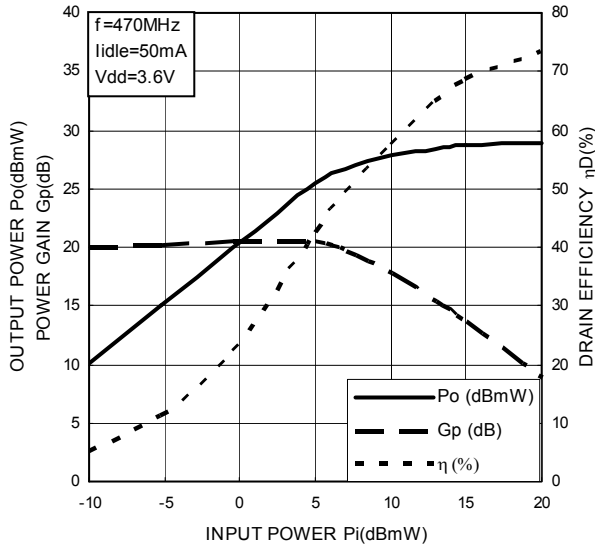

Gp, η_D -Iidle

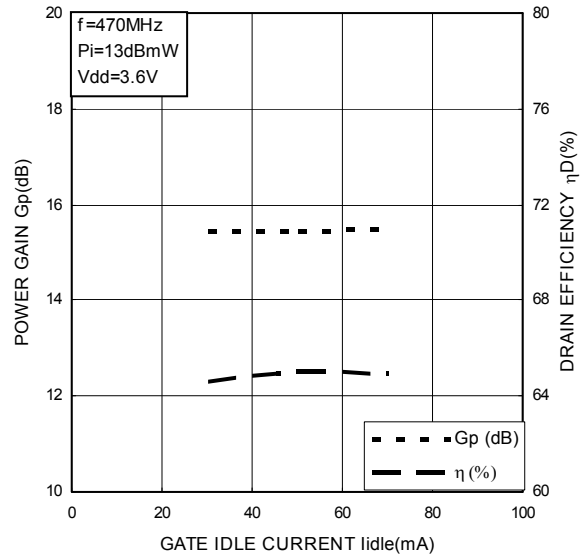

Po-Pi

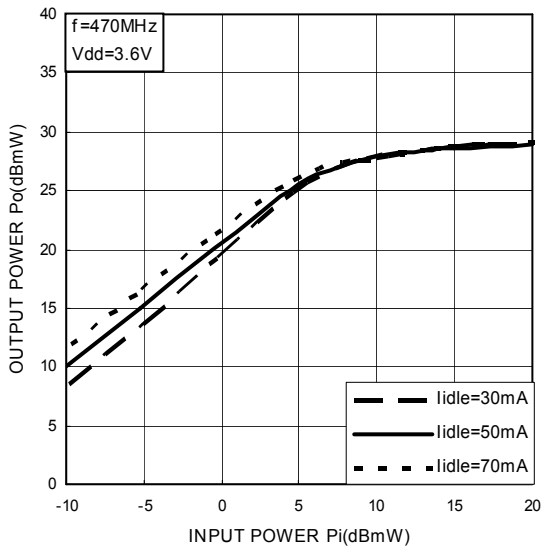

Pi-Idd

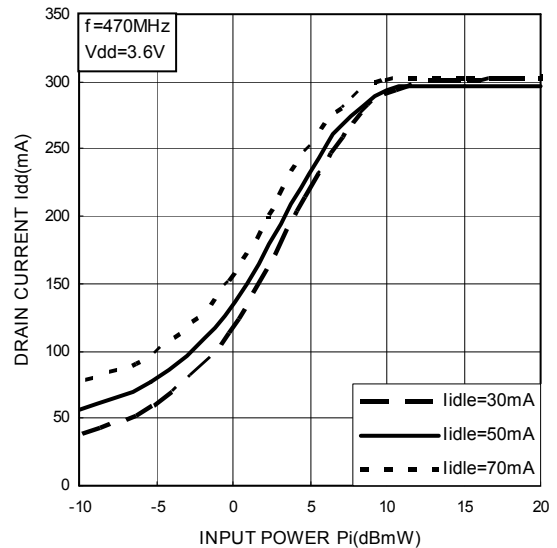

Gp, η_D -Vdd

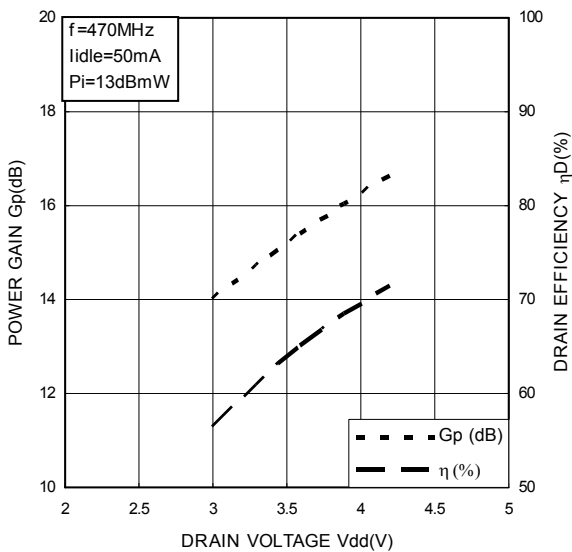

Po-Pi

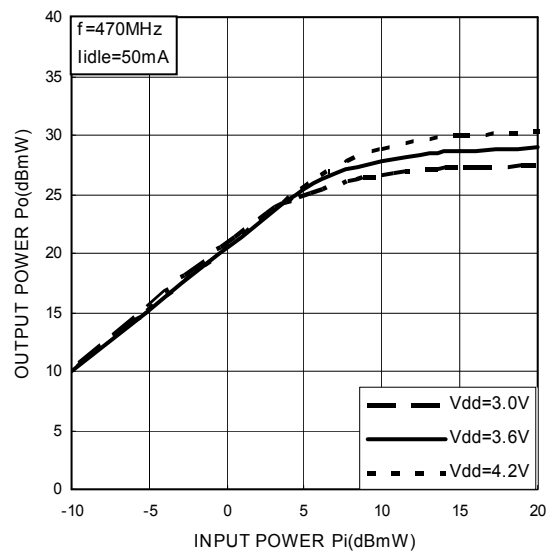

[查询"2SK3656"供应商](#)

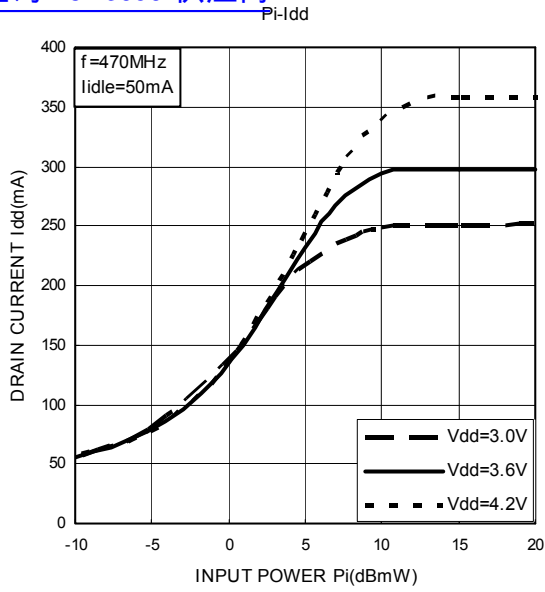

Note 4: These are only typical curves and devices are not necessarily guaranteed at these curves.

RESTRICTIONS ON PRODUCT USE

20070701-EN GENERAL

- The information contained herein is subject to change without notice.
- TOSHIBA is continually working to improve the quality and reliability of its products. Nevertheless, semiconductor devices in general can malfunction or fail due to their inherent electrical sensitivity and vulnerability to physical stress. It is the responsibility of the buyer, when utilizing TOSHIBA products, to comply with the standards of safety in making a safe design for the entire system, and to avoid situations in which a malfunction or failure of such TOSHIBA products could cause loss of human life, bodily injury or damage to property.
In developing your designs, please ensure that TOSHIBA products are used within specified operating ranges as set forth in the most recent TOSHIBA products specifications. Also, please keep in mind the precautions and conditions set forth in the "Handling Guide for Semiconductor Devices," or "TOSHIBA Semiconductor Reliability Handbook" etc.
- The TOSHIBA products listed in this document are intended for usage in general electronics applications (computer, personal equipment, office equipment, measuring equipment, industrial robotics, domestic appliances, etc.). These TOSHIBA products are neither intended nor warranted for usage in equipment that requires extraordinarily high quality and/or reliability or a malfunction or failure of which may cause loss of human life or bodily injury ("Unintended Usage"). Unintended Usage include atomic energy control instruments, airplane or spaceship instruments, transportation instruments, traffic signal instruments, combustion control instruments, medical instruments, all types of safety devices, etc.. Unintended Usage of TOSHIBA products listed in this document shall be made at the customer's own risk.
- The products described in this document shall not be used or embedded to any downstream products of which manufacture, use and/or sale are prohibited under any applicable laws and regulations.
- The information contained herein is presented only as a guide for the applications of our products. No responsibility is assumed by TOSHIBA for any infringements of patents or other rights of the third parties which may result from its use. No license is granted by implication or otherwise under any patents or other rights of TOSHIBA or the third parties.
- Please contact your sales representative for product-by-product details in this document regarding RoHS compatibility. Please use these products in this document in compliance with all applicable laws and regulations that regulate the inclusion or use of controlled substances. Toshiba assumes no liability for damage or losses occurring as a result of noncompliance with applicable laws and regulations.