



.100" Standard Length Jumpers offer you easy ordering and fast delivery.

Two types of standard ribbon cable jumpers are now readily available to serve your needs.

Molex introduces a complete line of .100" ribbon cable jumpers for terminating cable directly into PCBs. Two types of jumpers are now available: Strip & retain jumpers and new kinked tail jumpers featuring increased board retention.

Molex ribbon cable jumpers are available in a wide variety of lengths and circuit sizes. These standard length jumpers are easy to order and feature shorter lead times. All Molex jumpers are made from our high quality topcoat ribbon cable, manufactured in our QS 9000 certified facility.

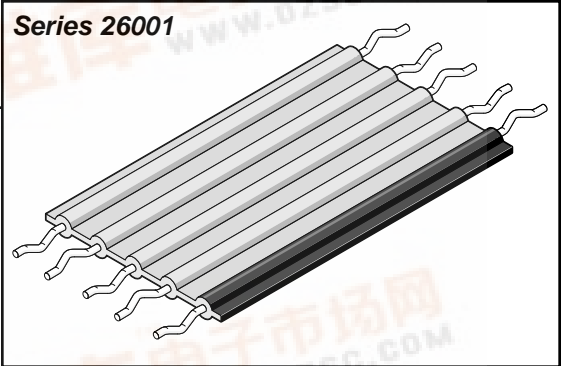
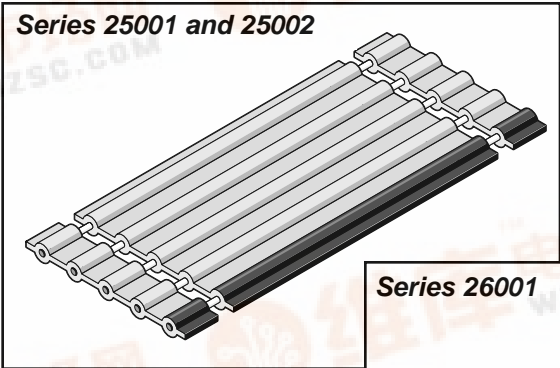

Features

- Standard lengths - easy to order with standard pricing
- Variety of lengths and circuit sizes available for every application
- PVC jacketed cable - most economical cable type
- UL style 2651 cable, CSA certified, complete agency approval

Series 25001 Strip and Retain Jumpers - 26 AWG

Series 25002 Strip and Retain Jumpers - 24 AWG

- Strip and retain protects wire tips from bending prior to board insertion
- Stranded topcoat wire - conductors made of twisted wire strands for increased flexibility. Tin coating prevents exposed wire tips from fraying after stripping insulation
- .125" (3.18mm) strip length for standard .062" (1.58mm) thick PC board

Series 26001 Kinked Tail Jumpers - 24 AWG

- Kinked tails improve retention of jumper to board prior to soldering. Same PCB hole layout as straight jumpers (without kinked tails)
- Solid tinned wire used to provide rigid kinked tails for easy insertion
- .128" (3.25mm) strip length - after kinking tails for standard .062" (1.58mm) thick PC board

Technical Specifications

Recommended Hole Diameter:

AWG	Diameter	Tolerance
26	.032" (.80mm)	±.003" (.08mm)
24	.037" (.95mm)	±.004" (.10mm)

Agency Approvals and Ratings:

- UL style 2651 gray PVC cable, File #61522
- CSA Certification, File #LL61126
- UL voltage rating 300 V max.

- UL temperature rating -20° to 105°C
- UL flammability rating VW-1



.100" Kinked Tail and Strip & Retain Jumpers

查询"25002"供应商

Ordering Information and Dimensions

in
mm

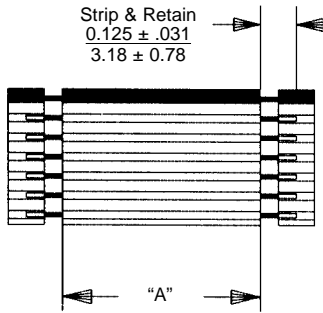

25001

Ordering Information: Series 25001 .100" Strip and Retain Jumpers - 26 AWG

Circuits	Insulation Length "A"							
	1.000"	2.000"	3.000"	4.000"	5.000"	6.000"	7.000"	8.000"
3	25001-0301	25001-0302	25001-0303	25001-0304	25001-0305	25001-0306	25001-0307	25001-0308
4	25001-0401	25001-0402	25001-0403	25001-0404	25001-0405	25001-0406	25001-0407	25001-0408
5	25001-0501	25001-0502	25001-0503	25001-0504	25001-0505	25001-0506	25001-0507	25001-0508
6	25001-0601	25001-0602	25001-0603	25001-0604	25001-0605	25001-0606	25001-0607	25001-0608
7	25001-0701	25001-0702	25001-0703	25001-0704	25001-0705	25001-0706	25001-0707	25001-0708
8	25001-0801	25001-0802	25001-0803	25001-0804	25001-0805	25001-0806	25001-0807	25001-0808
9	25001-0901	25001-0902	25001-0903	25001-0904	25001-0905	25001-0906	25001-0907	25001-0908
10	25001-1001	25001-1002	25001-1003	25001-1004	25001-1005	25001-1006	25001-1007	25001-1008

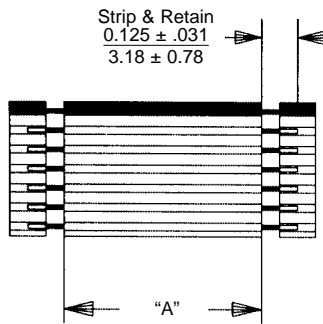

25002

Ordering Information: Series 25002 .100" Strip and Retain Jumpers - 24 AWG

Circuits	Insulation Length "A"							
	1.000"	2.000"	3.000"	4.000"	5.000"	6.000"	7.000"	8.000"
3	25002-0301	25002-0302	25002-0303	25002-0304	25002-0305	25002-0306	25002-0307	25002-0308
4	25002-0401	25002-0402	25002-0403	25002-0404	25002-0405	25002-0406	25002-0407	25002-0408
5	25002-0501	25002-0502	25002-0503	25002-0504	25002-0505	25002-0506	25002-0507	25002-0508
6	25002-0601	25002-0602	25002-0603	25002-0604	25002-0605	25002-0606	25002-0607	25002-0608
7	25002-0701	25002-0702	25002-0703	25002-0704	25002-0705	25002-0706	25002-0707	25002-0708
8	25002-0801	25002-0802	25002-0803	25002-0804	25002-0805	25002-0806	25002-0807	25002-0808
9	25002-0901	25002-0902	25002-0903	25002-0904	25002-0905	25002-0906	25002-0907	25002-0908
10	25002-1001	25002-1002	25002-1003	25002-1004	25002-1005	25002-1006	25002-1007	25002-1008

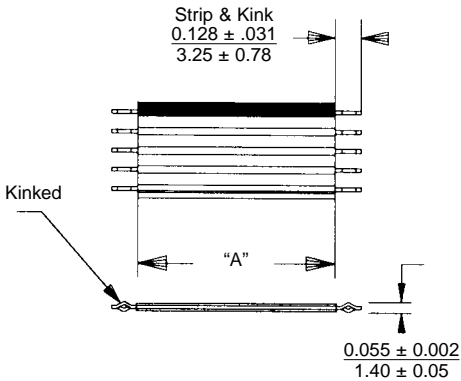

26001

Ordering Information: Series 26001 .100" Kinked Tail Jumpers - 24 AWG

Circuits	Insulation Length "A"							
	1.000"	2.000"	3.000"	4.000"	5.000"	6.000"	7.000"	8.000"
3	26001-0301	26001-0302	26001-0303	26001-0304	26001-0305	26001-0306	26001-0307	26001-0308
4	26001-0401	26001-0402	26001-0403	26001-0404	26001-0405	26001-0406	26001-0407	26001-0408
5	26001-0501	26001-0502	26001-0503	26001-0504	26001-0505	26001-0506	26001-0507	26001-0508
6	26001-0601	26001-0602	26001-0603	26001-0604	26001-0605	26001-0606	26001-0607	26001-0608
7	26001-0701	26001-0702	26001-0703	26001-0704	26001-0705	26001-0706	26001-0707	26001-0708
8	26001-0801	26001-0802	26001-0803	26001-0804	26001-0805	26001-0806	26001-0807	26001-0808
9	26001-0901	26001-0902	26001-0903	26001-0904	26001-0905	26001-0906	26001-0907	26001-0908
10	26001-1001	26001-1002	26001-1003	26001-1004	26001-1005	26001-1006	26001-1007	26001-1008



Bringing People & Technology Together, WorldwideSM

Worldwide Web Site: <http://www.molex.com>

Corporate Headquarters: 2222 Wellington Ct., Lisle, IL 60532 U.S.A., Tel: 630-969-4550 • European Headquarters: Munich, Germany, Tel: 49-89-413092-0

Far East North Headquarters: Kanagawa, Japan, Tel: 81-462-65-2324 • Far East South Headquarters: Jurong, Singapore, Tel: 65-268-6868