

FEATURES

- Low Operating Voltage: $\pm 5V$ to $\pm 15V$
- 500 μA Supply Current
- Zero Supply Current when Shut Down
- Outputs Can Be Driven $\pm 30V$
- Thermal Limiting
- Output "Open" when Off (Three-State)
- 10mA Output Drive
- Pinout Similar to 1488

APPLICATIONS

- RS232
- Power Supply Inverter
- Micropower Interface
- Level Translator

DESCRIPTION

The LT[®]1032 is a RS232 and RS423 line driver that operates over a $\pm 5V$ to $\pm 15V$ range on low supply current and can be shut down to zero supply current. Outputs are fully protected from externally applied voltages of $\pm 30V$ by both current and thermal limiting. Since the output swings to within 200mV of the positive supply and 600mV of the negative supply, power supply needs are minimized.

Also included is a strobe pin to force all outputs low independent of input or shutdown conditions. Further, slew rate can be adjusted with a resistor connected to the supply.

A major advantage of the LT1032 is the high impedance output state when off or powered down.

For applications requiring dual or triple RS232 driver/receiver devices, see the LT1180A (dual), LT1039A (triple) or the LT1130A data sheets.

 LTC and LT are registered trademarks of Linear Technology Corporation.

TYPICAL APPLICATION

RS232 Line Driver

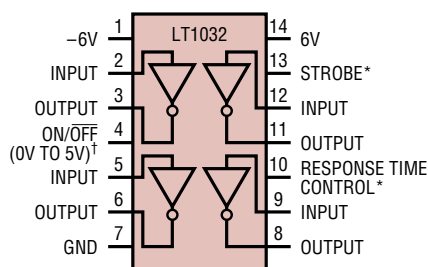

*NO CONNECTION NEEDED WHEN NOT USED
 †5V = ON

LT1032 • TA01

Output Swing vs Output Current

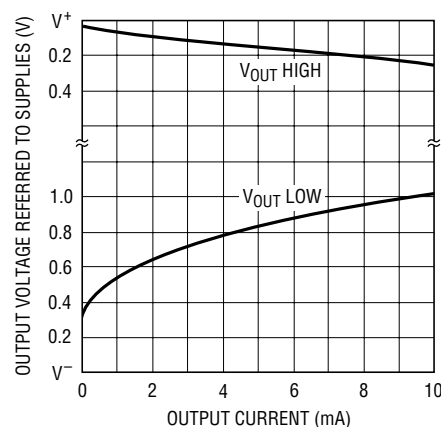

LT1032 • TA02

ABSOLUTE MAXIMUM RATINGS (Note 1)

Supply Voltage	±15V	Operating Temperature Range	
Logic Input Pins	V ⁻ to 25V	LT1032C	0°C to 70°C
ON/OFF Pin	GND to 15V	LT1032I	-40°C to 85°C
Output (Forced)	V ⁻ + 30V, V ⁺ - 30V	LT1032M	-55°C to 125°C
Response Pin	±6V	C Grade Guaranteed	
Short-Circuit Duration (to ±30V)	Indefinite	Functional by Design	-25°C to 85°C
Storage Temperature Range	-65°C to 150°C	Lead Temperature (Soldering, 10 sec)	300°C

PACKAGE/ORDER INFORMATION

<p>J PACKAGE 14-LEAD CERDIP</p> <p>N PACKAGE 14-LEAD PDIP</p> <p>T_{JMAX} = 85°C, θ_{JA} = 100°C/W, θ_{JC} = 60°C (CJ) T_{JMAX} = 85°C, θ_{JA} = 100°C/W, θ_{JC} = 60°C (CN) T_{JMAX} = 150°C, θ_{JA} = 100°C/W, θ_{JC} = 60°C (MJ)</p>	<p>ORDER PART NUMBER</p> <p>LT1032CJ LT1032CN LT1032IN LT1032MJ</p>	<p>SW PACKAGE 16-LEAD PLASTIC SO (WIDE)</p> <p>T_{JMAX} = 85°C, θ_{JA} = 80°C/W</p>	<p>ORDER PART NUMBER</p> <p>LT1032CSW LT1032ISW</p>
---	--	---	--

ELECTRICAL CHARACTERISTICS

The ● denotes specifications which apply over the full operating temperature range, otherwise specifications are at T_A = 25°C. Supply voltage = ±5V to ±15V

PARAMETER	CONDITIONS	MIN	TYP	MAX	UNITS
Supply Current	V _{ON/OFF} ≥ 2.4V, I _{OUT} = 0, All Outputs Low ●		500	1000	μA
Power Supply Leakage Current	V _{ON/OFF} ≤ 0.4V ●		1	10	μA
	V _{ON/OFF} ≤ 0.1V, T _A = 125°C ●		10	50	μA
Output Voltage Swing	Load = 2mA Positive Negative	V ⁺ - 0.3V	V ⁺ - 0.1V V ⁻ + 0.7V	V ⁻ + 0.9V	V
Output Current (Active)	V _{SUPPLY} = ±5V to ±15V	10	22		mA
Output Current (Shutdown)	V _{SUPPLY} = 0V, V _{OUT} = ±30V		2	100	μA
	V _{SUPPLY} = ±15V, V _{OUT} = ±20V		2	100	μA
Output Overload Voltage (Forced)	Operating or Shutdown ●	V ⁺ - 30V		V ⁻ + 30V	V
Input Overload Voltage (Forced)	Operating or Shutdown ●	V ⁻		30V	V
Logic Input Levels	Low Input (V _{OUT} = High) ●		1.4	0.8	V
	High Input (V _{OUT} = Low) ●	2	1.4		V
Logic Input Current	V _{IN} > 2.0V		2	20	μA
	V _{IN} < 0.8V		10	20	μA
ON/OFF Pin Current	0 ≤ V _{IN} ≤ 5V ●	-10	3	50	μA
Slew Rate	I _{RESPONSE} = 0, R _L = 3k	4	15	30	V/μs
Change in Slew Rate (Note 3)	I _{RESPONSE} = 50μA		50		%
	I _{RESPONSE} = -50μA		-50		%
Response Pin Leakage	V _{SUPPLY} = ±6V, V _{ON/OFF} ≤ 0.4V V _{RESPONSE} = ±6V		1		μA

Note 1: Absolute Maximum Ratings are those values beyond which the life of a device may be impaired.

Note 2: 3V applied to the strobe pin will force all outputs low. Strobe pin input impedance is about 2k to ground. Leave open when not used.

Note 3: Response can be changed by connecting a resistor to the supply. For supplies less than ±6V this current is disconnected when shut down. Leave open when not used.

TYPICAL PERFORMANCE CHARACTERISTICS

On Supply Current vs Temperature

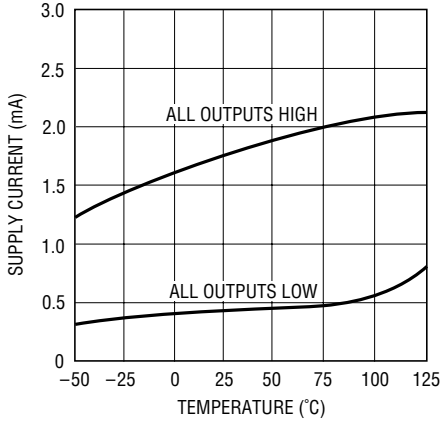

LT1032 • TPC01

Supply Current vs Supply Voltage

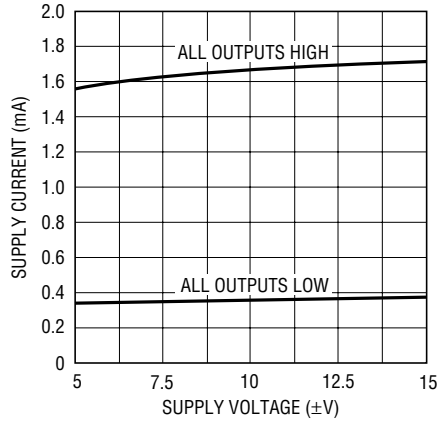

LT1032 • TPC02

Off Supply Current vs Temperature

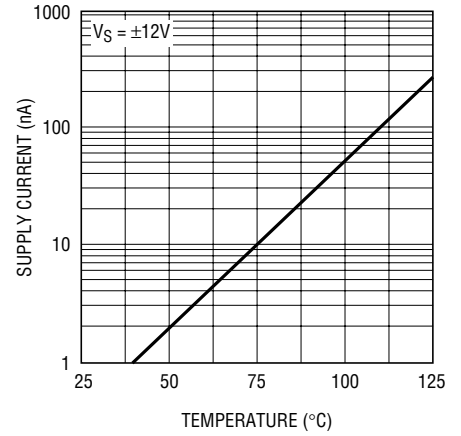

LT1032 • TPC03

Output Swing vs Output Current

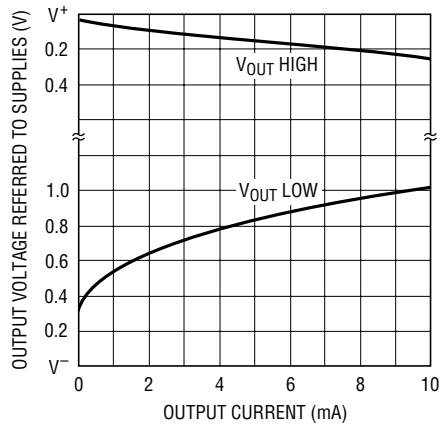

LT1032 • TA02

Output Leakage vs Temperature

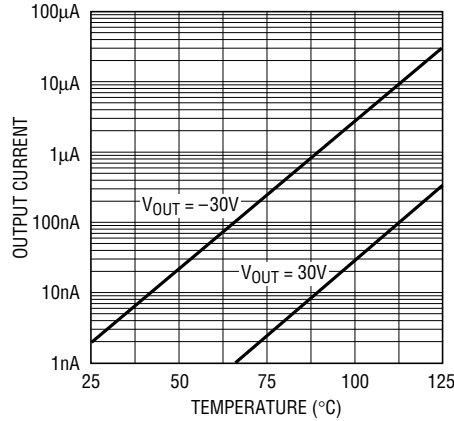

LT1032 • TPC05

Response Pin Leakage vs Temperature (Device Off)

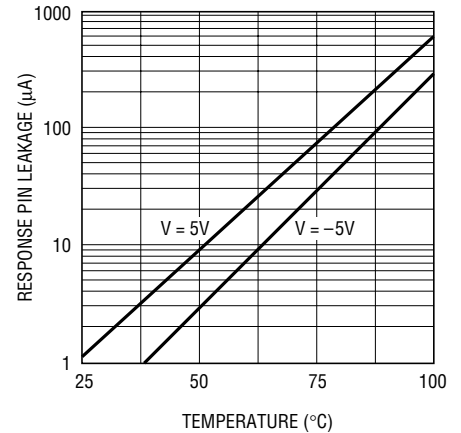

LT1032 • G06

ON/OFF Pin Current vs Voltage

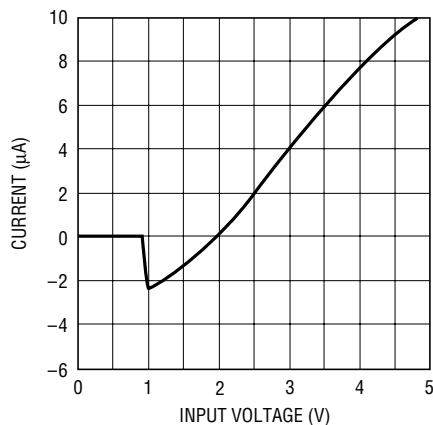

LT1032 • TPC07

Shutdown Pin Voltage vs Temperature

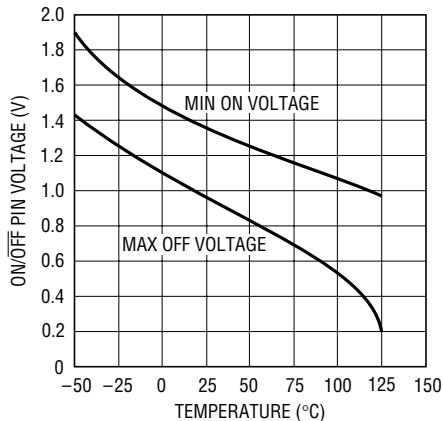

LT1032 • TPC08

Current Limit vs Temperature

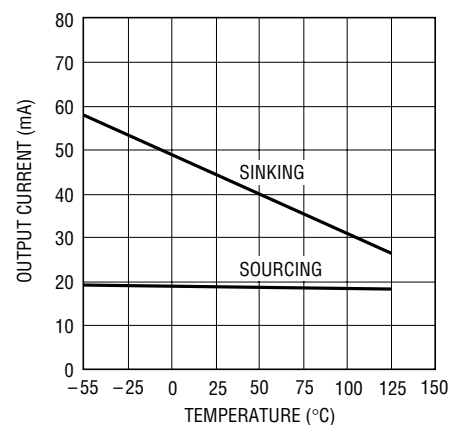

LT1032 • TPC09

TYPICAL PERFORMANCE CHARACTERISTICS

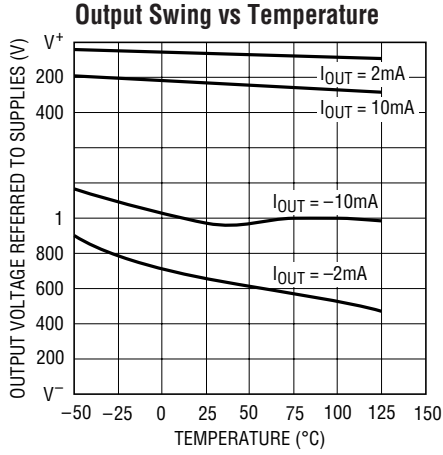

LT1032 • TPC10

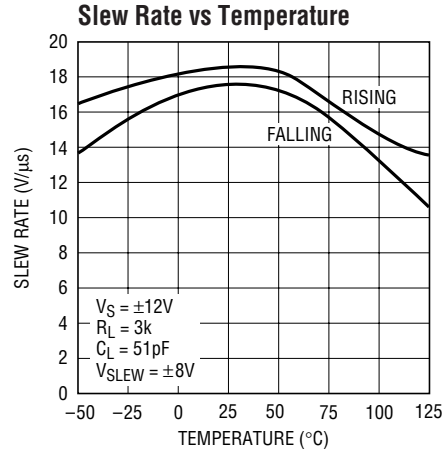

LT1032 • TPC11

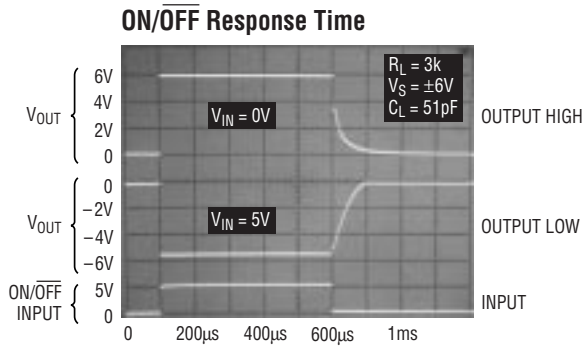

LT1032 • TPC12

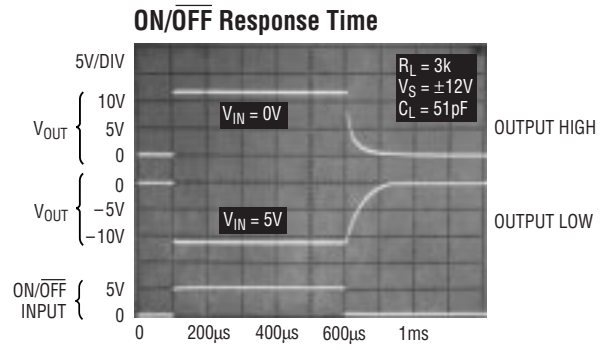

LT1032 • TPC13

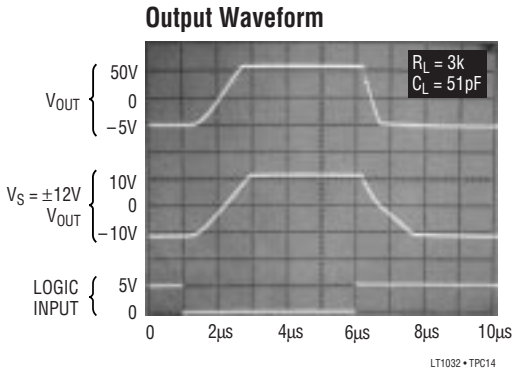

LT1032 • TPC14

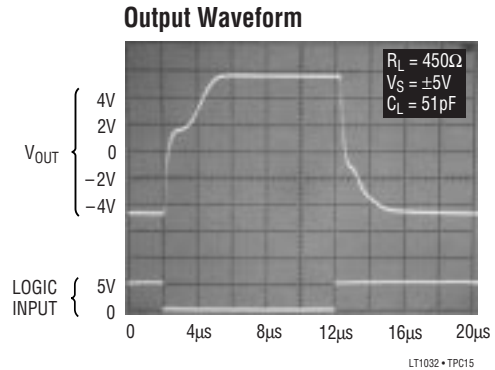

LT1032 • TPC15

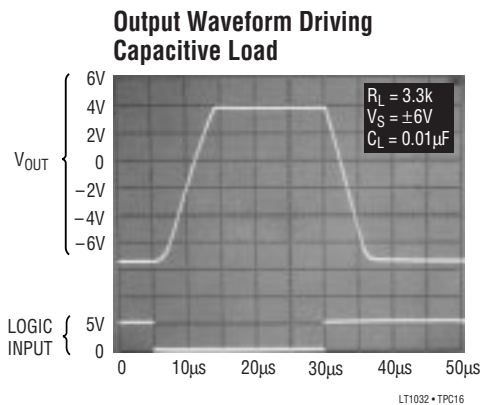

LT1032 • TPC16

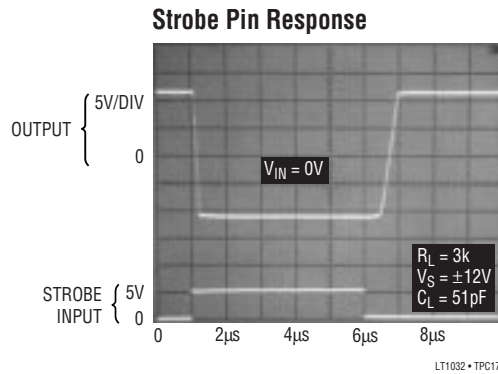

LT1032 • TPC17

PIN FUNCTIONS

V_{EE} (J, N & S: Pin 1): Minus Supply. Operates -2V to -15V.
(J & N: Pins 2, 5, 9, 12/S: Pins 2, 5, 11, 14): Logic Input. Operates properly on TTL or CMOS levels. Output valid form $(V^- + 2V) \leq V_{IN} \leq 15V$. Connect to ground when not used.

(J & N: Pins 3, 6, 8, 11/S: Pins 3, 6, 10, 13): Output. Line drive output.

ON/OFF (J, N & S: Pin 4): Shuts down entire circuit. Cannot be left open. For "normally on" operation, connect to V⁺.

GND (J, N & S: Pin 7): Ground. Ground must be more positive than V⁻.

Response Control (J & N: Pin 10/S: Pin 12): Allows limited change of slew rate. Leave open when not used.

Strobe (J & N: Pin 13/S: Pin 15): Forces all outputs low. Drive with 3V.

V_{CC} (J & N: Pin 14/S: Pin 15): Positive Supply. Operates 5V to 15V.

APPLICATIONS INFORMATION

Application Hints

The LT1032 is exceptionally easy to use when compared to older drivers. Operating supply voltage can be as low as ±3V or as high as ±15V. Input levels are referred to ground.

The logic inputs are internally set at TTL levels. Outputs are valid for input voltages from 1V above V⁻ to 25V. Driving the logic inputs to V⁻ turns off the output stage. The ON/OFF control completely turns off all supply current of the LT1032. The levels required to drive the device on or off are set by internal emitter-based voltages. Since the current into the ON/OFF pin is so low, TTL or CMOS drivers have no problem controlling the device.

The strobe pin is not fully logic compatible. The impedance of the strobe pin is about 2kΩ to ground. Driving the strobe pin positive forces the output stages low—even if the device is shut off. Under worst case conditions, 3V minimum at 2mA are needed driving the strobe pin to insure strobing.

The response pin can be used to make some adjustment in slew rate. A resistor can be connected between the response pin and the power supplies to drive 50μA to 100μA into the pin. The response pin is a low impedance point operating at about 0.75V above ground. For supply voltage up to ±6V, current is turned off when the device is turned off. For higher supply voltages, a Zener should be connected in series with the resistor to limit the voltage applied to the response pin to 6V. Also, for temperatures above 100°C, using the response pin is not recommended. The leakage current into the response pin at high temperatures is excessive.

Outputs are well protected against shorts or externally applied voltage. Tested limits are ±30V, but the device can withstand external voltages up to breakdown of the transistors (typically about 50V). The LT1032 is usually immune to ESD up to 2500V on the outputs with no damage.

TYPICAL APPLICATIONS

Protecting Against More Than ±30V Output Overload

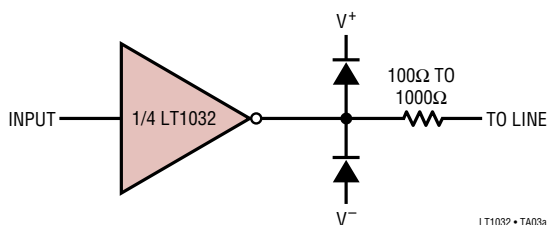

LT1032 • TA03a

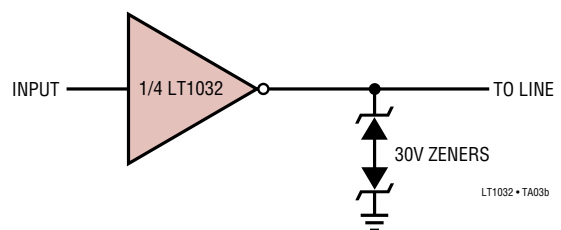

LT1032 • TA03b

TYPICAL APPLICATIONS

FET Driver

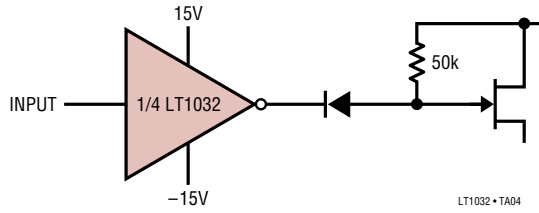

LT1032 • TA04

Slew Rate Adjustment*

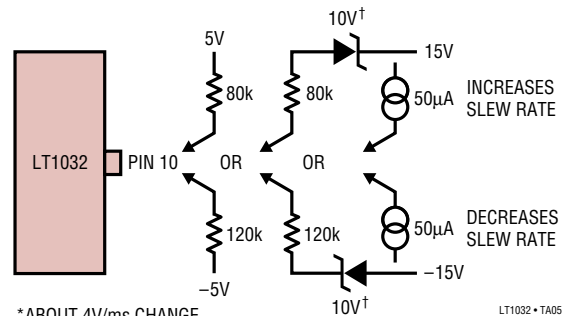

LT1032 • TA05

* ABOUT 4V/ms CHANGE
† ZENERS PREVENT LEAKAGE DURING SHUTDOWN

TTL/CMOS Compatible Strobe

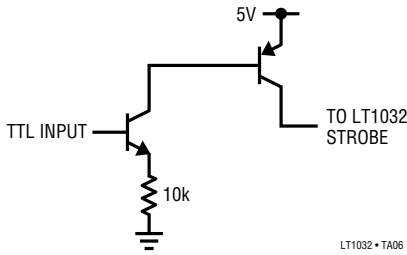

LT1032 • TA06

Strobing with CMOS

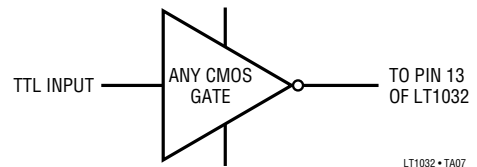

LT1032 • TA07

Phase Shift Oscillator

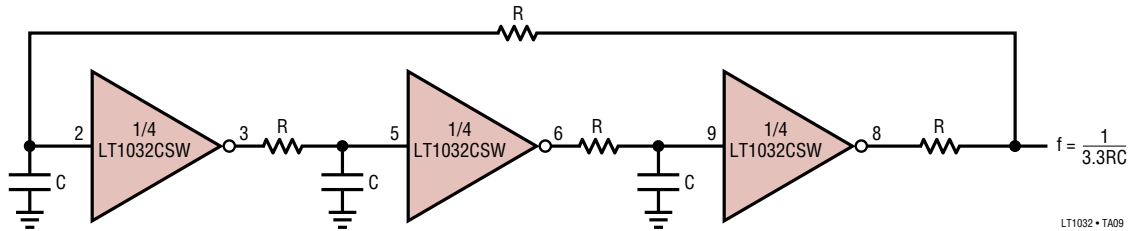

LT1032 • TA09

Operating from a Single 5V Supply

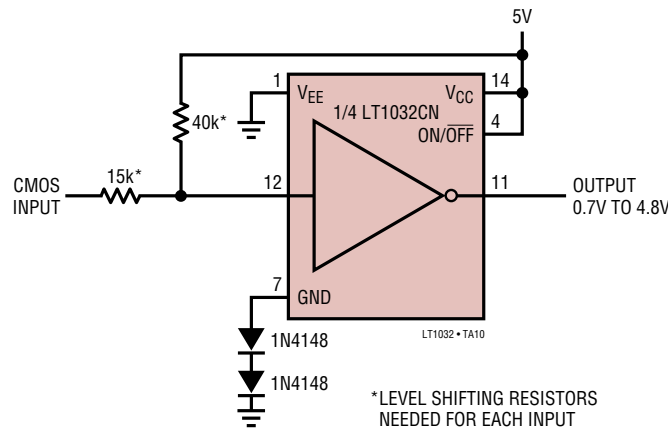

* LEVEL SHIFTING RESISTORS
NEEDED FOR EACH INPUT

TYPICAL APPLICATION

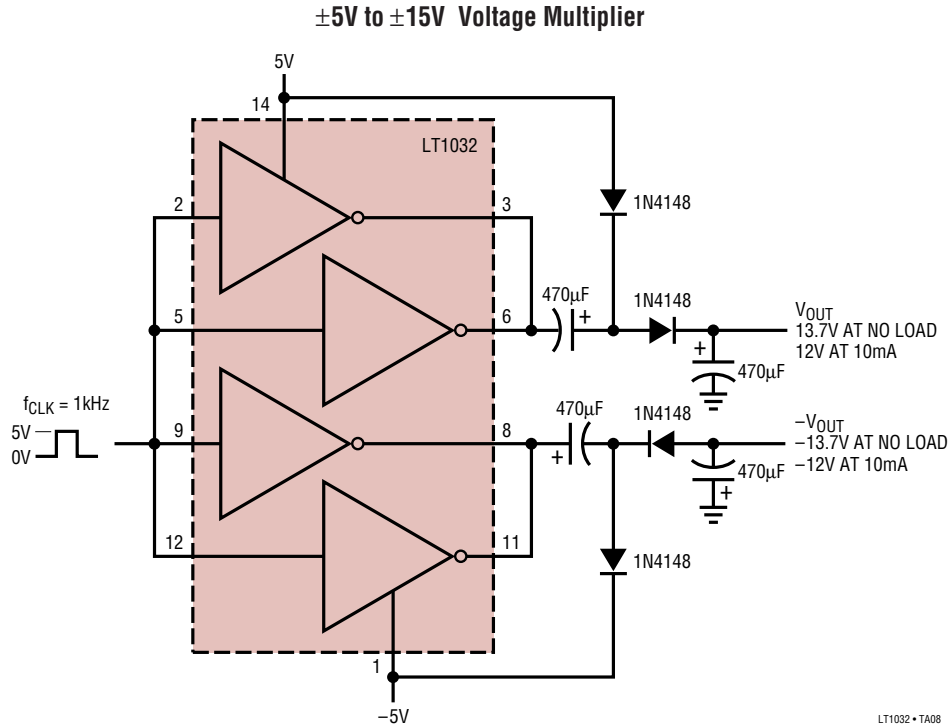

PACKAGE DESCRIPTION Dimensions in inches (millimeters) unless otherwise noted.

SW Package
16-Lead Plastic Small Outline (Wide 0.300)
 (LTC DWG # 05-08-1620)

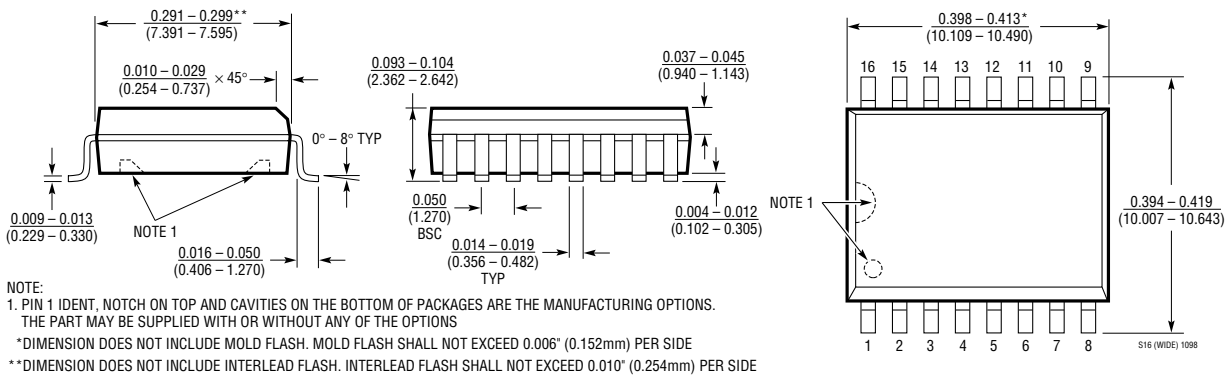

RELATED PARTS

PART NUMBER	DESCRIPTION	COMMENTS
LT1039A	Triple RS232 Driver/Receiver with Shutdown	±15kV ESD Protection
LT1130A/LT1140A	5V Supply, Multiple RS232 Driver/Receiver	±15kV 3 Driver/5 Receiver (LT1137A)
LT1780/LT1781A	5V Supply, 2 Driver/2 Receiver RS232	±15kV Pin Compatible Upgrade to LT1080/LT1081 and LT1180A/LT1181A