

4-Pin Green LED Lamp (7.6mm)

[查询"OVFSG6C8"供应商](#)

OVFSG6C8

- Packaged in tubes
- Compatible with automatic placement equipment
- Compatible with infrared and vapor phase reflow solder process
- Mono-color type
- Pb-free

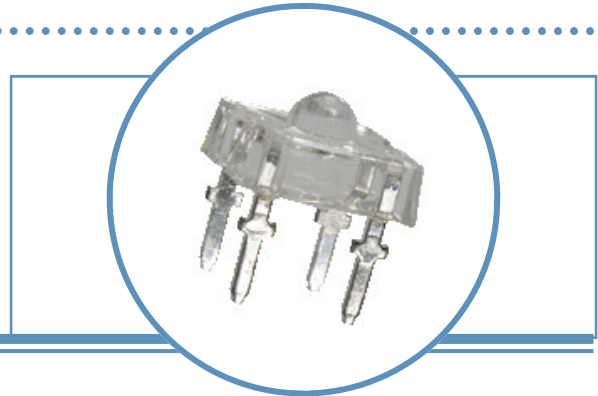

The OVFSG6C8 is designed with higher forward voltage to maximize brightness and incorporates a low-profile lens to enhance efficient light distribution. Response time is fast and it consumes less power resulting in low current requirements from circuit power supply. Tubular arrays replace neon in outdoor and indoor signs. This square package allows high-density arrays to form light engines.

Applications

- Automotive: Rear Stop/Turn Signal Lamps/Truck Marker Lamps
- Mood-setting Decoration and Landscape Lighting
 - Special Decorative Interior/Exterior Lighting
 - Special Effects Stage Lighting
- Illumination for Signs and Channel Letters
- Traffic Signals, Pedestrian and Walkway Signs

Part Number	Material	Emitted Color	Flux Typ. mlm	Lens Color
OVFSG6C8	InGaN	Green	2500	Water Clear

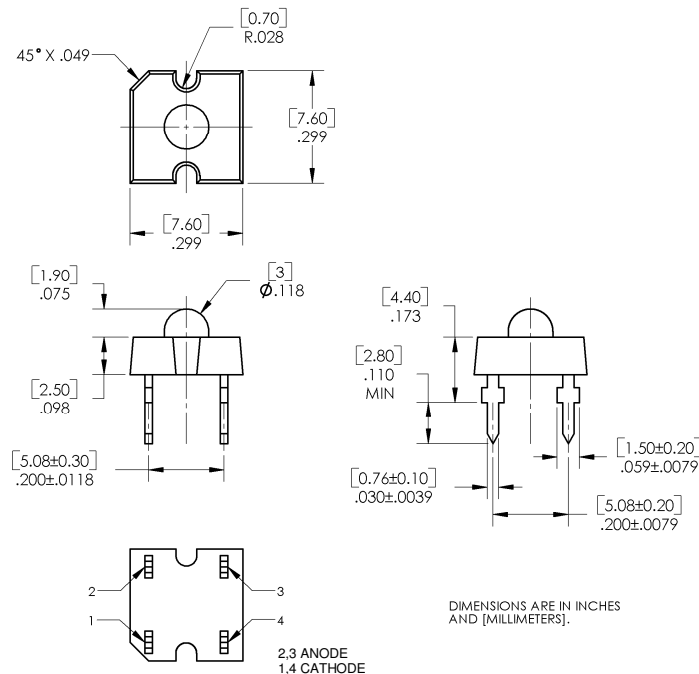

Data is subject to change without prior notice.

4-Pin Green LED Lamp (7.6mm)

OVFSG6C8
[查询"OVFSG6C8"供应商](#)



Absolute Maximum Ratings

$T_A = 25^\circ\text{C}$ unless otherwise noted

Storage Temperature Range	-40 ~ +100°C
Operating Temperature Range	-40 ~ +100°C
Lead Soldering Temperature (3mm from the base of the epoxy bulb) ¹	260°C
Reverse Voltage	5 V
Continuous Forward Current ²	30 mA
Peak Forward Current (10% Duty Cycle, PW ≤ 100 μsec)	100 mA
Power Dissipation	140 mW

Notes:

- Solder time less than 3 seconds at temperature extreme.

Electrical Characteristics

$T_A = 25^\circ\text{C}$ unless otherwise noted

SYMBOL	PARAMETER	MIN	TYP	MAX	UNITS	CONDITIONS
lumen	Luminous Flux	1500	2500	----	mlm	$I_F = 30\text{mA}$
V_F	Forward Voltage	----	4.0	4.6	V	$I_F = 30\text{mA}$
I_R	Reverse Current	----	----	100	μA	$V_R = 5\text{V}$
λ_D	Dominant Wavelength	515	527	535	nm	$I_F = 30\text{mA}$
$2\theta_{1/2}$	50% Power Angle	----	60	----	deg	$I_F = 30\text{mA}$

Standard Bins ($I_F = 30\text{mA}$)

Lamps are sorted to luminous flux (Φ_V), forward voltage (V_F), and dominant wavelength (λ_D) bins shown. Orders for OVFSG6C8 may be filled with any or all bins contained as below.

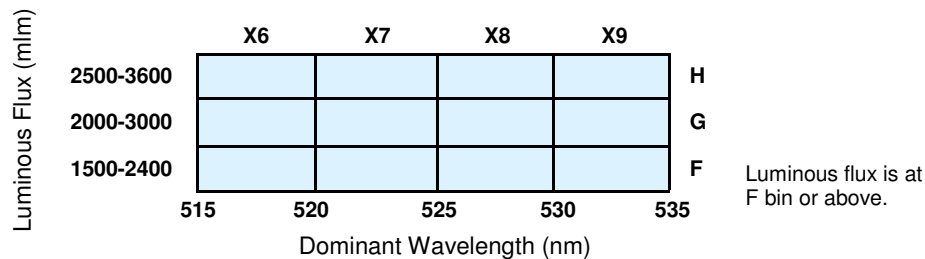

Forward Voltage (V_F)

Rank	V9	V10	V11	V12	V13	V14	V15
Voltage (V)	3.2–3.4	3.4–3.6	3.6–3.8	3.8–4.0	4.0–4.2	4.2–4.4	4.4–4.6

Important Notes:

- All ranks will be included per delivery, rank ratio will be based on the chip distribution.
- To designate luminous intensity ranks, please contact OPTEK.

4-Pin Green LED Lamp (7.6mm)

OVFSG6C8
[查询"OVFSG6C8"供应商](#)



Typical Electro-Optical Characteristics Curves

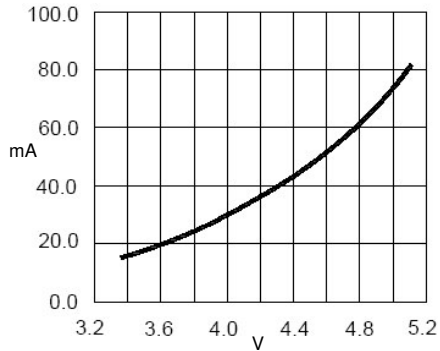

Forward Current vs. Forward Voltage

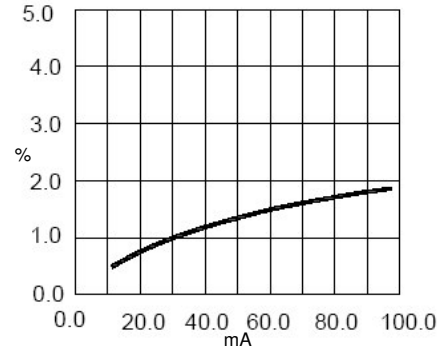

Relative Luminous Flux vs. Forward Current

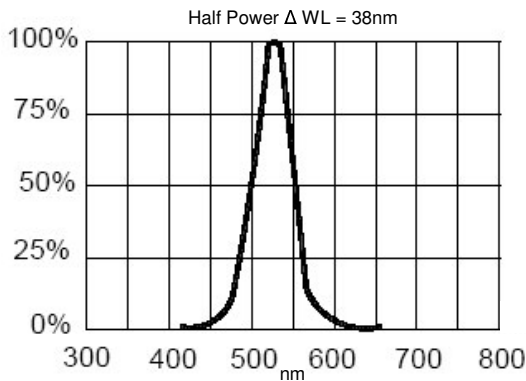

Relative Luminous Flux vs. Wavelength

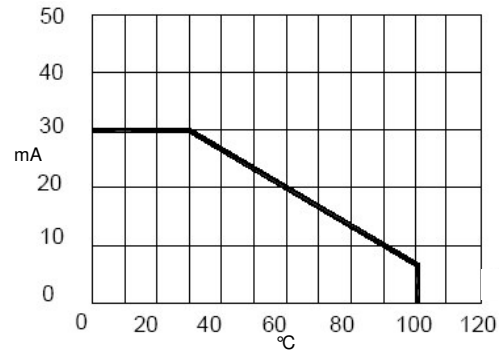

Maximum Forward DC Current vs. Ambient Temperature

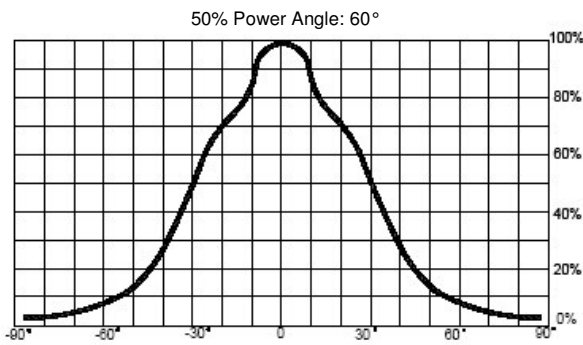

Far Field Pattern

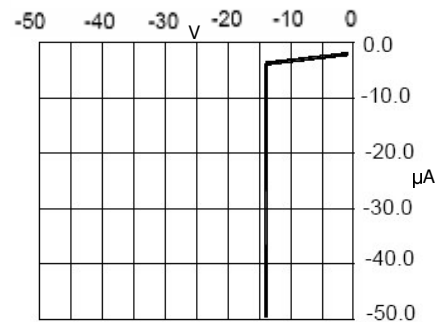

Reverse Current vs. Reverse Voltage

4-Pin Green LED Lamp (7.6mm)

查询"OVFSG6C8"供应商
OVFSG6C8

Moisture Resistant Packaging

