

DATA SHEET

SKY65004: 250 – 2700 MHz Linear Power Amplifier Driver

Applications

- UHF TV broadcasts
- TETRA radios
- GSM450, GSM480, GSM750 handsets
- AMPS, PCS, DCS, 2.5G, 3G handsets
- ISM band transmitters
- WCS fixed wireless
- 802.11b/g WLANs

Features

- Wideband frequency range: 250 to 2700 MHz
- High linearity: OIP3 > +40 dBm and P1dB > +24 dBm
- High efficiency: PAE = 48%
- High gain: 20 dB
- Single DC supply, +3 V or +5 V
- Available as an SMT SOT-89 (4-pin, 2.4 x 4.5 mm) package (SKY65004-11 option) or Pb-free MCM (3-pin, 4 x 4 mm) package (SKY65004-21 option)

Description

Skyworks SKY65004 is a high performance, ultra-wideband amplifier with superior output power, linearity, and efficiency. The device is fabricated using Skyworks high reliability Aluminum Gallium Arsenide (AlGaAs) Heterojunction Bipolar Transistor (HBT) technology.

The SKY65004 achieves a high linearity and superior Adjacent Channel Power Rejection/Adjacent Channel Leakage Ratio (ACPR/ACLR) performance. This makes it ideal for use in the driver stage of infrastructure transmit chains for Trans-European Trunked Radio (TETRA) transceivers, multi-band (GSM, AMPS, PCS, DCS) handsets, and many other wireless applications.

The SKY65004 uses low-cost Surface-Mount Technology (SMT) in the form of a 4-pin, 2.4 x 4.5 mm Small Outline Transistor (SOT) package (-21 option) or a Pb-free 3-pin, 4 x 4 mm Multi-Chip Module (MCM) package (-21 option), pin-compatible with the SKY65004-11. The device packages and pinouts are shown in Figures 1 and 2.

NEW

Skyworks offers lead (Pb)-free RoHS (Restriction of Hazardous Substances) compliant packaging.

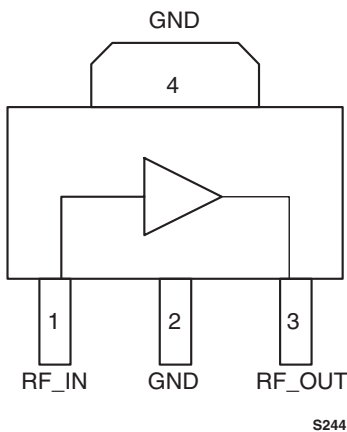

Figure 1. SKY65004-11 Pinout – 4-Pin SOT-89 Package (Top View)

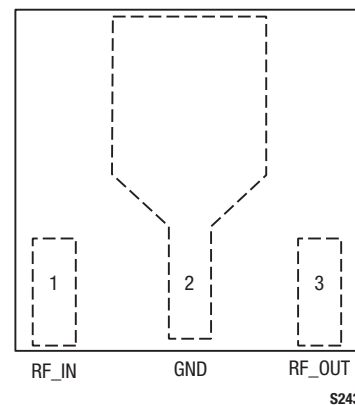

Figure 2. SKY65004-21 Pinout – 3-Pin MCM Package (Top View)

[查询"SKY65004"供应商](#)

Electrical and Mechanical Specifications

Signal pin assignments and functional pin descriptions are provided in Table 1. The absolute maximum ratings of the SKY65004 are provided in Table 2 and the recommended operating conditions provided in Table 3. Electrical characteristics of the SKY65004 are provided in Table 4.

The typical performance of the SKY65004 is illustrated in Figures 3 through 13. Package dimensions for the 4-pin SOT-89 option are provided in Figure 17, and tape and reel dimensions are shown in Figure 18. Package dimensions for the 3-pin MCM option are shown in Figure 19, and tape and reel dimensions are shown in Figure 20.

Package and Handling Information

Since the device package is sensitive to moisture absorption, it is baked and vacuum packed before shipping. Instructions on the shipping container label regarding exposure to moisture after the container seal is broken must be followed. Otherwise, problems related to moisture absorption may occur when the part is subjected to high temperature during solder assembly.

The SKY65004 PA driver is available in two different package options based on package type. The -21 MCM option is a Pb-free package rated to Moisture Sensitivity Level 3 (MSL3) at 250 °C. It can be used for lead or lead-free soldering

If the part is attached in a reflow oven, the temperature ramp rate should not exceed 5 °C per second. Maximum temperature should not exceed 225 °C and the time spent at a temperature that exceeds 210 °C should be limited to less than 10 seconds. If the part is manually attached, precaution should be taken to ensure that the part is not subjected to a temperature that exceeds 300 °C for more than 10 seconds.

For details on both attachment techniques, precautions, and handling procedures recommended by Skyworks, please refer to Skyworks Application Note, *PCB Design and SMT Assembly/Rework Guidelines for MCM-L Packages*, document number 101752. Additional information on standard SMT reflow profiles can also be found in the JEDEC Standard J-STD-020.

Production quantities of both package types for this product are shipped in standard tape and reel formats. For packaging details, refer to the Skyworks Application Note, *Tape and Reel*, document number 101568.

Electrostatic Discharge (ESD) Sensitivity

The SKY65004 is a static-sensitive electronic device. Do not operate or store near strong electrostatic fields. Take proper ESD precautions.

Table 1. SKY65004 Signal Descriptions

Pin #	Name	Description
1	RF_IN	RF input
2	GND	Ground
3	RF_OUT	RF output
4 (SOT-89 package only)	GND	Ground

Table 2. SKY65004 Absolute Maximum Ratings

(T_A = +25 °C, unless otherwise noted)

Parameter	Symbol	Min	Typical	Max	Units
Supply voltage	VCC			6	V
RF output power	P _{OUT}			27	dBm
Supply current	I _{CC}			160	mA
Power dissipation	P _D			1.2	W
Operating case temperature	T _C	-40		+85	°C
Storage temperature	T _{ST}	-55		+125	°C
Junction temperature	T _J			150	°C

Note: Exposure to maximum rating conditions for extended periods may reduce device reliability. There is no damage to device with only one parameter set at the limit and all other parameters set at or below their nominal values.

[查询"SKY65004"供应商](#)**Table 3. SKY65004 Recommended Operating Conditions**

Parameter	Symbol	Min	Typical	Max	Units
Supply voltage	VCC		5		V
Frequency range	F	250		2700	MHz
Junction temperature	T _J			+140	°C

Table 4. SKY65004 Electrical Characteristics (1 of 2)**(VCC = 5 V, T_c = 25 °C, input load < -8 dB, unless otherwise noted)**

Parameter	Symbol	Test Conditions	Min	Typical	Max	Units
Test Frequency = 450 MHz						
Small signal gain	G	CW		27		dB
Output power @ 1 dB compression	P _{1dB}	CW		24		dBm
Output 3rd Order Intercept Point	OIP3	Two tones, each @ +7 dBm output power		42		dBm
Test Frequency = 900 MHz						
Small signal gain	G	CW		22		dB
Output power @ 1 dB compression	P _{1dB}	CW		24		dBm
Output 3rd Order Intercept Point	OIP3	Two tones, each @ +7 dBm output power		42		dBm
Noise Figure	NF			4.0		dB
Output power @ ACPR = -45 dBc, 750 kHz offset	P _{OUT}	IS-95. Nine forward channels		18		dBm
Test Frequency = 1960 MHz						
Small signal gain	G	CW	14.5	16.0		dB
Output power @ 1 dB compression	P _{1dB}	CW	23	25		dBm
Output 3rd Order Intercept Point	OIP3	Two tones, each @ +7 dBm output power	39	42		dBm
Noise Figure	NF			5.5	6.5	dB
Power Added Efficiency	PAE	CW @ P _{OUT} = P _{1dB}	42	48		%
Supply current	I _S			125	145	mA
Output power @ ACPR = -45 dBc, 885 kHz offset	P _{OUT}	IS-95. Nine forward channels	17	19		dBm
Test Frequency = 2140 MHz						
Small signal gain	G	CW		15		dB
Output power @ 1 dB compression	P _{1dB}	CW		25		dBm
Output 3rd Order Intercept Point	OIP3	Two tones, each @ +7 dBm output power		42		dBm
Output power @ ACLR = -45 dBc, 5 MHz offset	P _{OUT}	WCDMA. Test model #1; 64 DPCH		17		dBm

[查询"SKY65004"供应商](#)

Table 4. SKY65004 Electrical Characteristics (2 of 2)

(VCC = 5 V, Tc = 25 °C, input load < -8 dB, unless otherwise noted)

Parameter	Symbol	Test Conditions	Min	Typical	Max	Units
Test Frequency = 2450 MHz						
Small signal gain	G	CW		14.5		dB
Output power @ 1 dB compression	P1dB	CW		25		dBm
Output 3rd Order Intercept Point	OIP3	Two tones, each @ +7 dBm output power		42		dBm
Noise Figure	NF			5.0		dB
Power Added Efficiency	PAE	CW, Pout = +26 dBm		50		%
Test Frequency = 2600 MHz						
Small signal gain	G	CW		14		dB
Output power @ 1 dB compression	P1dB	CW		25		dBm
Output 3rd Order Intercept Point	OIP3	Two tones, each @ +7 dBm output power		41		dBm

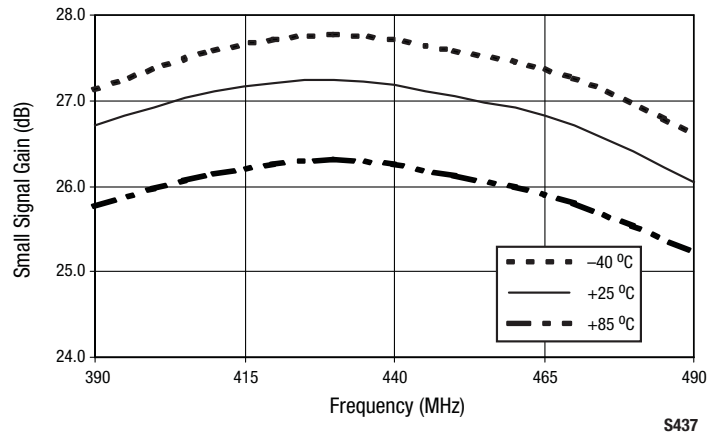

Figure 3. Typical Small Signal Gain From 390 to 490 MHz Over Temperature

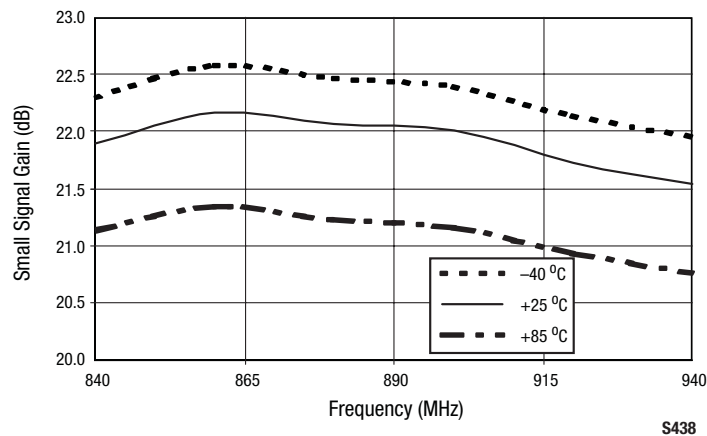

Figure 4. Typical Small Signal Gain From 840 to 940 MHz Over Temperature

[查询"SKY65004"供应商](#)

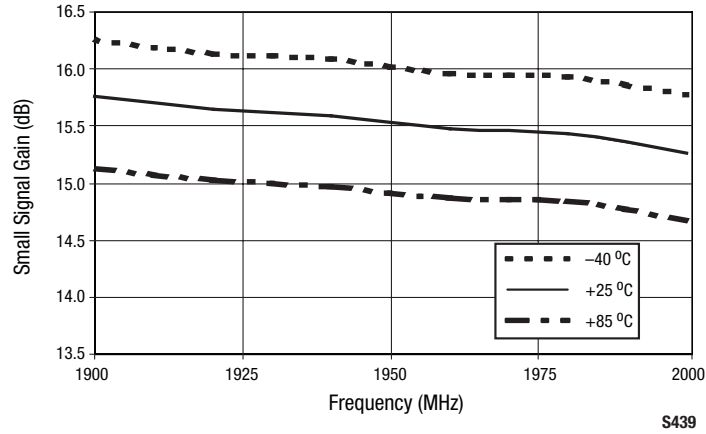

Figure 5. Typical Small Signal Gain From 1900 to 2000 MHz Over Temperature

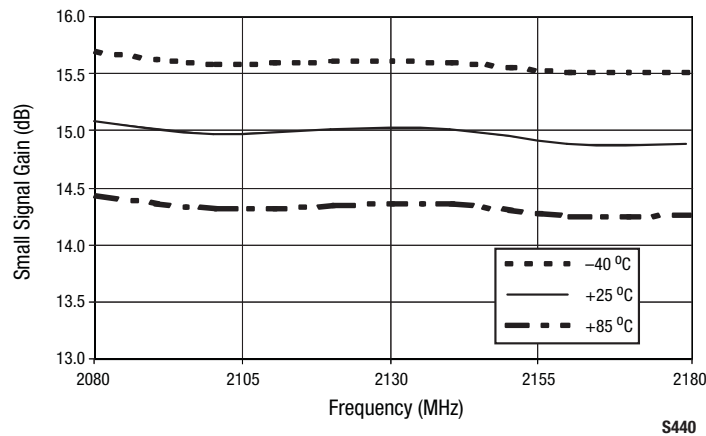

Figure 6. Typical Small Signal Gain From 2080 to 2180 MHz Over Temperature

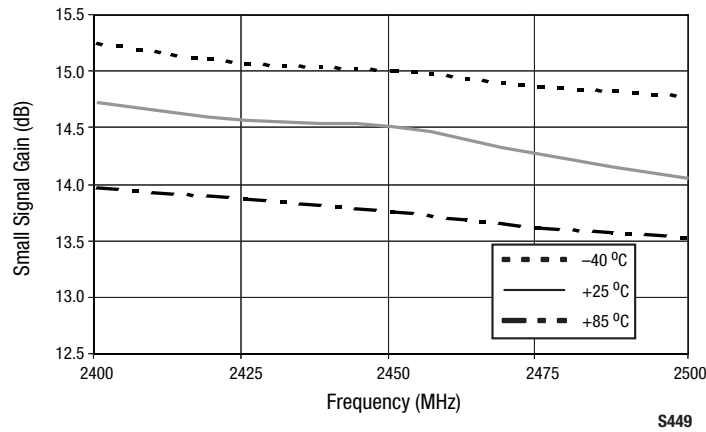
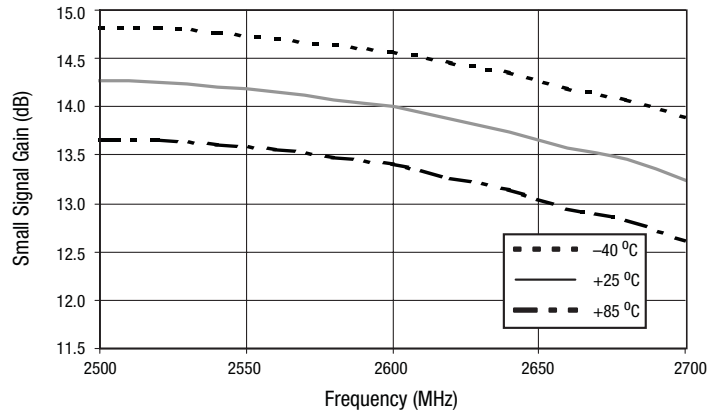

Figure 7. Typical Small Signal Gain From 2400 to 2500 MHz Over Temperature

[查询"SKY65004"供应商](#)



S450

Figure 8. Typical Small Signal Gain From 2500 to 2700 MHz Over Temperature

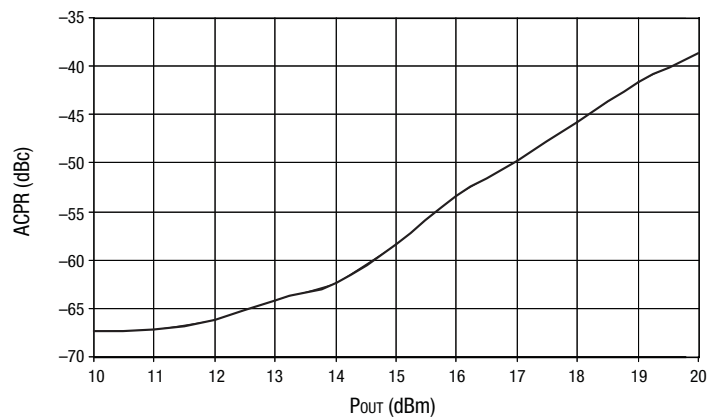

S441

Figure 9. Typical ACPR vs Pout @ 900 MHz, 750 kHz Offset, and 25 °C

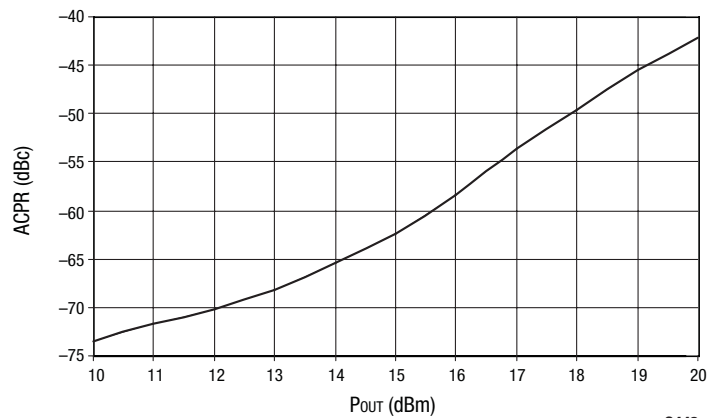

S442

Figure 10. Typical ACPR vs Pout @ 1960 MHz, 885 kHz Offset, and 25 °C

[查询"SKY65004"供应商](#)

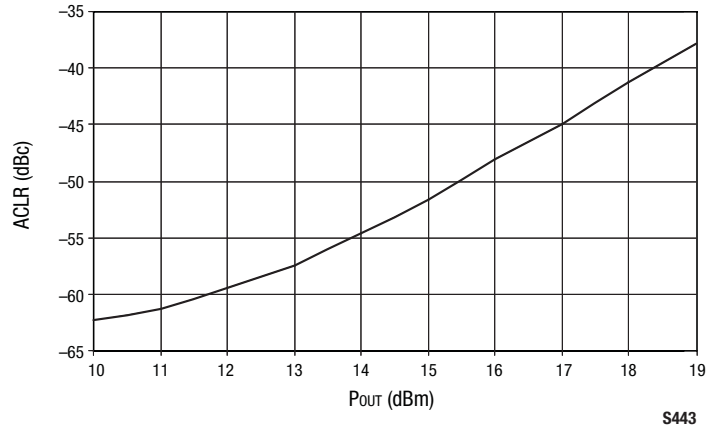

Figure 11. Typical ACLR vs Pout @ 2140 MHz, 5 MHz Offset, and 25 °C

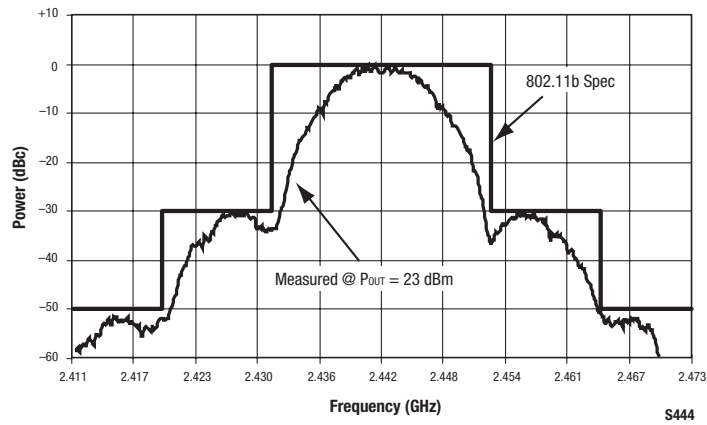

Figure 12. Spectral Response With 802.11b Signal (CCK @ 11 Mbps, VCC = 3.3 V)

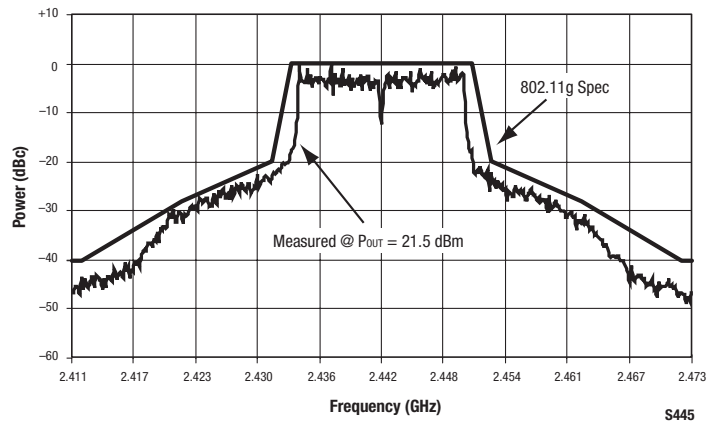

Figure 13. Spectral Response With 802.11g Signal (64-QAM @ 54 Mbps, VCC = 3.3 V)

[查询"SKY65004"供应商](#)

Evaluation Board Description

The Skyworks SKY65004 Evaluation Board is used to test the performance of the SKY65004 power amplifier driver. An assembly drawing for the Evaluation Board is shown in Figure 14 and the layer detail is provided in Figure 15.

Circuit Design Configurations

The following design considerations are general in nature and must be followed regardless of final use or configuration.

1. Paths to ground should be made as short as possible.
2. The ground pad of the SKY65004 power amplifier has special electrical and thermal grounding requirements. This pad is the main thermal conduit for heat dissipation. Since the circuit board acts as the heat sink, it must shunt as much heat as possible from the amplifier. As such, design the connection to the ground pad to dissipate the maximum wattage produced to the circuit board. Multiple vias to the grounding layer are required.

NOTE: Junction temperature (T_j) of the device increases with a poor connection to the slug and ground. This reduces the lifetime of the device.

A suggested matching circuit is shown in Figure 16 with component values for the SKY65004-11 package option listed in

Table 5. Component values for the SKY65004-21 package option are shown in Table 6.

Testing Procedure

Use the following procedure to set up the SKY65004 Evaluation Board for testing:

1. Connect a 5.0 V supply to VCC. If available, enable the current limiting function of the power supply to 240 mA.
2. Connect a signal generator to the RF signal input port. Set it to the desired RF frequency at a power level of -15 dBm or less to the Evaluation Board but do NOT enable the RF signal.
3. Connect a spectrum analyzer to the RF signal output port.
4. Enable the power supply.
5. Enable the RF signal.
6. Take measurements.

CAUTION: *If any of the output signals exceed the rated maximum values, the SKY65004 Evaluation Board can be permanently damaged.*

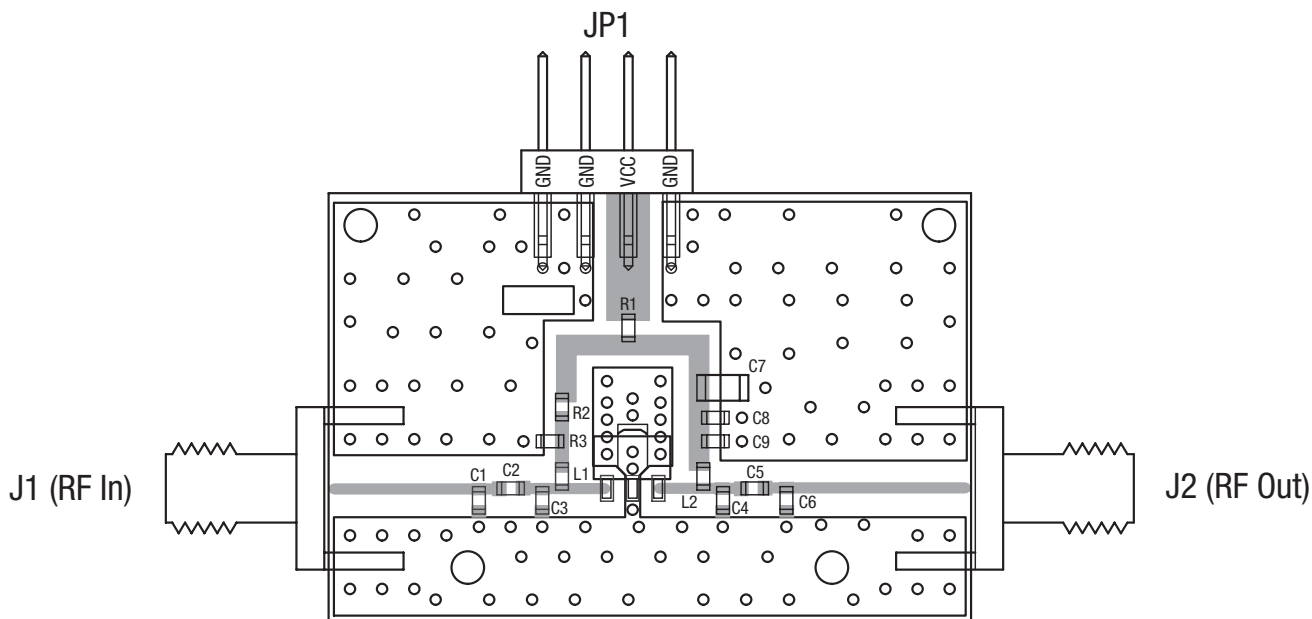

S446

Figure 14. Evaluation Board Assembly Drawing

[查询"SKY65004"供应商](#)

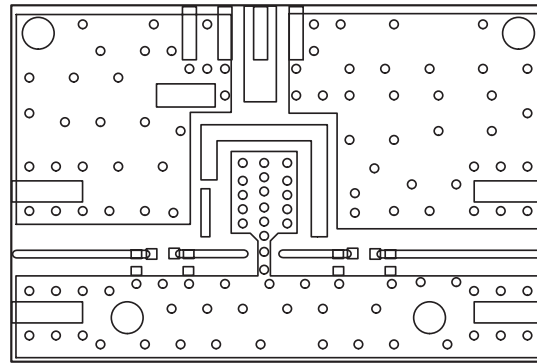

Layer 1: Top - Metal

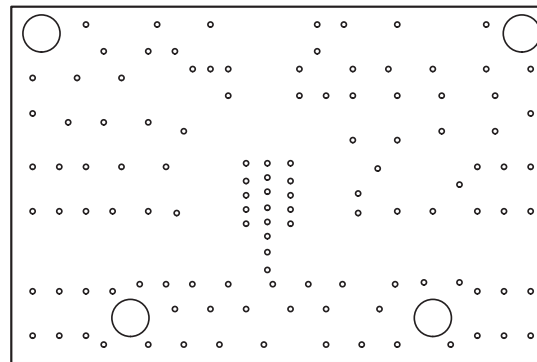

Layer 2: Ground

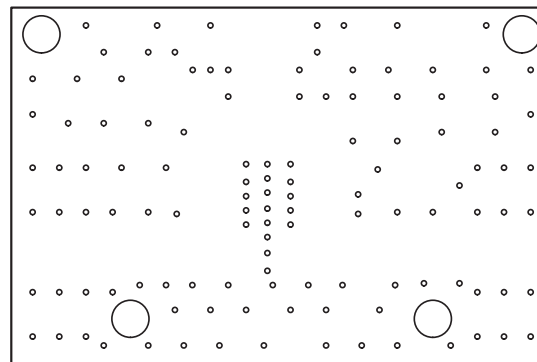

Layer 3: Ground

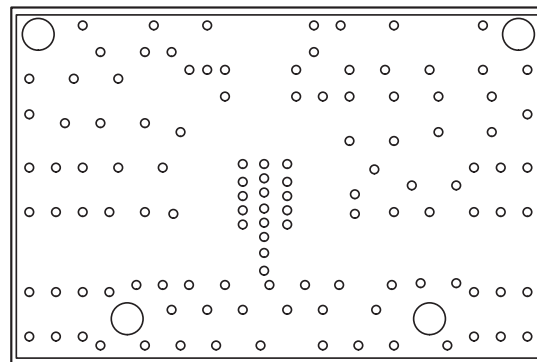

Layer 4: Solid Ground Plane

S447

Figure 15. Evaluation Board Layer Detail

[查询"SKY65004"供应商](#)

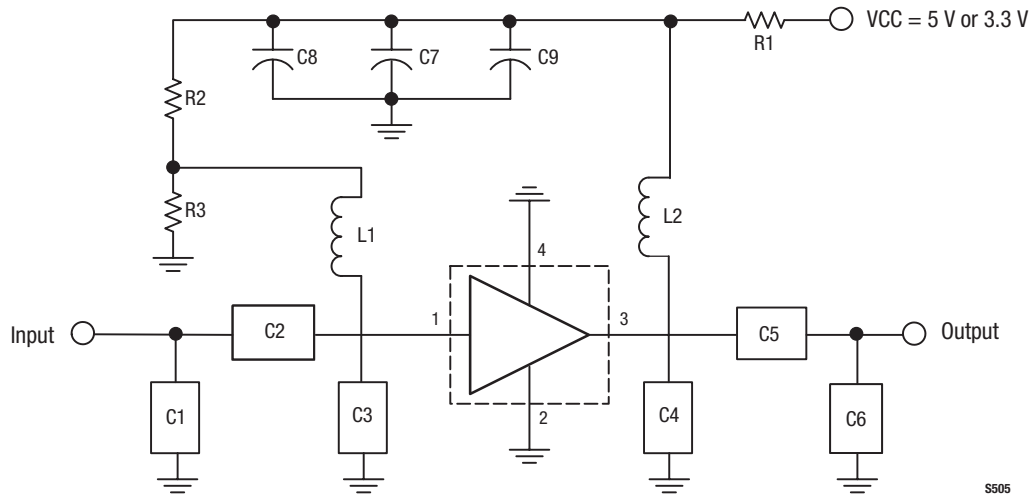

Figure 16. SKY65004 Evaluation Board Schematic
(Refer to Tables 5 and 6 for Component Values)

Table 5. SKY65004-11 (SOT-89 Package) Evaluation Board Component Values vs Frequency

Component Label	Evaluation Board Frequency (MHz)						
	450	900	1960	2140	2450	2450	2600
	VCC = 5 V					VCC = 3.3 V	VCC = 5 V
Input Match							
C1	6.8 nH	6.8 nH	15 nH	6.8 nH	1 pF	1 pF	1 pF
C2	15 pF	6.8 pF	12 pF	1 pF	1.5 pF	1.5 pF	1.2 pF
C3	DNC	10 pF	1.5 pF	1 pF	DNC	DNC	DNC
Output Match							
C4	DNC	DNC	DNC	2.2 pF	DNC	DNC	DNC
C5	22 pF	10 pF	2.2 pF	3.3 pF	20 pF	20 pF	20 pF
C6	0.5 pF	8.2 nH	3.9 nH	2.2 nH	0.5 pF	0.5 pF	0.5 pF
Bypass Capacitors							
C7	1000 pF	1000 pF	1000 pF	1000 pF	1000 pF	1000 pF	1000 pF
C8	0.1 μF	0.1 μF	0.1 μF	0.1 μF	0.1 μF	0.1 μF	0.1 μF
C9	68 pF	68 pF	18 pF	18 pF	18 pF	18 pF	18 pF
Bias Chokes							
L1	39 nH	39 nH	27 nH	27 nH	27 nH	27 nH	22 nH
L2	39 nH	39 nH	27 nH	27 nH	27 nH	27 nH	22 nH
Bias Resistors							
R1	0 Ω	0 Ω	0 Ω	0 Ω	0 Ω	0 Ω	0 Ω
R2	390 Ω	390 Ω	390 Ω	390 Ω	390 Ω	220 Ω	390 Ω
R3	180 Ω	180 Ω	180 Ω	180 Ω	180 Ω	200 Ω	180 Ω

Note: DNC = Do Not Connect

[查询"SKY65004"供应商](#)**Table 6. SKY65004-21 (MCM Package) Evaluation Board Component Values vs Frequency**

Component Label	Evaluation Board Frequency (MHz)						
	450	900	1960	2140	2450	2450	2600
	VCC = 5 V					VCC = 3.3 V	VCC = 5 V
Input Match							
C1	6.8 nH	6.8 nH	5.6 nH	6.8 nH	0.5 pF	0.5 pF	0.5 pF
C2	15 pF	6.8 pF	1 pF	1 pF	1 pF	1 pF	1 pF
C3	DNC	10 pF	1 pF	0.5 pF	DNC	DNC	DNC
Output Match							
C4	DNC	DNC	DNC	2.7 pF	DNC	DNC	DNC
C5	330 pF	8.2 pF	22 pF	2.7 pF	20 pF	20 pF	20 pF
C6	56 pF	8.2 nH	0.5 pF	2.2 nH	0.5 pF	0.5 pF	0.5 pF
Bypass Capacitors							
C7	1000 pF	1000 pF	1000 pF	1000 pF	1000 pF	1000 pF	1000 pF
C8	0.1 μ F	0.1 μ F	0.1 μ F	0.1 μ F	0.1 μ F	0.1 μ F	0.1 μ F
C9	68 pF	68 pF	18 pF	18 pF	18 pF	18 pF	18 pF
Bias Chokes							
L1	39 nH	39 nH	27 nH	27 nH	27 nH	27 nH	27 nH
L2	39 nH	39 nH	27 nH	27 nH	27 nH	27 nH	27 nH
Bias Resistors							
R1	0 Ω	0 Ω	0 Ω	0 Ω	0 Ω	0 Ω	0 Ω
R2	390 Ω	390 Ω	390 Ω	390 Ω	390 Ω	220 Ω	390 Ω
R3	180 Ω	180 Ω	180 Ω	180 Ω	180 Ω	200 Ω	180 Ω

Note: DNC = Do Not Connect

[查询"SKY65004"供应商](#)

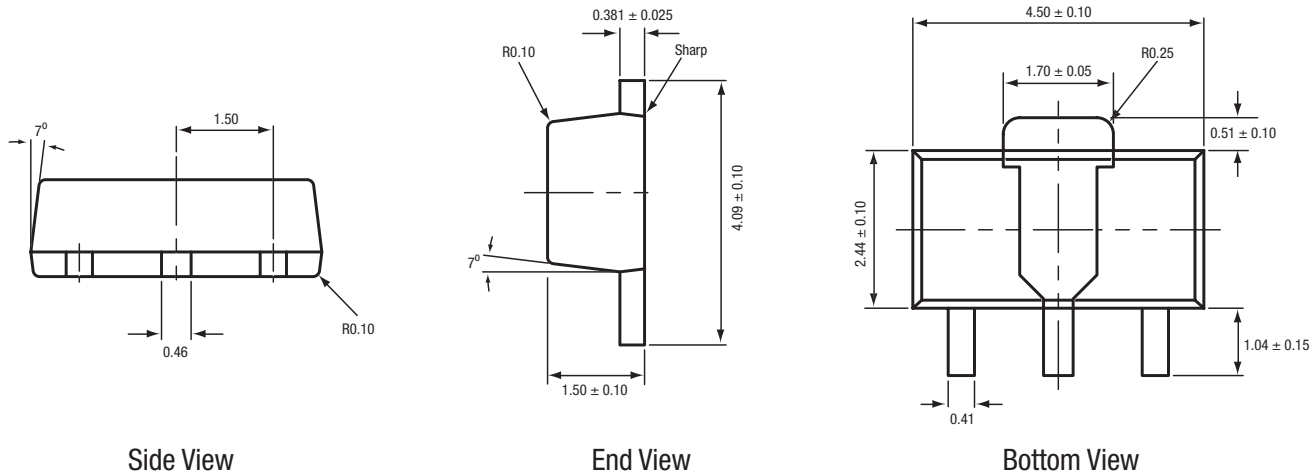

All measurements are in millimeters

S253

Figure 17. SKY65004-11 (4-Pin SOT-89) Package Dimensions

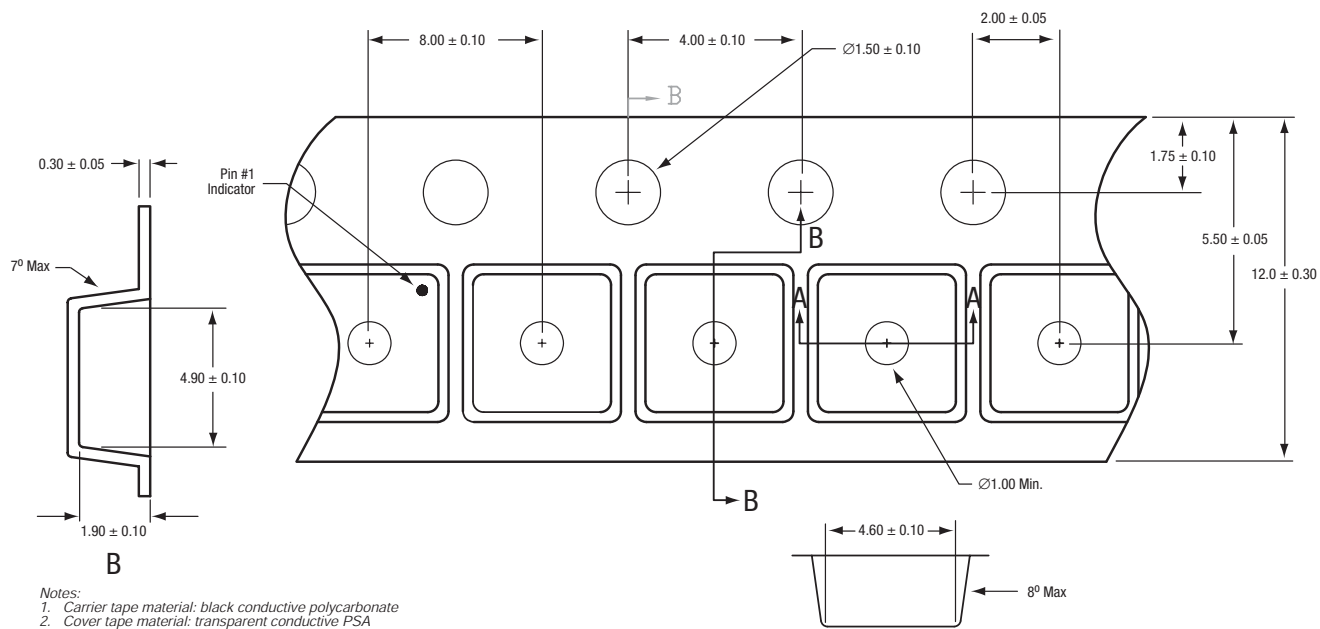

- Notes:
1. Carrier tape material: black conductive polycarbonate
 2. Cover tape material: transparent conductive PSA
 3. Cover tape size: 9.2 mm width
 4. All measurements are in millimeters

S264

Figure 18. SKY65004-11 (4-Pin SOT-89) Tape and Reel Dimensions

[查询"SKY65004"供应商](#)

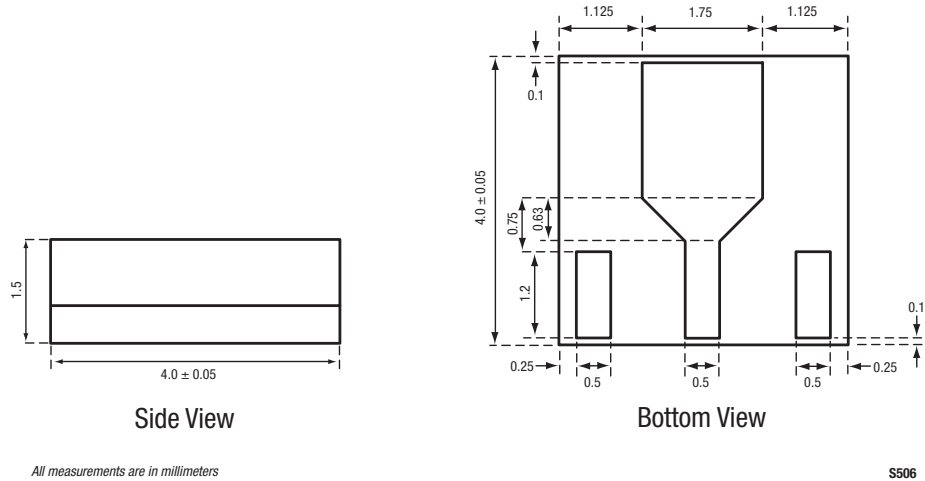

Figure 19. SKY65004-21 (3-Pin MCM) Package Dimensions

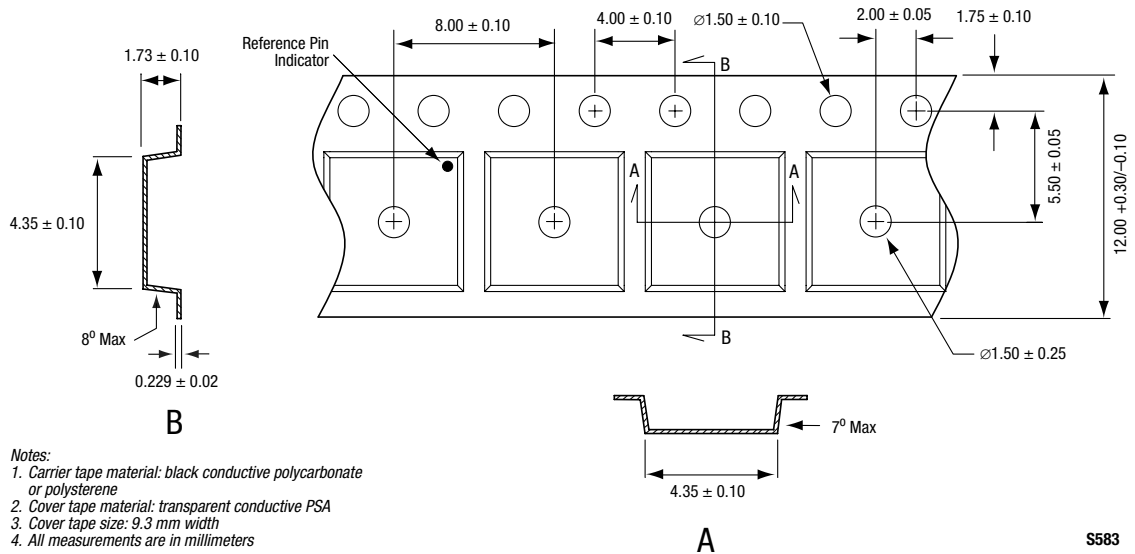

Figure 20. SKY65004-21 (3-Pin MCM) Tape and Reel Dimensions

[查询"SKY65004"供应商](#)

Ordering Information

Model Name	Ordering Part Number	Evaluation Kit Part Number
SKY65004 250-2700 MHz Linear PA Driver (4-pin SOT-89 package)	SKY65004-11	TW11-D631 (900 MHz) TW11-D632 (1960 MHz) TW11-D633 (2140 MHz) TW11-D634 (450 MHz) TW11-D636 (2450 MHz, VCC = 5 V) TW11-D638 (2450 MHz, VCC = 3.3 V) TW11-D637 (2600 MHz)
SKY65004 250-2700 MHz Linear PA Driver (3-pin MCM package)	SKY65004-21 (Pb-free package)	TW13-D391-011 (450 MHz) TW13-D391-021 (900 MHz) TW13-D391-031 (1960 MHz) TW13-D391-041 (2140 MHz) TW13-D391-061 (2450 MHz, VCC = 3.3 V) TW13-D391-071 (2450 MHz, VCC = 5 V) TW13-D391-081 (2600 MHz)

Copyright © 2003, 2004, 2005, 2006 Skyworks Solutions, Inc. All Rights Reserved.

Information in this document is provided in connection with Skyworks Solutions, Inc. ("Skyworks") products or services. These materials, including the information contained herein, are provided by Skyworks as a service to its customers and may be used for informational purposes only by the customer. Skyworks assumes no responsibility for errors or omissions in these materials or the information contained herein. Skyworks may change its documentation, products, services, specifications or product descriptions at any time, without notice. Skyworks makes no commitment to update the materials or information and shall have no responsibility whatsoever for conflicts, incompatibilities, or other difficulties arising from any future changes.

No license, whether express, implied, by estoppel or otherwise, is granted to any intellectual property rights by this document. Skyworks assumes no liability for any materials, products or information provided hereunder, including the sale, distribution, reproduction or use of Skyworks products, information or materials, except as may be provided in Skyworks Terms and Conditions of Sale.

THE MATERIALS, PRODUCTS AND INFORMATION ARE PROVIDED "AS IS" WITHOUT WARRANTY OF ANY KIND, WHETHER EXPRESS, IMPLIED, STATUTORY, OR OTHERWISE, INCLUDING FITNESS FOR A PARTICULAR PURPOSE OR USE, MERCHANTABILITY, PERFORMANCE, QUALITY OR NON-INFRINGEMENT OF ANY INTELLECTUAL PROPERTY RIGHT; ALL SUCH WARRANTIES ARE HEREBY EXPRESSLY DISCLAIMED. SKYWORKS DOES NOT WARRANT THE ACCURACY OR COMPLETENESS OF THE INFORMATION, TEXT, GRAPHICS OR OTHER ITEMS CONTAINED WITHIN THESE MATERIALS. SKYWORKS SHALL NOT BE LIABLE FOR ANY DAMAGES, INCLUDING BUT NOT LIMITED TO ANY SPECIAL, INDIRECT, INCIDENTAL, STATUTORY, OR CONSEQUENTIAL DAMAGES, INCLUDING WITHOUT LIMITATION, LOST REVENUES OR LOST PROFITS THAT MAY RESULT FROM THE USE OF THE MATERIALS OR INFORMATION, WHETHER OR NOT THE RECIPIENT OF MATERIALS HAS BEEN ADVISED OF THE POSSIBILITY OF SUCH DAMAGE.

Skyworks products are not intended for use in medical, lifesaving or life-sustaining applications, or other equipment in which the failure of the Skyworks products could lead to personal injury, death, physical or environmental damage. Skyworks customers using or selling Skyworks products for use in such applications do so at their own risk and agree to fully indemnify Skyworks for any damages resulting from such improper use or sale. Customers are responsible for their products and applications using Skyworks products, which may deviate from published specifications as a result of design defects, errors, or operation of products outside of published parameters or design specifications. Customers should include design and operating safeguards to minimize these and other risks. Skyworks assumes no liability for applications assistance, customer product design, or damage to any equipment resulting from the use of Skyworks products outside of stated published specifications or parameters.

Skyworks, the Skyworks symbol, and "Breakthrough Simplicity" are trademarks or registered trademarks of Skyworks Solutions, Inc., in the United States and other countries. Third-party brands and names are for identification purposes only, and are the property of their respective owners. Additional information, including relevant terms and conditions, posted at www.skyworksinc.com, are incorporated by reference.