

CCFL Transformer Application Note

Cold Cathode Fluorescent Lamps (CCFLs) are used to illuminate Liquid Crystal Displays (LCDs). The LCD display is used in laptop computers, gas pumps, automobiles, test equipment, PDAs and medical instruments.

CCFLs are small, efficient and inexpensive. The lamp must be driven by a specialized power supply. High sinusoidal AC voltage is needed to start the lamps, but once started, the voltage drops to a lower level. CCFL circuits are usually powered from a low voltage DC source of 5-12V. The DC to AC power supply needs a transformer to change low DC input voltage to high sinusoidal AC voltage.

The Cooper Bussmann® Coiltronics® brand CCFL transformers are designed to work with inexpensive Royer class self-oscillating circuits. The Royer circuit works with input voltage from 2.5 to 20Vdc and is capable of producing 90% efficiency above 5Vdc input.

Royer Diagram

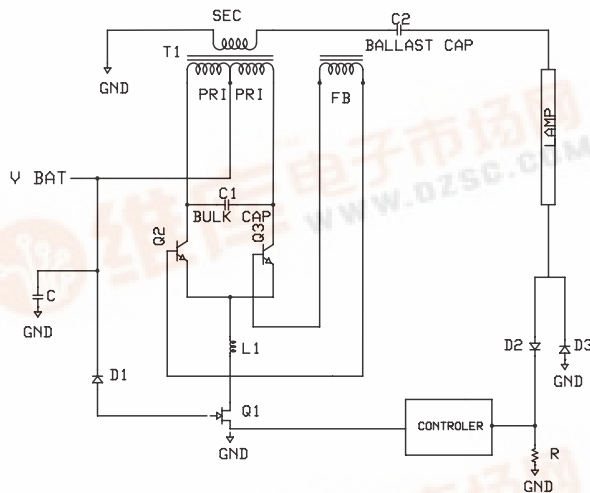

A current-fed, push-pull topology is commonly used to power the CCFL transformer. This topology accommodates a wide input voltage and consists of a resonant push-pull stage, a Pulse-Width-Modulated (PWM) buck-derived control stage and a high-voltage secondary stage. The push-pull stage consists of transistors Q2 and Q3 to drive the center-tapped transformer T1. The transistors are driven 180° out of phase at 50% duty cycle with an auxiliary winding on the transformer. A resonant tank is formed between the primary inductance of the transformer and a low-loss, external resonant bulk capacitor C1. The resonant tank provides a sinusoidal voltage to the transformer's primary winding and sets the system's operating frequency.

The high voltage at the secondary of transformer is used to ignite and operate the lamp. Since the ignition or "strike voltage" is higher than the operating voltage, a high voltage ballast capacitor C2 is required to allow a voltage difference between the transformer secondary and the lamp. To minimize lamp stress and improve efficiency, the striking voltage waveforms should be sinusoidal.

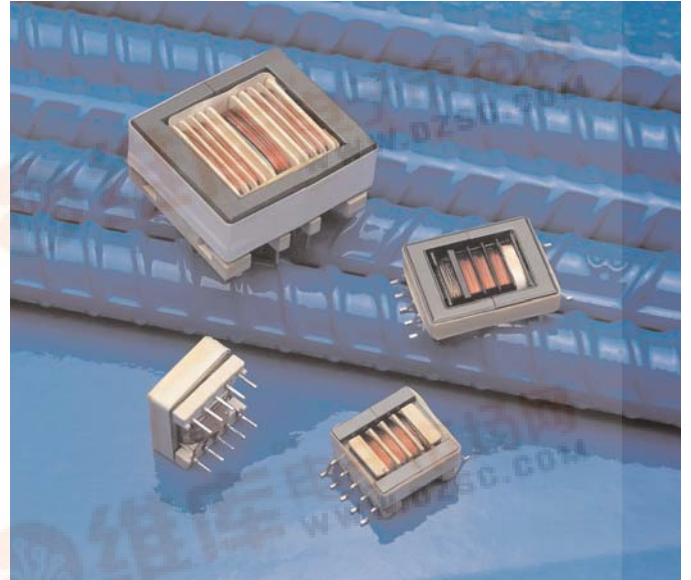

Transformer Selection

The CCFL lamp manufacturer supplies the following lamp characteristics:

1. Strike voltage (V_{strike})
2. Running voltage (V_{run})
3. Frequency of operation (F_{res})
4. Power (W)
5. Current (I_{lamp})

The first step is to select the transformer according to the power requirement from the catalog.

The second step is to decide the termination.

Use this formula to find the turn ratio needed to obtain the strike voltage of the lamp.

$$V_{strike} = \frac{\pi \times V_{in\ min}}{\sqrt{2}} \times TR$$

TR = Turns ratio

$V_{in\ min}$ = Battery voltage

The operating frequency of the system is determined by the inductance of the primary and the bulk capacitor across the primary at resonance.

$$F_{Res} = \frac{1}{2 \times \pi \sqrt{L_{Pri} \times C_{Bulk}}}$$

F_{res} = Resonance Frequency

Determine the ballast capacitor value using the equation below.

$$C_{ballast} = \frac{I_{lamp}}{2 \times \pi \times F_{res} \sqrt{(V_{run}^2 - V_{sec}^2)}}$$

V_{sec} = Transformer secondary voltage

V_{run} = Lamp running voltage

I_{lamp} = Lamp current

F_{res} = Resonance frequency

C_{ballast} = Ballast capacitor

The capacitor voltage is 90 degrees out of phase with the lamp running voltage.

From this equation, determine the value of the ballast capacitor.

Schematic Relation to Part Number

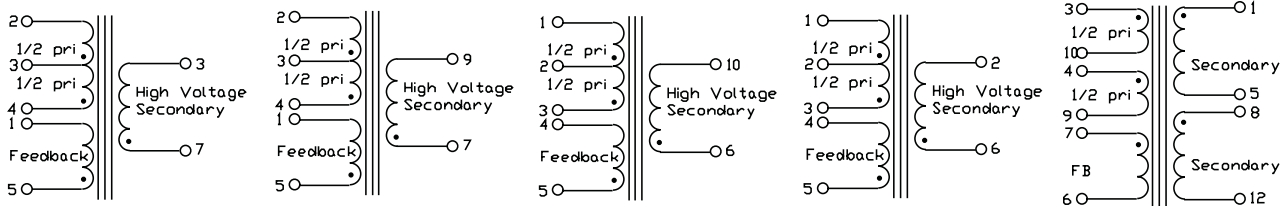

Schematic A	Schematic B	Schematic C		Schematic D	Schematic E
CTX110652-R	CTX110655-R	CTX210403-R	CTX110603-R	CTX110600-R	CTX410805-R
CTX210652-R	CTX110657-R	CTX210407-R	CTX110605-R	CTX210600-R	CTX410807-R
	CTX110659-R	CTX210409-R	CTX110607-R		CTX410809-R
	CTX210655-R	CTX210411-R	CTX110609-R		
	CTX210657-R	CTX310403-R	CTX110611-R		
	CTX210659-R	CTX310405-R	CTX210603-R		
		CTX310407-R	CTX210605-R		
		CTX310409-R	CTX210607-R		
		CTX310411-R	CTX210609-R		
			CTX210611-R		

Coiltronics® Transformer Features:

1. Supply high voltage.
2. Operation frequency range from 40 to 80kHz.
3. Deliver output power from 2.5 to 14 watts.
4. Slim or low profile type easily built into your design.
5. Available in through-hole and SMT recess or gull wing type.
6. Operate in Royer and direct IC drive.
7. 1500 volt primary to secondary isolation.
8. Ferrite core material.
9. Designed for floating and non-floating applications.
10. Transformer secondary is machine wound on sections to increase leakage inductance and reduce voltage gradient between layers.

Layout and Circuit Considerations

- The high voltage traces must be separated from low voltage traces.
- The ballast capacitor must be placed closer to the transformer secondary pin.
- Avoid long wire connections from the transformer to the lamp. Stray capacitance between wire and ground will reduce efficiency.
- Incorporate open lamp and overload protection in the circuit design. Open lamp will cause full voltage in the transformer output and will burn the transformer. Most of the CCFL IC has protection built in the circuit for open and overload condition.

Part Number	Power Watts	TR1 Ns/Np	TR2 Np/FB	L _{pri} μH	V _{pri} Volts	I _{sec} mA max	DCR _{pri} Ω max	DCR _{sec} Ω max	Schematic Reference	Mechanical Reference
CTX110652-R	2.5	67	6	43	20	5	0.220	285	A	A
CTX110655-R	2.5	67	6	43	20	5	0.220	285	B	A
CTX110657-R	2.5	86	2	26	15	5	0.212	285	B	A
CTX110659-R	2.5	100	4	19	13	5	0.190	285	B	A
CTX210652-R	2.5	67	6	43	20	5	0.220	285	A	C
CTX210655-R	2.5	67	6	43	20	5	0.220	285	B	C
CTX210657-R	2.5	86	2	26	15	5	0.212	285	B	C
CTX210659-R	2.5	100	4	19	13	5	0.190	285	B	C
CTX210403-R	4.00	50	6	44	26	7	0.220	165	C	B
CTX210407-R	4.00	86	4.7	27	15	7	0.160	220	C	B
CTX210409-R	4.00	100	4	20	13	7	0.160	220	C	B
CTX210411-R	4.00	125	4	20	10	7	0.160	330	C	B
CTX310403-R	4.00	50	6	44	26	7	0.220	165	C	D
CTX310407-R	4.00	86	4.7	27	15	7	0.160	220	C	D
CTX310409-R	4.00	100	4	20	13	7	0.160	220	C	D
CTX310411-R	4.00	125	4	20	10	7	0.160	330	C	D
CTX110600-R	6.00	67	6	44	20	12	0.160	176	D	E
CTX110603-R	6.00	50	6	44	26	12	0.160	132	C	E
CTX110605-R	6.00	67	6	44	20	12	0.160	176	C	E
CTX110607-R	6.00	86	4.7	27	15	12	0.132	176	C	E
CTX110609-R	6.00	100	6	20	13	12	0.132	176	C	E
CTX110611-R	6.00	125	4	20	13	12	0.132	291	C	E
CTX210600-R	6.00	67	6	44	20	12	0.160	176	D	F
CTX210603-R	6.00	50	6	44	26	12	0.160	132	C	F
CTX210605-R	6.00	67	6	44	20	12	0.160	176	C	F
CTX210607-R	6.00	86	4.7	27	15	12	0.132	176	C	F
CTX210609-R	6.00	100	6	20	13	12	0.132	176	C	F
CTX210611-R	6.00	125	4	20	13	12	0.132	291	C	F
CTX410805-R	14.00	67	5	24	30	30	0.030	262	F	G
CTX410807-R	14.00	86	4	16	23	30	0.024	272	F	G
CTX410809-R	14.00	100	4	16	23	30	0.024	314	F	G

Full primary turns used in turns ratio calculation.

Ns/Np= Turns Secondary/Turns Primary.

Np/FB= Turns Primary/FeedBack Winding.

Mechanical References

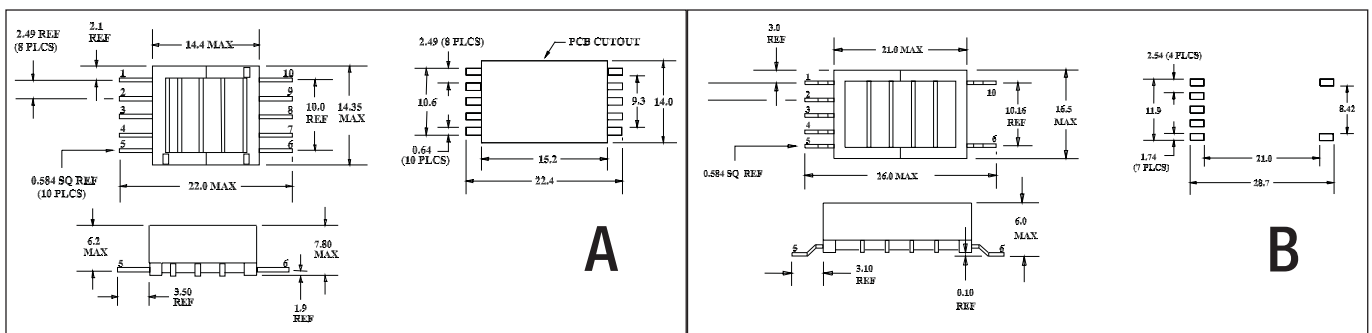

Mechanical References

[查询"CTX210603-R"供应商](#)

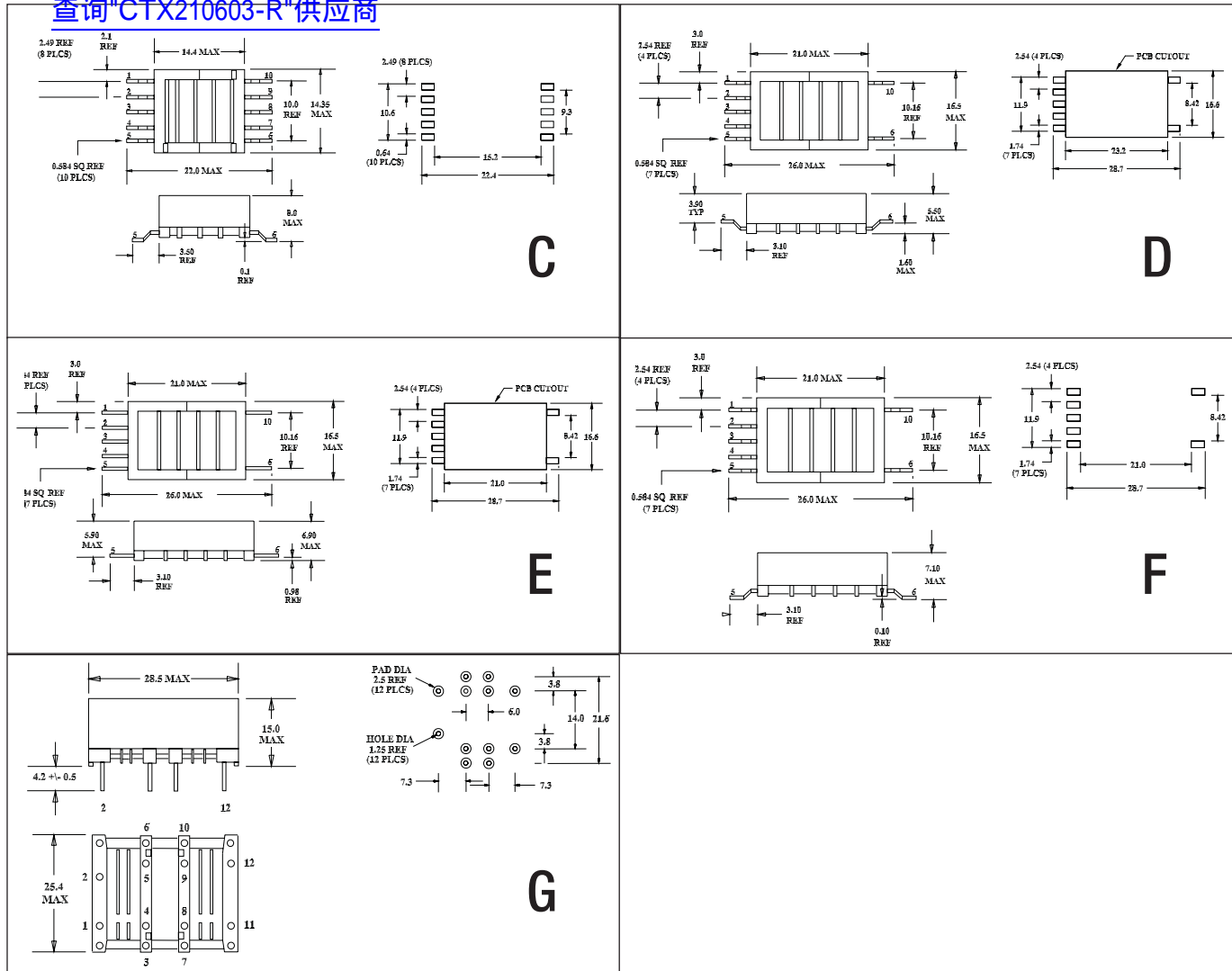

The Cooper Bussmann® Coiltronics® brand of magnetics specializes in standard and custom solutions, offering the latest in state-of-the-art low-profile high power density magnetic components. We remain at the forefront of innovation and new technology to deliver the optimal mix of packaging, high efficiency and unbeatable reliability. Our designs utilize high frequency, low core loss materials, and new and custom core shapes in combination with innovative construction and packaging to provide designers with the highest performance parts available on the market. The Coiltronics Brand product line of power magnetics continually expands to satisfy shifts in technology and related market needs. Standard Product Categories include:

- Shielded Drum Inductors
- Unshielded Drum Inductors
- High Current Inductors
- Toroidal Inductors
- Specialty Magnetics
- Custom Magnetics

Please visit <http://www.cooperbussmann.com/datasheets/elx> to see the wide variety of inductor solutions we have to offer.

Order samples online - www.cooperbussmann.com

© 2008 Cooper Bussmann
St. Louis, MO 63178
636-394-2877
www.cooperbussmann.com

