

[查询"MPC9140"供应商](#)
Product Preview

1:18 LVCMOS Fanout Buffer

The MPC9140 is a 1:18 LVCMOS fanout buffer targeted to support Intel based Pentium II™ microprocessor chip sets. The device features 18 low skew outputs optimized to drive the clock inputs of standard unbuffered SDRAM modules. Standard unbuffered SDRAM modules require four clocks per module allowing for the device to drive up to four modules. The output buffers have been optimized to drive the load presented by the SDRAM module.

The MPC9140 provides output shut off capabilities via an I²C serial port for applications which plan to use fewer than four modules and desire to minimize the power dissipation of the chip. Every output clock can be individually enabled/disabled through fields in the I²C control registers. After power up the default state is all outputs enabled. In applications where this default state is acceptable the I²C ports need not be exercised.

- Supports Intel Pentium™ and Pentium II Processor Architectures
- 18 Skew Controlled 3.3V Compatible SDRAM Clocks
- I²C Serial Bus Interface
- Extensive Output Enable Control Capability
- Space Efficient 48-Lead SSOP Package
- Operating Temperature Range of 0°C to 70°C
- 3.3V ± 5% Power Supply

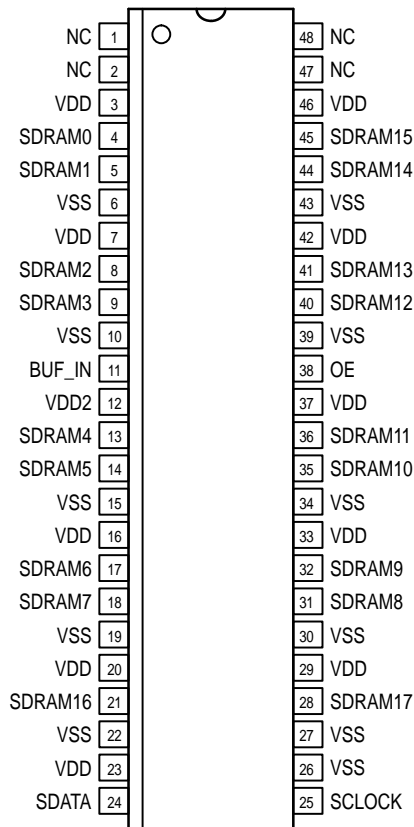
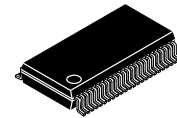

Figure 1. 48-Lead Pinout (Top View)

MPC9140

**1:18 LVCMOS
FANOUT BUFFER**



SD SUFFIX
48-LEAD PLASTIC SSOP PACKAGE
CASE 1215-01

FUNCTION TABLE

OE	V1, V2
0	High-Z
1	1x BUF_IN

This document contains information on a product under development. Motorola reserves the right to change or discontinue this product without notice.



[查询"MPC9140"供应商](#)

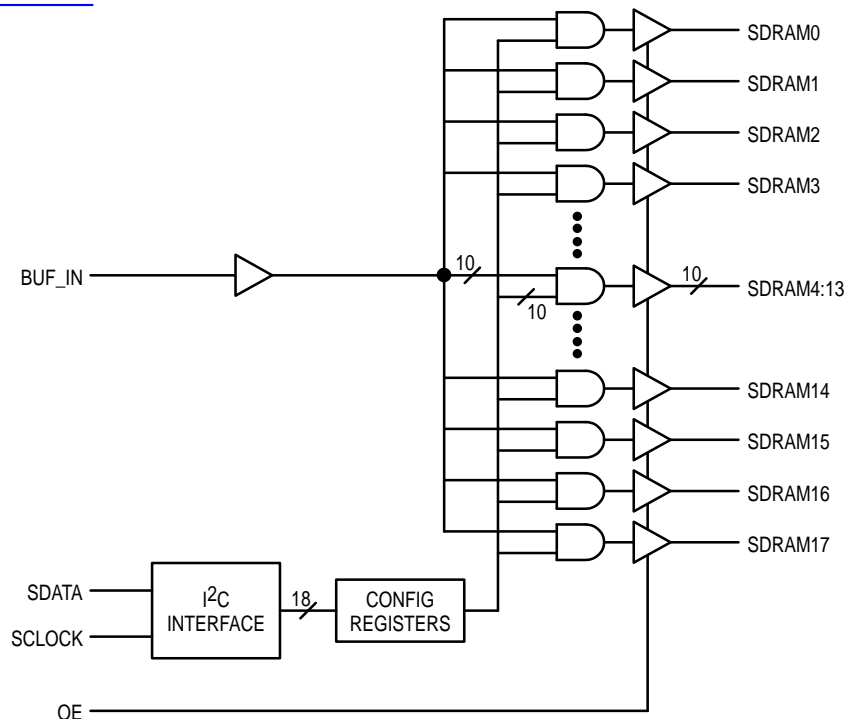

Figure 2. Block Diagram

Table 1. Pin Descriptions

Pin Name	I/O	Function
BUF_IN	I	3.3V CMOS clock input
SDRAM0:17	O	3.3V CMOS SDRAM clock outputs
SDATA	I/O	Serial data for configuration control
SCLK	I	Serial clock input for configuration control. The state of the SDATA input is clocked into the device on the rising edge of this clock
OE	I	A Low forces all outputs into High-Z state
VDD	-	3.3V power supply connection
VSS	-	Ground connection which should be connected directly to the ground plane

查询"MPC9140"供应商

I²C Interface

The device has an I²C serial bus interface consisting of a serial clock input (SCLK) and a data line (SDATA). The clock driver acts as a slave receiver on the I²C bus with a standard data transfer rate of up to 100 kbit/s. The MPC9140 is a 'write only' device which will not respond to general call requests from the bus master. The I²C interface transfers data in byte length packets except for the start, stop and acknowledge bits. The clock driver supports block writes consisting of the following elements.

- 1) Start Bit
- 2) Address
- 3) Acknowledge Bit
- 4) Command Code
- 5) Acknowledge Bit
- 6) Byte Count
- 7) Acknowledge Bit
- 8) Data Fields (see Table 2)
- 9) Acknowledge Bit
- 10) Stop Bit

After each byte, the clock driver pulls down the data line to acknowledge the transfer. The clock driver holds SDATA low during the high state of SCLK. The 7-bit address of the clock driver is:

A7	A6	A5	A4	A3	A2	A1	R/W
1	1	0	1	0	0	1	0

Note: A7 is the first address bit

The 'Command Code' should be set to all '0's and the 'Byte Count' can range from 1 to 3. The data fields are transferred sequentially in ascending order starting with Byte 0 – Configuration Function.

The MPC9140 is compliant with the DC/AC characteristics of a "Standard-Mode" I²C bus device. The logic thresholds are dependent on the 3.3V supply. For additional information on the I²C bus, refer to the document, 3114 – "The I²C-bus and how to use it (including specifications)" available from Philips Semiconductors:

<http://www.semiconductors.philips.com>

Table 2. Serial Data Fields

Byte	Function	Bit 7	Bit 6	Bit 5	Bit 4	Bit 3	Bit 2	Bit 1	Bit 0
0	SDRAM0:7	SDRAM7	SDRAM6	SDRAM5	SDRAM4	SDRAM3	SDRAM2	SDRAM1	SDRAM0
	Package Pin	18	17	14	13	9	8	5	4
1	SDRAM8:15	SDRAM15	SDRAM14	SDRAM13	SDRAM12	SDRAM11	SDRAM10	SDRAM9	SDRAM8
	Package Pin	45	44	41	40	36	35	32	31
2	SDRAM16:17	SDRAM17	SDRAM16	N/A	N/A	N/A	N/A	N/A	N/A
	Package Pin	28	21						

1. Not Applicable (N/A) bits fields are "Don't Care" conditions.

2. When a bit field is programmed with a "1" (enable), the clock is active. A "0" (disable) means the clock is inactive.

MAXIMUM RATINGS*

Symbol	Parameter	Min	Max	Unit
VDD	3.3V Core Supply Voltage	-0.5	4.6	V
T _{stg}	Storage Temperature Range	-65	150	°C
V _{IH}	3.3V Input High Voltage (Note 3.)	-0.5	4.6	V
V _{IL}	3.3V Input Low Voltage	-0.5		V
ESD	ESD Input Protection	2000		V

* Maximum Ratings are those values beyond which damage to the device may occur. Functional operation should be restricted to the Recommended Operating Conditions.

3. V_{IH} should not exceed VDD level.

MPC9140

[查询"MPC9140"供应商](#)

DC CHARACTERISTICS (VDD = 3.3V ±5%; GND = 0.0V; TA = 0 to +70°C; Unless Otherwise Specified)

Symbol	Characteristic	Min	Typ	Max	Unit	Condition
I _{DD}	Supply Current for VDD		TBD		mA	
V _{IL}	Input Low Voltage	-0.3		0.8	V	
V _{IH}	Input High Voltage	2.0		VDD+0.3	V	
I _{IL}	Input Leakage Current	-5.0		5	μA	0 < V _{IN} < VCC/VCCI
V _{OL}	3.3V Output Low Voltage			0.40	V	I _{OL} = 1mA
V _{OH}	3.3V Output High Voltage	2.4			V	I _{OH} = -1.0mA
C _I	Input Capacitance		TBD		pF	Except XTL_In, XTL_Out
L _I	Input Inductance		TBD		nH	Except XTL_In, XTL_Out

AC CHARACTERISTICS (VDD = 3.3V ±5%; GND = 0.0V; TA = 0 to +70°C; Unless Otherwise Specified)

Symbol	Characteristic	Min	Typ	Max	Unit	Condition
--------	----------------	-----	-----	-----	------	-----------

SDRAM Clock Outputs (SDRAM0:17)

t _{sk}	Output Clock Skew			250	ps	Note 4.
d _t	Output Duty Cycle	45		55	%	Note 5.
t _p	Clock Period	66MHz 100MHz	15.0 10.0	15.5 10.5	ns	Note 4.
t _{VIH}	High Time	66MHz 100MHz	5.6 3.3		ns	Measured at 2.4V
t _{VIL}	Low Time	66MHz 100MHz	5.3 3.1		ns	Measured at 0.4V
t _{rise}	Rise Time		1.5	4.0	V/ns	From 0.4V to 2.4V
t _{fall}	Fall Time		1.5	4.0	V/ns	From 2.4V to 0.4V
t _{PLH}	Low to High Propagation Delay		1.0	5.0	ns	
t _{PHL}	High to Low Propagation Delay		1.0	5.0	ns	
t _{PZL} , t _{PZH}	Enable Delay		1.0	8.0	ns	
t _{PLZ} , t _{PHZ}	Disable Delay		1.0	8.0	ns	

4. Measured on the rising edge of the clock at 1.5V.

5. Input slew rate >1V/ns.

APPLICATIONS INFORMATION

Output Series Termination

With typical MPC9140 edge rates of 1.5V/ns, a PCB trace becomes a transmission line when it is over 1-inch in length. This transmission line needs some sort of termination scheme to ensure good signal integrity at the load (device receiving clock signal). Most motherboards use the practice of *series termination*. In series termination, a series termination resistor (external resistor) is added in series with the driver device output, as shown in Figure 3, series termination resistor value is chosen so that its value, added to the output impedance of the driver, is equal to the PCB trace impedance, or in other words, $R_{TH} = R_S + Z_L$. The series termination resistor must be located close to the device output.

Typical system PCB trace impedance is 50–70Ω, which is low enough to produce sufficient signal rise and fall time at the load capacitance presented by a standard CMOS input. Figure 4 illustrates proper series termination of the 15Ω MPC9140 output driving a 60Ω transmission line.

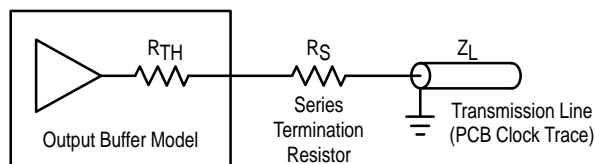

Figure 3. Clock Output Series Termination

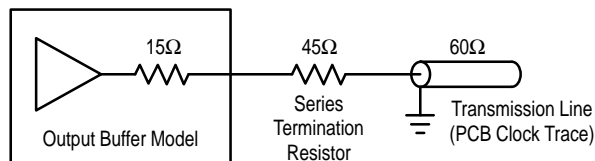

Figure 4. Clock Output Series Termination

Pull-Up			
Voltage (V)	I _{min} (mA)	I _{typ} (mA)	I _{max} (mA)
0	-72	-116	-198
1.000	-72	-116	-198
1.400	-68	-110	-188
1.500	-67	-107	-184
1.650	-64	-103	-177
1.800	-60	-98	-170
2.000	-54	-90	-157
2.400	-39	-69	-126
2.600	-30	-56	-107
3.135	0	-15	-46
3.300	-	0	-23
3.465	-	-	0

Pull-Down			
Voltage (V)	I _{min} (mA)	I _{typ} (mA)	I _{max} (mA)
0	0	0	0
0.400	23	34	53
0.650	35	52	83
0.850	43	65	104
1.000	49	74	118
1.400	61	93	152
1.500	64	98	159
1.650	67	103	168
1.800	70	108	177
1.950	72	112	184
3.315	72	112	204
3.600	-	112	204

Figure 5. Typical Output V/I Characteristics for MPC9140

[查询"MPC9140"供应商](#)

OUTLINE DIMENSIONS

**SD SUFFIX
PLASTIC SSOP PACKAGE
CASE 1215-01
ISSUE 0**

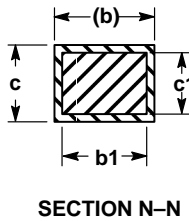
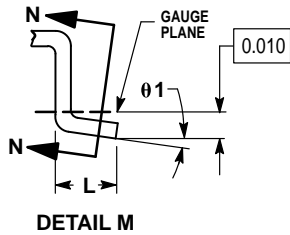
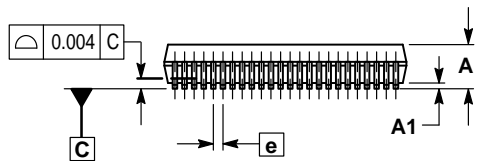
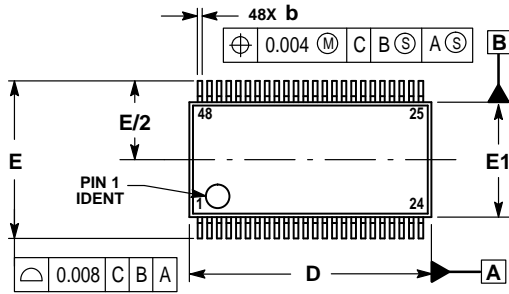

NOTES:

1. DIMENSIONS ARE IN INCH.
2. INTERPRET DIMENSIONS AND TOLERANCES PER ASME Y14.5M, 1994.
3. DIMENSION D DOES NOT INCLUDE MOLD FLASH, PROTRUSIONS OR GATE BURRS. MOLD FLASH OR GATE BURRS SHALL NOT EXCEED 0.006 PER SIDE.
4. DIMENSION E1 DOES NOT INCLUDE INTERLEAD FLASH OR PROTRUSION. INTERLEAD FLASH OR PROTRUSION SHALL NOT EXCEED 0.010 PER SIDE.
5. DIMENSION b DOES NOT INCLUDE DAMBAR PROTRUSION/INTRUSION. ALLOWABLE DAMBAR PROTRUSIONS SHALL BE 0.003 TOTAL IN EXCESS OF b DIMENSION AT MAXIMUM MATERIAL CONDITION. DAMBAR INTRUSION SHALL NOT REDUCE DIMENSION b BY MORE THAN 0.003 AT LEAST MATERIAL CONDITION.
6. TERMINAL NUMBERS ARE SHOWN FOR REFERENCE ONLY.
7. DIMENSION D AND E1 ARE TO BE DETERMINED AT DATUM PLANE H.

DIM	INCHES	
	MIN	MAX
A	0.095	0.110
A1	0.008	0.016
D	0.620	0.630
E	0.400	0.410
E1	0.292	0.299
L	0.024	0.040
b	0.008	0.0135
b1	0.008	0.012
c	0.005	0.010
c1	0.005	0.0085
e	0.025 BSC	
θ1	0°	8°

Pentium and Pentium II are trademarks of Intel Corp.

Motorola reserves the right to make changes without further notice to any products herein. Motorola makes no warranty, representation or guarantee regarding the suitability of its products for any particular purpose, nor does Motorola assume any liability arising out of the application or use of any product or circuit, and specifically disclaims any and all liability, including without limitation consequential or incidental damages. "Typical" parameters which may be provided in Motorola data sheets and/or specifications can and do vary in different applications and actual performance may vary over time. All operating parameters, including "Typicals" must be validated for each customer application by customer's technical experts. Motorola does not convey any license under its patent rights nor the rights of others. Motorola products are not designed, intended, or authorized for use as components in systems intended for surgical implant into the body, or other applications intended to support or sustain life, or for any other application in which the failure of the Motorola product could create a situation where personal injury or death may occur. Should Buyer purchase or use Motorola products for any such unintended or unauthorized application, Buyer shall indemnify and hold Motorola and its officers, employees, subsidiaries, affiliates, and distributors harmless against all claims, costs, damages, and expenses, and reasonable attorney fees arising out of, directly or indirectly, any claim of personal injury or death associated with such unintended or unauthorized use, even if such claim alleges that Motorola was negligent regarding the design or manufacture of the part. Motorola and are registered trademarks of Motorola, Inc. Motorola, Inc. is an Equal Opportunity/Affirmative Action Employer.

Mfax is a trademark of Motorola, Inc.

How to reach us:

USA/EUROPE/Locations Not Listed: Motorola Literature Distribution; P.O. Box 5405, Denver, Colorado 80217. 303-675-2140 or 1-800-441-2447

JAPAN: Nippon Motorola Ltd.: SPD, Strategic Planning Office, 4-32-1, Nishi-Gotanda, Shinagawa-ku, Tokyo 141, Japan. 81-3-5487-8488

Mfax™: RMFAX0@email.sps.mot.com – TOUCHTONE 602-244-6609
– US & Canada ONLY 1-800-774-1848

ASIA/PACIFIC: Motorola Semiconductors H.K. Ltd.; 8B Tai Ping Industrial Park, 51 Ting Kok Road, Tai Po, N.T., Hong Kong. 852-26629298

INTERNET: <http://motorola.com/sps>

