

# PRODUCT SPECIFICATION

**Model No : CST-432/431T9**

## Descriptions:

- 0.4 Inch Triad Digits Display
- CST-432: Common Anode
- CST-431: Common Cathode
- Emitting Color: Super Bright Yellow



CUSTOMER APPROVED SIGNATURES	APPROVED BY	CHECKED BY	PREPARED BY

**CHINA SEMICONDUCTOR CORPORATION**

Address:2FL. NO.909,Chung-Cheng Road,  
Chung-Ho City Taipei Hsien,Taiwan.

Tel:886-2-2223-9696  
Fax:886-2-2223-9377

**OPTO PLUS TECHNOLOGIES CO.,LTD**

Address:696 Shun jiang Rd.,Ji Shan St.Shaoxing,  
ZheJiang,China

Tel:86-0575-88623888  
Fax:86-0575-88623112

<http://www.csctw.com.tw>



**Model No : CST-432/431T9**

**Features -**

1. 0.4 inch (10.2mm) digit height.
2. Case mold type.
3. RoHS compliant.
4. Low power consumption.
5. Easy mounting on P.C. board or socket.

**Device Selection Guide -**

Part No.	Chip		Description
	Material	Emitted Color	
CST-432T9	AlGaInP	Super Bright Yellow	Common Anode
CST-431T9	AlGaInP	Super Bright Yellow	Common Cathode

**Package Dimensions -**

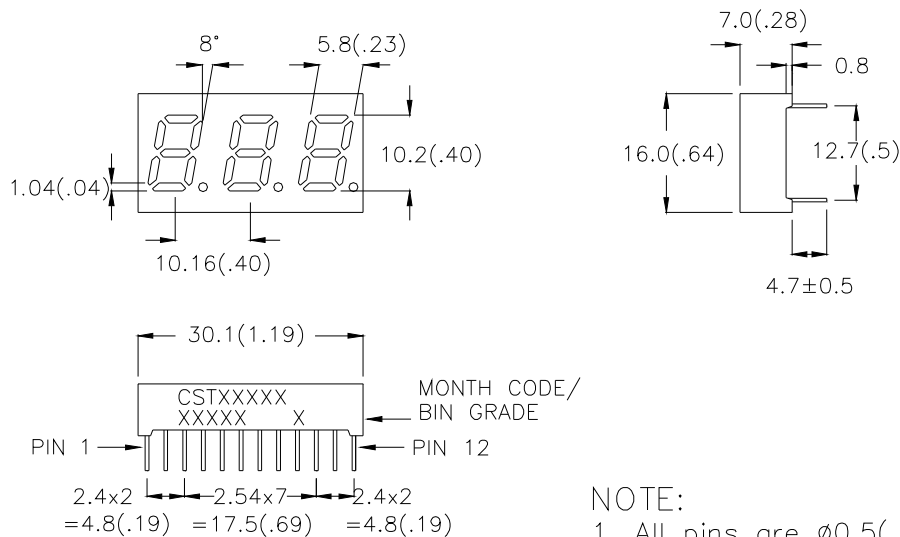

**NOTE:**

1. All pins are  $\phi 0.5(.02)$ .
2. Dimension in millimeter (inch), and tolerance is  $\pm 0.25 (.01)$  unless otherwise noted.

Model No : CST-432/431T9

Internal Circuit Diagrams -

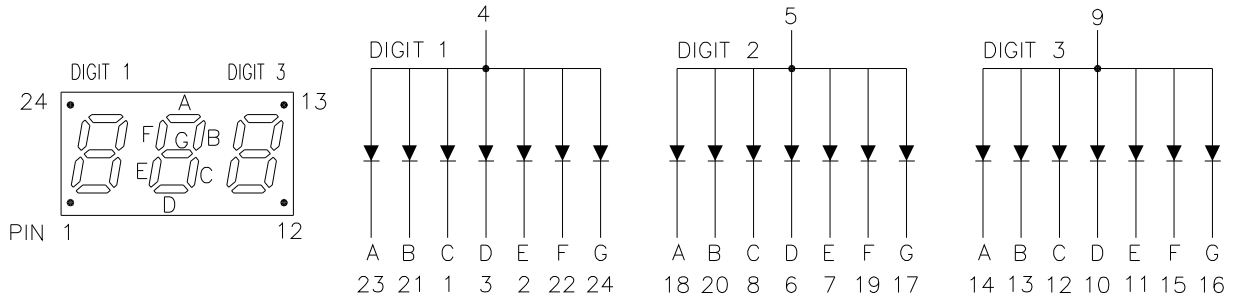

CST-432 Common Anode  
 (CST-431 Common Cathode)

Absolute Maximum Rating -

(Ta=25°C)

Parameter	Symbol	Rating	Unit
Power Dissipation Per Dice	<b>P<sub>AD</sub></b>	70	mW
Continuous Forward Current Per Dice	<b>I<sub>AF</sub></b>	25	mA
Peak Current Per Dice(duty cycle 1/10,1KHz)	<b>I<sub>PF</sub></b>	90	mA
Derating Linear From 25°C Per Dice	-	0.33	mA/°C
Reverse Voltage Per Dice	<b>V<sub>R</sub></b>	5	V
Operating Temp.	<b>T<sub>opr</sub></b>	-35 ~ +85	°C
Storage Temp.	<b>T<sub>stg</sub></b>	-35 ~ +85	°C
Solder temperature 1/16 inch below seating plane for 3 seconds at 260°C			

**Model No : CST-432/431T9**

**■ Electro-optical Characteristics -**

(Ta=25°C)

Parameter	Symbol	Min.	Typ.	Max.	Unit	Condition
Forward Voltage Per Segment	V <sub>F</sub>	-	2.1	2.8	V	I <sub>F</sub> =20mA
Luminous Intensity Per Segment	I <sub>v</sub>	-	14	-	mcd	I <sub>F</sub> =10mA
Peak Emission Wavelength	λ <sub>p</sub>	-	592	-	nm	I <sub>F</sub> =20mA
Dominant Wavelength	λ <sub>d</sub>	-	590	-	nm	I <sub>F</sub> =20mA
Spectrum Radiation Bandwidth	Δλ	-	20	-	nm	I <sub>F</sub> =20mA
Reverse Current	I <sub>R</sub>	-	-	100	μA	V <sub>R</sub> =5V
Luminous Intensity Matching Ratio	I <sub>V-m</sub>	-	-	2:1	-	I <sub>F</sub> =10mA

**Model No : CST-432/431T9**

**Typical Electrical / Optical Charateristics Curves -**

(Ta = 25°C Unless Otherwise Noted)

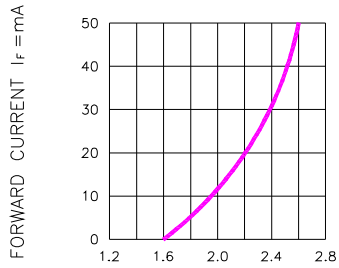

Fig.1 FORWARD CURRENT VS. FORWARD VOLTAGE

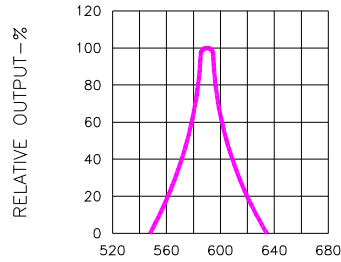

Fig.2 SPECTRAL RESPONSE

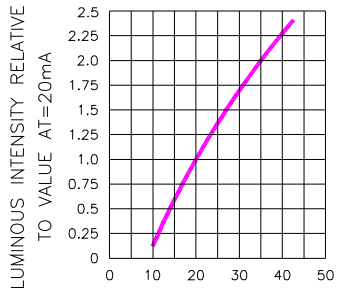

Fig.3 RELATIVE LUMINOUS INTENSITY VS. FORWARD CURRENT

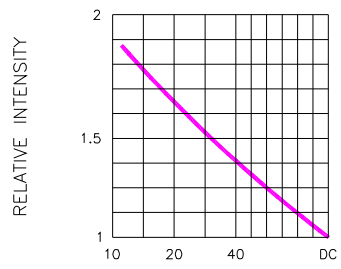

Fig.5 LUMINOUS INTENSITY VS. DUTY CYCLE

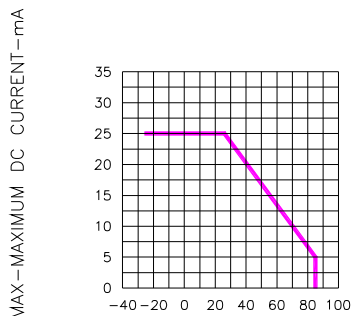

Fig.4 MAXIMUM ALLOWABLE DC CURRENT PER SEGMENT VS. A FUNCTION OF AMBIENT TEMPERATURE

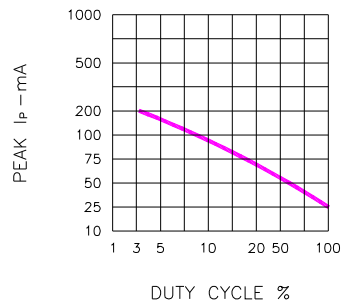
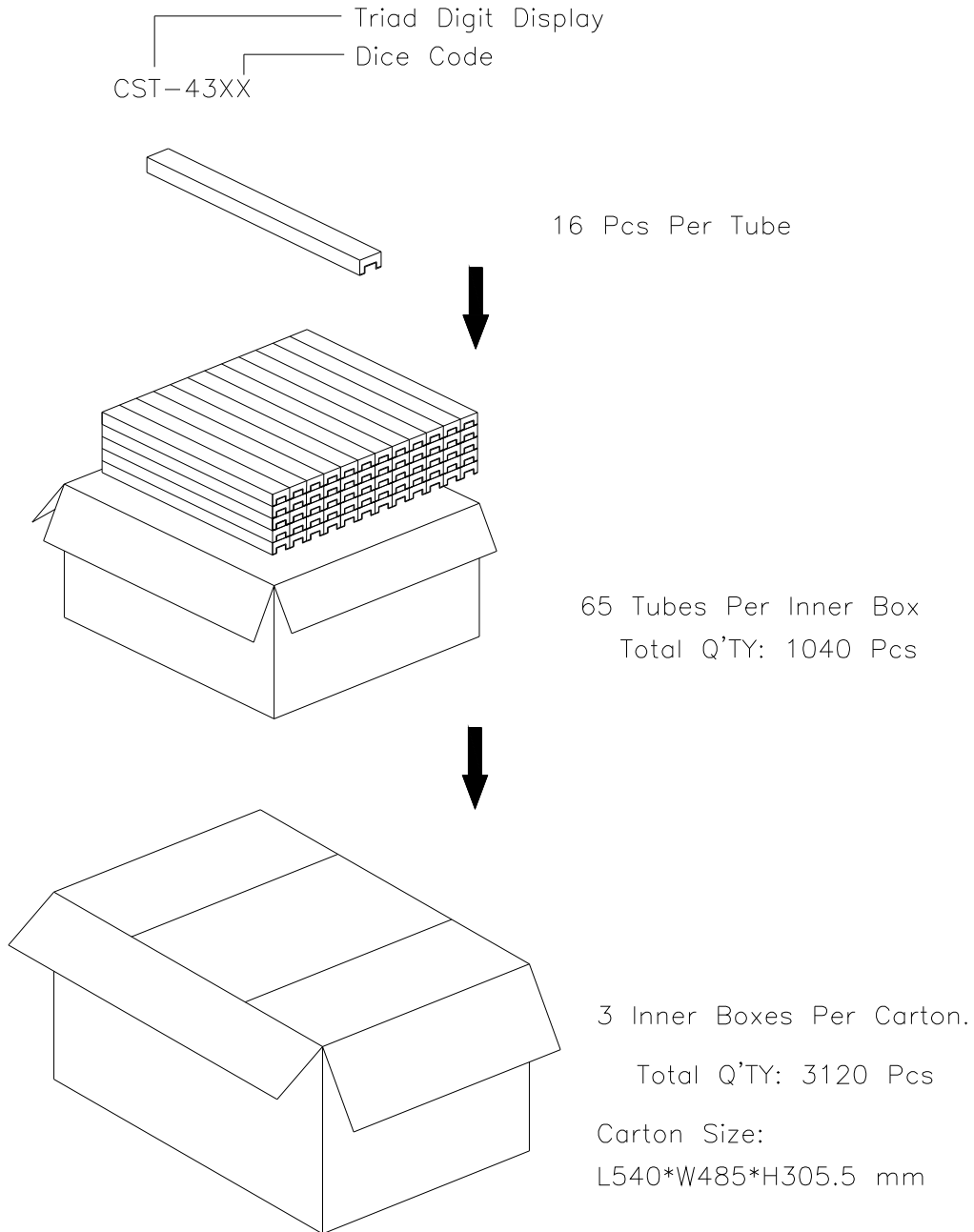

Fig.6 MAX PEAK CURRENT VS. DUTY CYCLE % (REFRESH RATE f=1 KHz)

Model No: CST-432/431T9

■ Package Dimensions



Note: The specifications are subject to change without notice. Please contact us for updated information.