

Model 72991
SMB JACK R/A CRIMP, RG178, 196

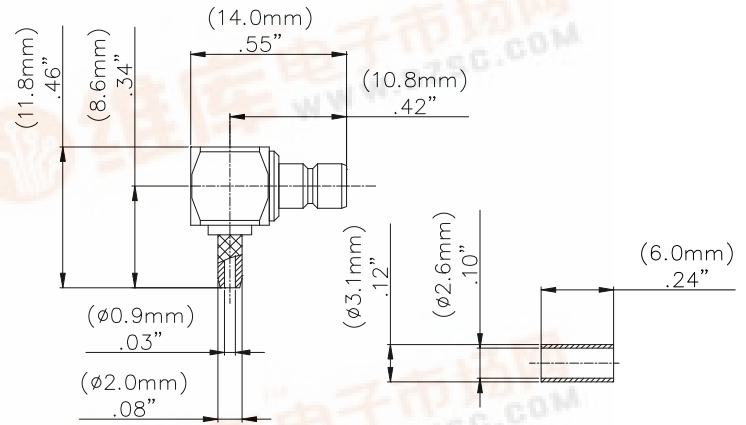

Model 72991 SMB JACK R/A CRIMP, RG178, 196

Snap-on coupling and small size for fast connect and disconnect.

Features

- DC - 3 GHz bandwidth.
- Meets MIL-C-39012, IEC 60169-1Q, BS9210N0007, NFC93650, CECC 22130.
- Small size and durability for RF coaxial applications.
- Precision machined and gold-plated for low loss.

Materials

- Body is machined brass with gold plating.
- Center contacts – Plug is gold plated brass and Jack is gold plated beryllium copper.
- High quality PTFE insulators.
- Crimp Ferrules are nickel plated copper.
- Silicone rubber gaskets.

Specifications

Impedance	50 Ω
Frequency Range	DC - 3 GHz
VSWR	1.4 max.
Working Voltage	250 Vrms max.
Dielectric withstand voltage	750 Vrms
Center / Outer contact resistance	6 / 1 mΩ
Number of insertions	500 cycles min.
Insulation resistance	1,000 MΩ min.
Temperature Range	-65° C to 165° C, -85° F to 329° F

Ordering Information

Model: 72991
Description: SMB JACK R/A CRIMP, RG178, 196

USA: Sales: 800-490-2361
Technical Support: technicalsupport@pomonaest.com
Fax: 425-446-5844

Europe: 31-(0) 40 2675 150 International: 425-446-5500

Where to Buy: www.pomonaelectronics.com

All dimensions are in inches. Tolerances (except noted): .xx = ±.02" (.51 mm), .xxx = ±.005" (.127 mm). All specifications are to the latest revisions. Specifications are subject to change without notice. Registered trademarks are the property of their respective companies.
D2003429 REV 001

Model 72991
SMB JACK R/A CRIMP, RG178, 196

Cable Types and Crimp Die Information

Connector Model #	Cable Groups	Crimp Die Cavity Size for Outer Ferrule
72991	RG178, 196	.105 (2.67)

Cable Assembly Instructions

1. CUT CABLE END EVENLY AND PERPENDICULAR

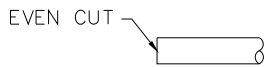

2. SLIDE OUTER FERRULE OVER CABLE END.

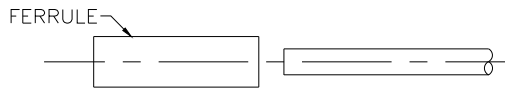

3. STRIP CABLE JACKET, BRAID, AND DIELECTRIC TO SPECIFICATION LENGTHS.

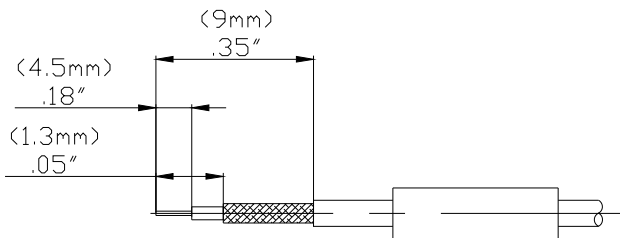

RECOMMENDED STRIP LENGTHS

4. FLARE BRAID END SLIGHTLY.

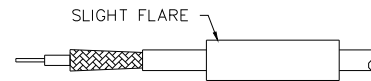

5. SLIDE CONNECTOR BODY OVER CENTER CONDUCTOR.

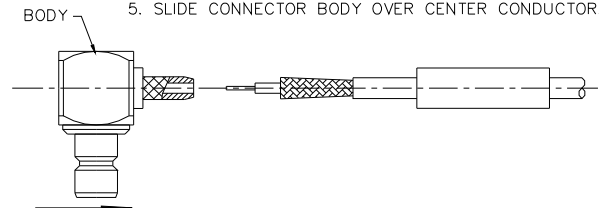

6. SLIDE OUTER FERRULE OVER BRAID AND UP AGAINST BODY ASSEMBLY.

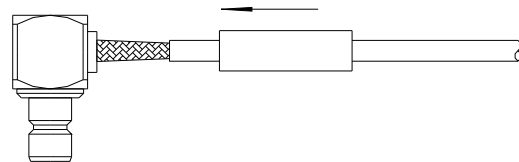

7. CRIMP OUTER FERRULE WITH APPROPRIATE CRIMP TOOL.

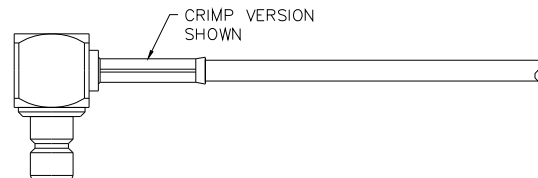

USA: Sales: 800-490-2361
 Technical Support: technicalsupport@pomonatest.com
 Fax: 425-446-5844
Europe: 31-(0) 40 2675 150 **International:** 425-446-5500
Where to Buy: www.pomonaelectronics.com

All dimensions are in inches. Tolerances (except noted): .xx = ±.02" (.51 mm), .xxx = ±.005" (.127 mm). All specifications are to the latest revisions. Specifications are subject to change without notice. Registered trademarks are the property of their respective companies.
 D2003429 REV 001