



# Power MOSFET

## 40 V, 69 A, Single N-Channel, DPAK/IPAK

### Features

- Low  $R_{DS(on)}$
- High Current Capability
- Avalanche Energy Specified
- These are Pb-Free Devices

### Applications

- CCFL Backlight
- DC Motor Control
- Class D Amplifier
- Power Supply Secondary Side Synchronous Rectification

### MAXIMUM RATINGS ( $T_J = 25^\circ\text{C}$ unless otherwise noted)

Parameter	Symbol	Value	Unit	
Drain-to-Source Voltage	$V_{DSS}$	40	V	
Gate-to-Source Voltage – Continuous	$V_{GS}$	$\pm 20$	V	
Gate-to-Source Voltage – Non-Repetitive ( $t_p < 10 \mu\text{s}$ )	$V_{GS}$	$\pm 30$	V	
Continuous Drain Current ( $R_{\theta JC}$ ) (Note 1)	Steady State	$T_C = 25^\circ\text{C}$	$I_D$ 69	A
		$T_C = 100^\circ\text{C}$	49	
Power Dissipation ( $R_{\theta JC}$ ) (Note 1)		$T_C = 25^\circ\text{C}$	$P_D$ 71	W
Pulsed Drain Current	$t_p = 10 \mu\text{s}$	$I_{DM}$	125	A
Operating Junction and Storage Temperature	$T_J, T_{stg}$	-55 to 175		$^\circ\text{C}$
Source Current (Body Diode)	$I_S$	60		A
Single Pulse Drain-to-Source Avalanche Energy ( $V_{DD} = 50 \text{ V}, V_{GS} = 10 \text{ V}, R_G = 25 \Omega, I_{L(pk)} = 36 \text{ A}, L = 0.3 \text{ mH}, V_{DS} = 40 \text{ V}$ )	$E_{AS}$	195		mJ
Lead Temperature for Soldering Purposes (1/8" from case for 10 s)	$T_L$	260		$^\circ\text{C}$

Stresses exceeding Maximum Ratings may damage the device. Maximum Ratings are stress ratings only. Functional operation above the Recommended Operating Conditions is not implied. Extended exposure to stresses above the Recommended Operating Conditions may affect device reliability.

### THERMAL RESISTANCE MAXIMUM RATINGS

Parameter	Symbol	Value	Unit
Junction-to-Case (Drain)	$R_{\theta JC}$	2.1	$^\circ\text{C}/\text{W}$
Junction-to-Ambient – Steady State (Note 1)	$R_{\theta JA}$	106	

1. Surface-mounted on FR4 board using 1 in sq pad size (Cu area = 1.127 in sq [1 oz] including traces).

ON Semiconductor®

<http://onsemi.com>

$V_{(BR)DSS}$	$R_{DS(on)}$ MAX	$I_D$ MAX
40 V	12 m $\Omega$ @ 5.0 V	69 A
	8.5 m $\Omega$ @ 10 V	

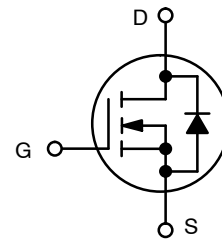

N-CHANNEL MOSFET

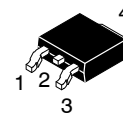

DPAK  
CASE 369C  
(Surface Mount)  
STYLE 2

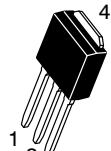

IPAK  
CASE 369D  
(Straight Lead  
DPAK)

### MARKING DIAGRAMS & PIN ASSIGNMENT

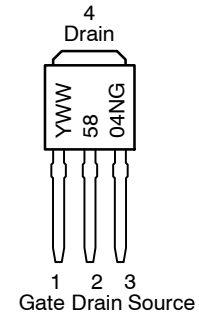
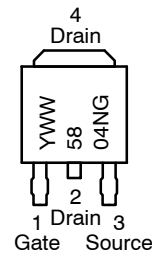

- Y = Year
- WW = Work Week
- 5804N = Device Code
- G = Pb-Free Package

### ORDERING INFORMATION

See detailed ordering and shipping information in the package dimensions section on page 5 of this data sheet.

# NTD5804N

电气特性 (T<sub>J</sub> = 25°C unless otherwise noted)

Parameter	Symbol	Test Condition	Min	Typ	Max	Unit
-----------	--------	----------------	-----	-----	-----	------

## OFF CHARACTERISTICS

Drain-to-Source Breakdown Voltage	V <sub>(BR)DSS</sub>	V <sub>GS</sub> = 0 V, I <sub>D</sub> = 250 μA	40	45		V
Drain-to-Source Breakdown Voltage Temperature Coefficient	V <sub>(BR)DSS</sub> /T <sub>J</sub>			41		mV/°C
Zero Gate Voltage Drain Current	I <sub>DSS</sub>	V <sub>GS</sub> = 0 V, V <sub>DS</sub> = 40 V	T <sub>J</sub> = 25°C		1.0	μA
			T <sub>J</sub> = 150°C		100	
Gate-to-Source Leakage Current	I <sub>GSS</sub>	V <sub>DS</sub> = 0 V, V <sub>GS</sub> = ±20 V			±100	nA

## ON CHARACTERISTICS (Note 2)

Gate Threshold Voltage	V <sub>GS(TH)</sub>	V <sub>GS</sub> = V <sub>DS</sub> , I <sub>D</sub> = 250 μA	1.5		3.5	V
Negative Threshold Temperature Coefficient	V <sub>GS(TH)</sub> /T <sub>J</sub>			7.3		mV/°C
Drain-to-Source On Resistance	R <sub>DS(on)</sub>	V <sub>GS</sub> = 10 V, I <sub>D</sub> = 30 A		5.7	8.5	mΩ
		V <sub>GS</sub> = 5 V, I <sub>D</sub> = 10 A		7.9	12	
Forward Transconductance	g <sub>FS</sub>	V <sub>DS</sub> = 15 V, I <sub>D</sub> = 15 A		12		S

## CHARGES, CAPACITANCES AND GATE RESISTANCES

Input Capacitance	C <sub>iss</sub>	V <sub>GS</sub> = 0 V, f = 1.0 MHz, V <sub>DS</sub> = 25 V		2460	2850	pF
Output Capacitance	C <sub>oss</sub>			310	400	
Reverse Transfer Capacitance	C <sub>rss</sub>			215	280	
Total Gate Charge	Q <sub>G(TOT)</sub>	V <sub>GS</sub> = 10 V, V <sub>DS</sub> = 32 V, I <sub>D</sub> = 30 A		45		nC
Threshold Gate Charge	Q <sub>G(TH)</sub>			2.8		
Gate-to-Source Charge	Q <sub>GS</sub>			10		
Gate-to-Drain Charge	Q <sub>GD</sub>			12.6		

## SWITCHING CHARACTERISTICS (Note 3)

Turn-On Delay Time	t <sub>d(on)</sub>	V <sub>GS</sub> = 10 V, V <sub>DD</sub> = 32 V, I <sub>D</sub> = 30 A, R <sub>G</sub> = 2.5 Ω		11.8		ns
Rise Time	t <sub>r</sub>			18.7		
Turn-Off Delay Time	t <sub>d(off)</sub>			26.8		
Fall Time	t <sub>f</sub>			5.9		

## DRAIN-SOURCE DIODE CHARACTERISTICS

Forward Diode Voltage	V <sub>SD</sub>	V <sub>GS</sub> = 0 V, I <sub>S</sub> = 10 A	T <sub>J</sub> = 25°C		0.81	1.2	V
			T <sub>J</sub> = 150°C		0.63		
Reverse Recovery Time	t <sub>RR</sub>	V <sub>GS</sub> = 0 V, dI <sub>S</sub> /dt = 100 A/μs, I <sub>S</sub> = 30 A		21.7		ns	
Charge Time	t <sub>a</sub>			11.9			
Discharge Time	t <sub>b</sub>			9.8			
Reverse Recovery Charge	Q <sub>RR</sub>			11.8			nC

- Pulse Test: Pulse Width ≤ 300 μs, Duty Cycle ≤ 2%.
- Switching characteristics are independent of operating junction temperatures.

TYPICAL CHARACTERISTICS

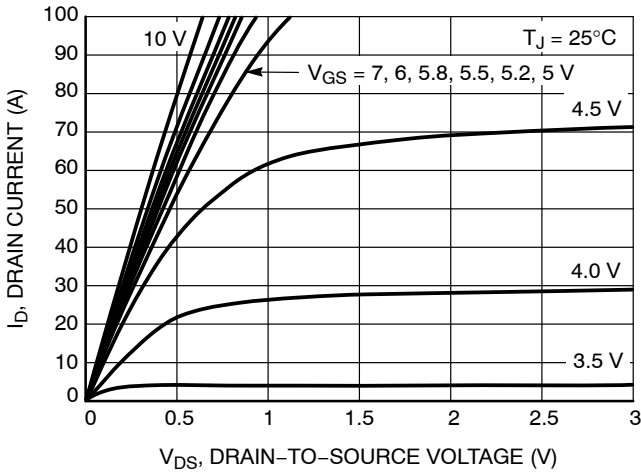

Figure 1. On-Region Characteristics

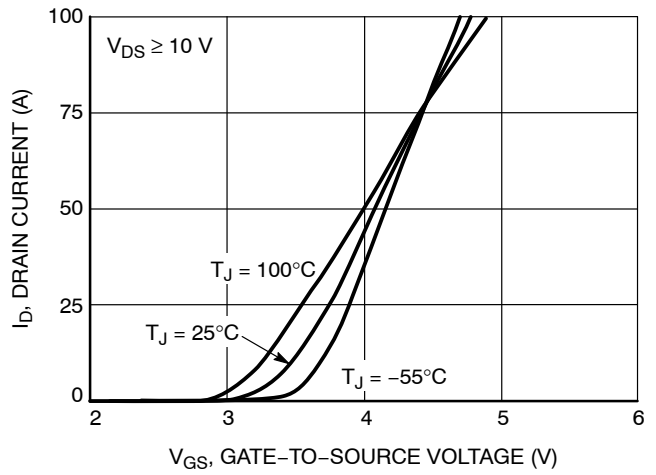

Figure 2. Transfer Characteristics

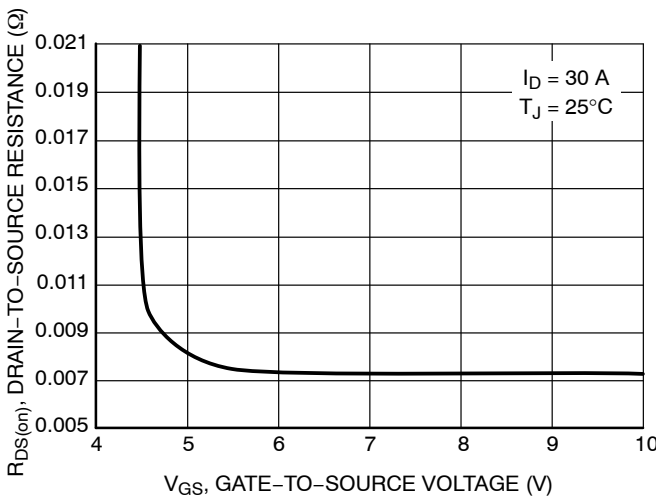

Figure 3. On-Resistance vs. Drain Current

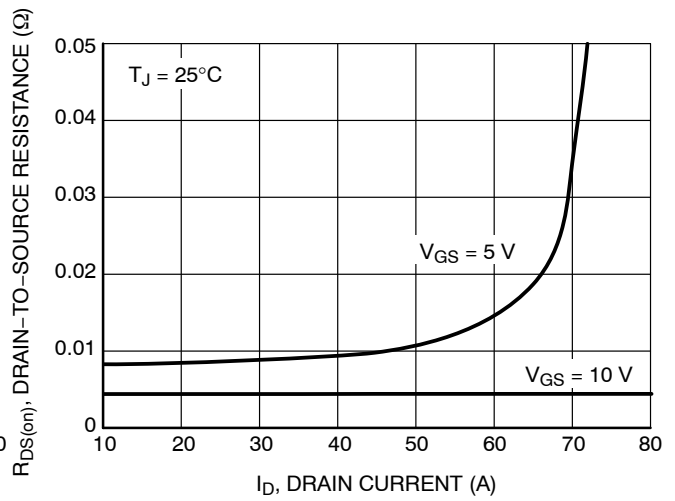

Figure 4. On-Resistance vs. Drain Current and Gate Voltage

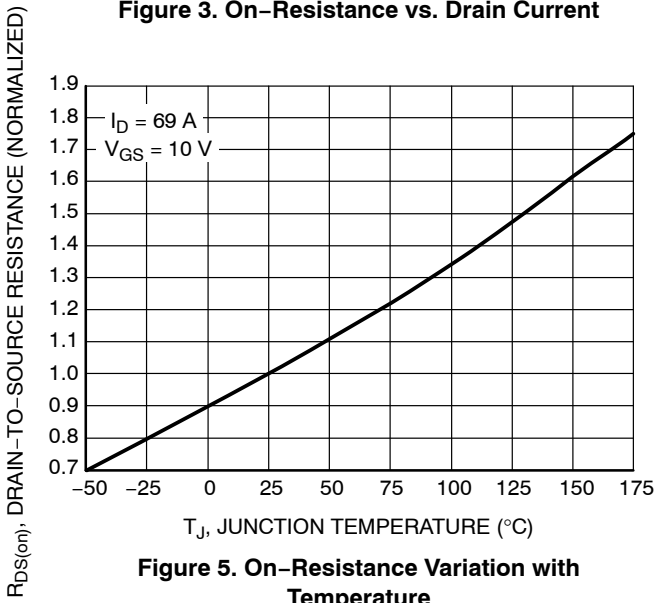

Figure 5. On-Resistance Variation with Temperature

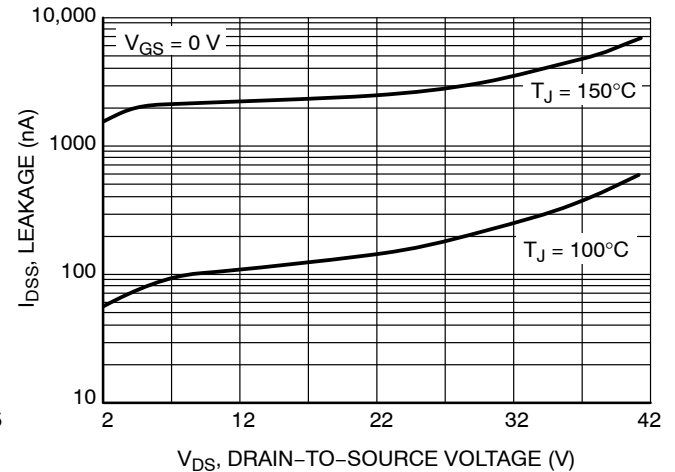

Figure 6. Drain-to-Source Leakage Current vs. Voltage

TYPICAL CHARACTERISTICS

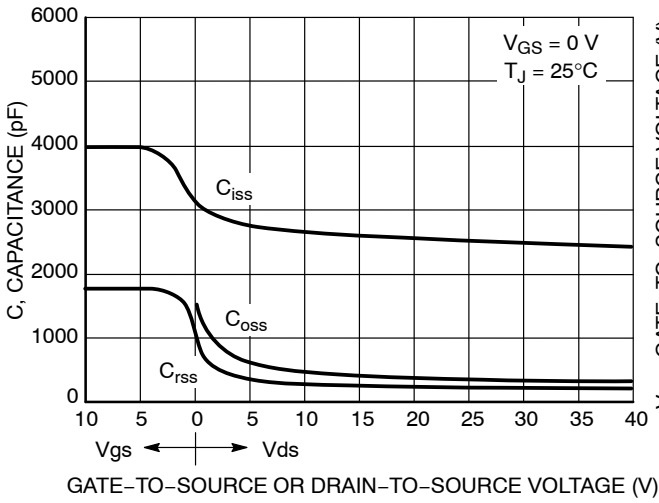

Figure 7. Capacitance Variation

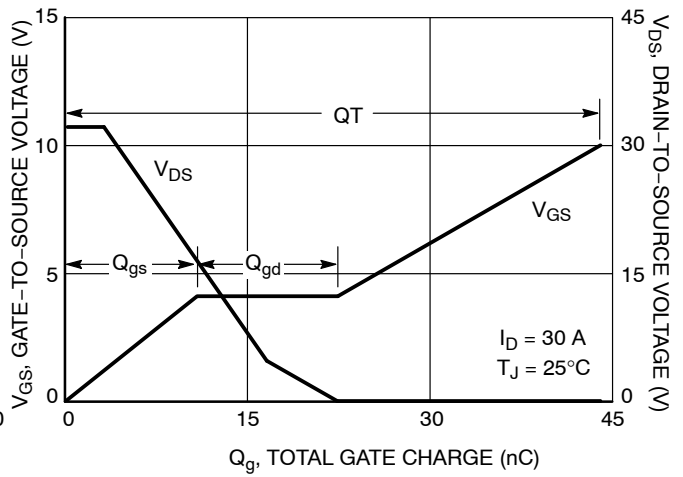

Figure 8. Gate-to-Source and Drain-to-Source Voltage vs. Total Charge

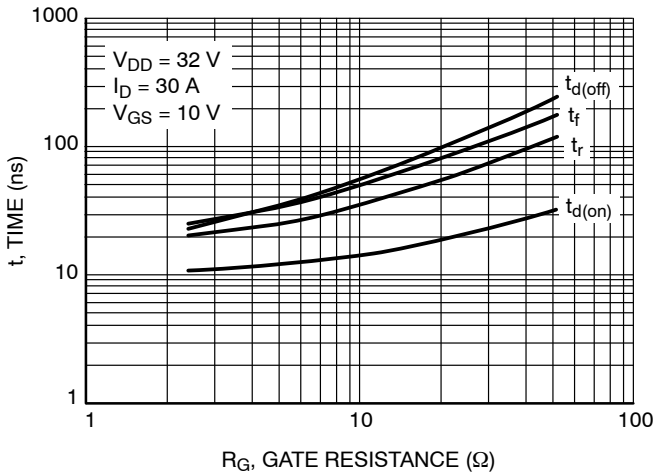

Figure 9. Resistive Switching Time Variation vs. Gate Resistance

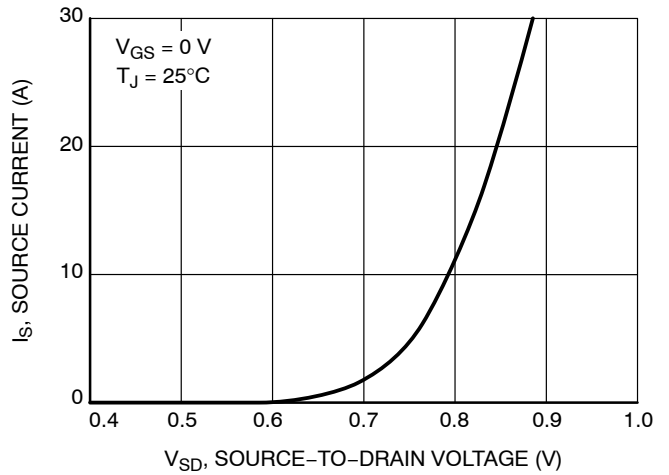

Figure 10. Diode Forward Voltage vs. Current

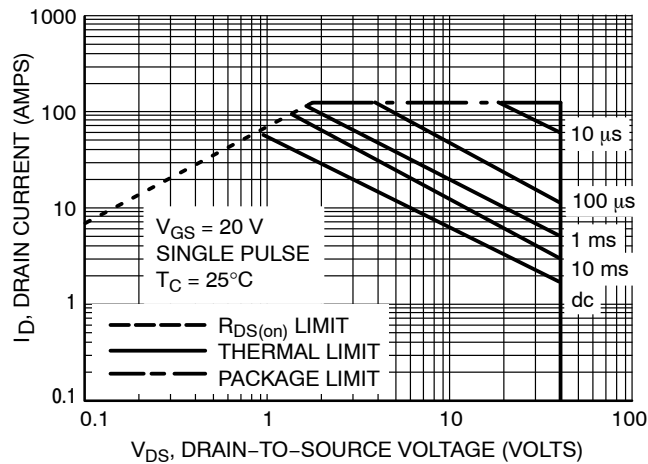
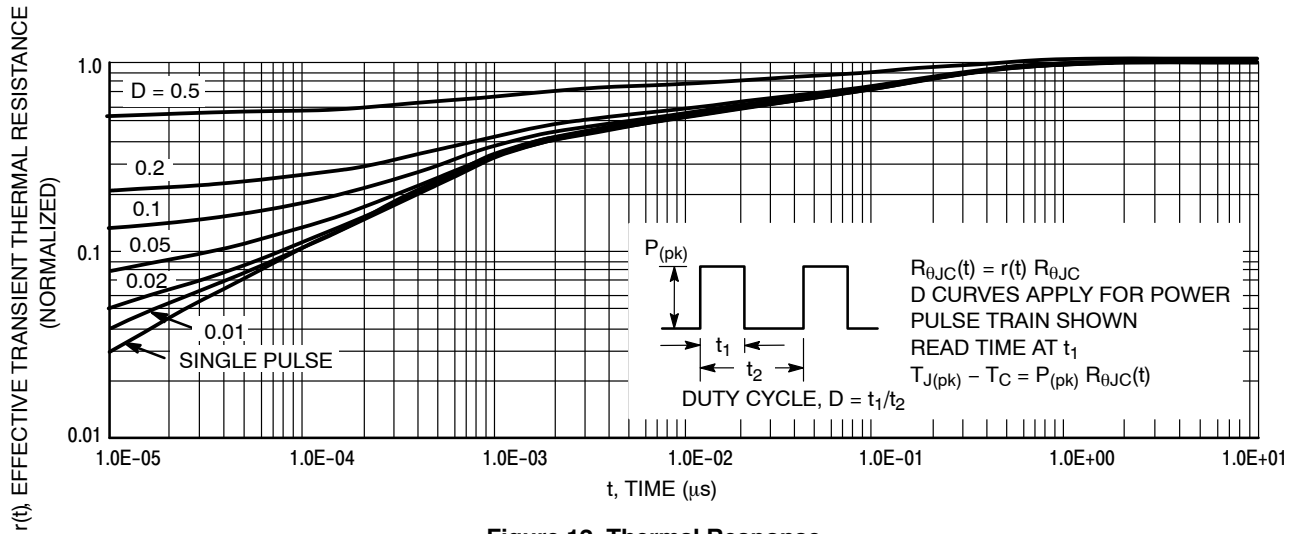

Figure 11. Maximum Rated Forward Biased Safe Operating Area

# NTD5804N

[查询"NTD5804N-D"供应商](#)

## TYPICAL PERFORMANCE CURVES



### ORDERING INFORMATION

Order Number	Package	Shipping <sup>†</sup>
NTD5804NG	IPAK (Straight Lead DPAK) (Pb-Free)	75 Units / Rail
NTD5804NT4G	DPAK (Pb-Free)	2500 / Tape & Reel

<sup>†</sup>For information on tape and reel specifications, including part orientation and tape sizes, please refer to our Tape and Reel Packaging Specifications Brochure, BRD8011/D.

# NTD5804N

[查询"NTD5804N-D"供应商](#)

## PACKAGE DIMENSIONS

DPAK  
CASE 369C-01  
ISSUE O

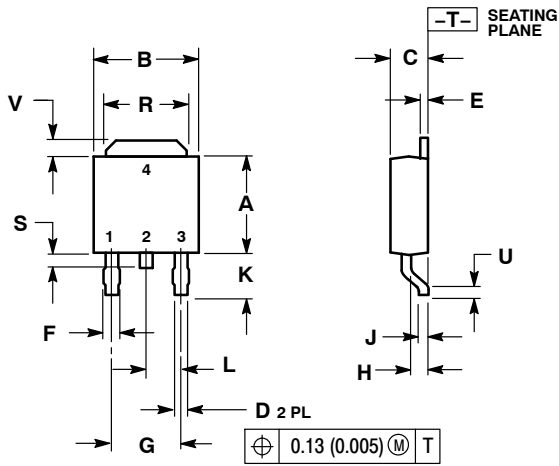

- NOTES:  
1. DIMENSIONING AND TOLERANCING PER ANSI Y14.5M, 1982.  
2. CONTROLLING DIMENSION: INCH.

DIM	INCHES		MILLIMETERS	
	MIN	MAX	MIN	MAX
A	0.235	0.245	5.97	6.22
B	0.250	0.265	6.35	6.73
C	0.086	0.094	2.19	2.38
D	0.027	0.035	0.69	0.88
E	0.018	0.023	0.46	0.58
F	0.037	0.045	0.94	1.14
G	0.180 BSC		4.58 BSC	
H	0.034	0.040	0.87	1.01
J	0.018	0.023	0.46	0.58
K	0.102	0.114	2.60	2.89
L	0.090 BSC		2.29 BSC	
R	0.180	0.215	4.57	5.45
S	0.025	0.040	0.63	1.01
U	0.020	---	0.51	---
V	0.035	0.050	0.89	1.27
Z	0.155	---	3.93	---

- STYLE 2:  
PIN 1. GATE  
2. DRAIN  
3. SOURCE  
4. DRAIN

### SOLDERING FOOTPRINT\*

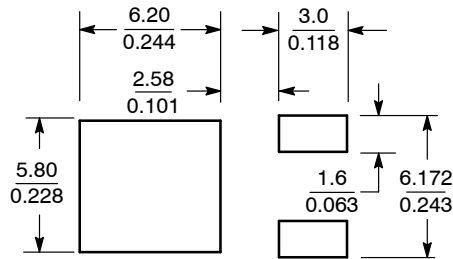

SCALE 3:1  $\left( \frac{\text{mm}}{\text{inches}} \right)$

\*For additional information on our Pb-Free strategy and soldering details, please download the ON Semiconductor Soldering and Mounting Techniques Reference Manual, SOLDERRM/D.

# NTD5804N

[查询"NTD5804N-D"供应商](#)

## PACKAGE DIMENSIONS

### IPAK (STRAIGHT LEAD DPAK) CASE 369D-01 ISSUE B

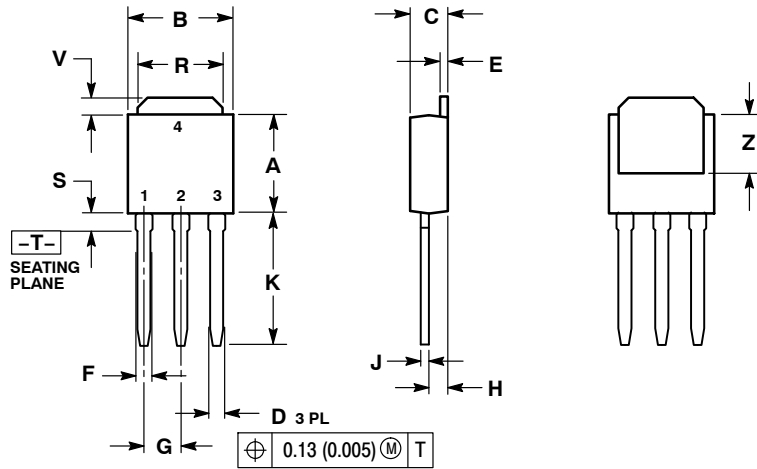

- NOTES:  
1. DIMENSIONING AND TOLERANCING PER ANSI Y14.5M, 1982.  
2. CONTROLLING DIMENSION: INCH.

DIM	INCHES		MILLIMETERS	
	MIN	MAX	MIN	MAX
A	0.235	0.245	5.97	6.35
B	0.250	0.265	6.35	6.73
C	0.086	0.094	2.19	2.38
D	0.027	0.035	0.69	0.88
E	0.018	0.023	0.46	0.58
F	0.037	0.045	0.94	1.14
G	0.090 BSC		2.29 BSC	
H	0.034	0.040	0.87	1.01
J	0.018	0.023	0.46	0.58
K	0.350	0.380	8.89	9.65
R	0.180	0.215	4.45	5.45
S	0.025	0.040	0.63	1.01
V	0.035	0.050	0.89	1.27
Z	0.155	---	3.93	---

- STYLE 2:  
PIN 1: GATE  
2. DRAIN  
3. SOURCE  
4. DRAIN

ON Semiconductor and are registered trademarks of Semiconductor Components Industries, LLC (SCILLC). SCILLC reserves the right to make changes without further notice to any products herein. SCILLC makes no warranty, representation or guarantee regarding the suitability of its products for any particular purpose, nor does SCILLC assume any liability arising out of the application or use of any product or circuit, and specifically disclaims any and all liability, including without limitation special, consequential or incidental damages. "Typical" parameters which may be provided in SCILLC data sheets and/or specifications can and do vary in different applications and actual performance may vary over time. All operating parameters, including "Typicals" must be validated for each customer application by customer's technical experts. SCILLC does not convey any license under its patent rights nor the rights of others. SCILLC products are not designed, intended, or authorized for use as components in systems intended for surgical implant into the body, or other applications intended to support or sustain life, or for any other application in which the failure of the SCILLC product could create a situation where personal injury or death may occur. Should Buyer purchase or use SCILLC products for any such unintended or unauthorized application, Buyer shall indemnify and hold SCILLC and its officers, employees, subsidiaries, affiliates, and distributors harmless against all claims, costs, damages, and expenses, and reasonable attorney fees arising out of, directly or indirectly, any claim of personal injury or death associated with such unintended or unauthorized use, even if such claim alleges that SCILLC was negligent regarding the design or manufacture of the part. SCILLC is an Equal Opportunity/Affirmative Action Employer. This literature is subject to all applicable copyright laws and is not for resale in any manner.

## PUBLICATION ORDERING INFORMATION

**LITERATURE FULFILLMENT:**  
Literature Distribution Center for ON Semiconductor  
P.O. Box 5163, Denver, Colorado 80217 USA  
**Phone:** 303-675-2175 or 800-344-3860 Toll Free USA/Canada  
**Fax:** 303-675-2176 or 800-344-3867 Toll Free USA/Canada  
**Email:** orderlit@onsemi.com

**N. American Technical Support:** 800-282-9855 Toll Free  
USA/Canada  
**Europe, Middle East and Africa Technical Support:**  
Phone: 421 33 790 2910  
**Japan Customer Focus Center**  
Phone: 81-3-5773-3850

**ON Semiconductor Website:** [www.onsemi.com](http://www.onsemi.com)  
**Order Literature:** <http://www.onsemi.com/orderlit>  
For additional information, please contact your local Sales Representative