

ADC-007

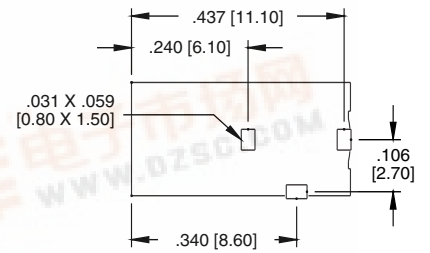

ADC-007-3

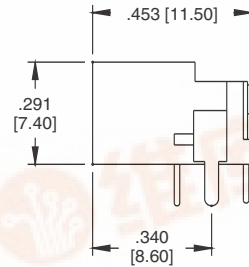
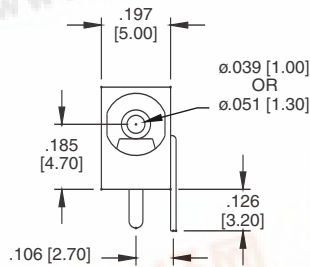

Recommended PCB Layout

ADC-009



ADC-009-3

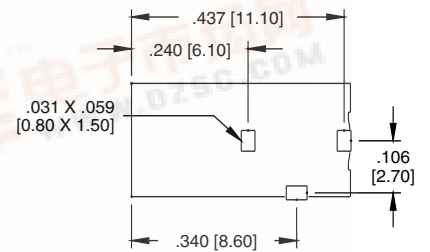
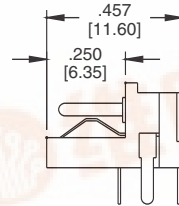
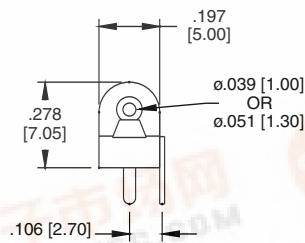

Recommended PCB Layout

ADC-011

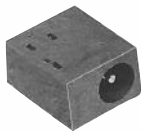

ADC-011-3

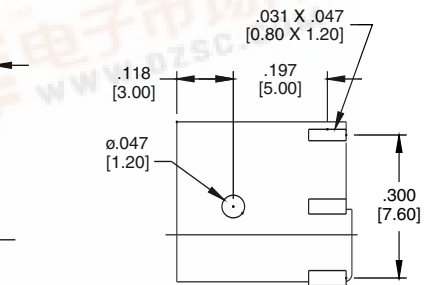
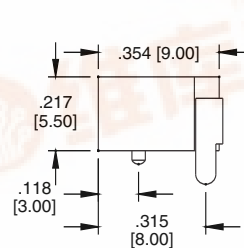
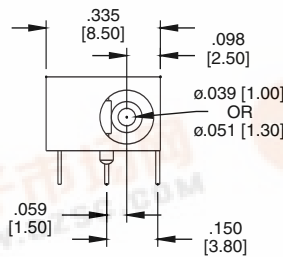

Recommended PCB Layout

ADC-021

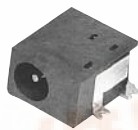

ADC-021-3

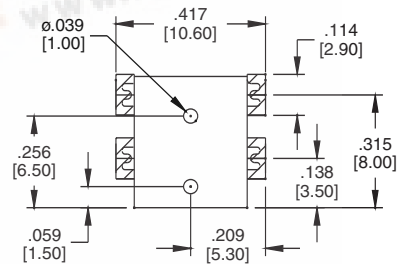
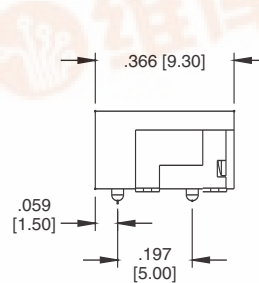
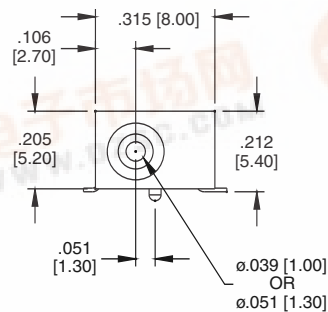

Recommended PCB Layout

ADC-029



ADC-029-1

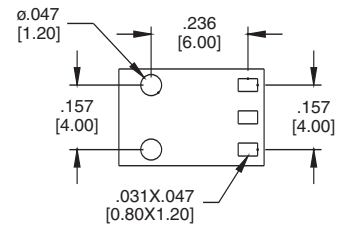
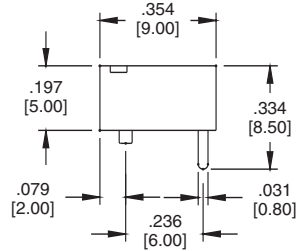
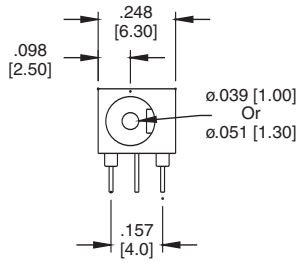

Recommended PCB Layout

ADC-002



ADC-002-2

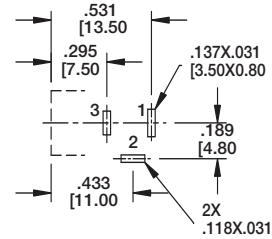
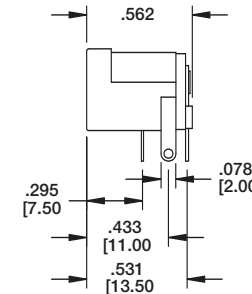
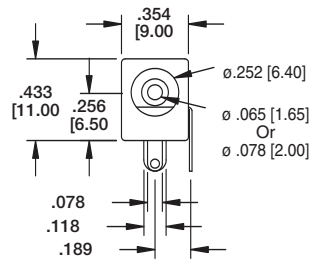

Recommended PCB Layout

ADC-024



ADC-024-8

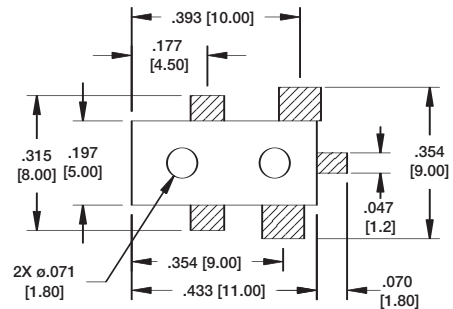
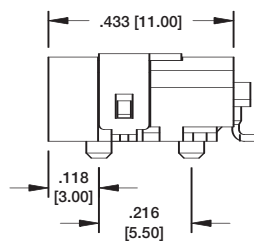
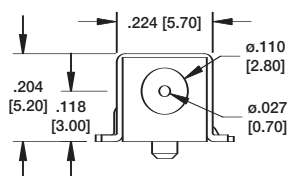

Recommended PCB Layout

ADC-028



ADC-028-2

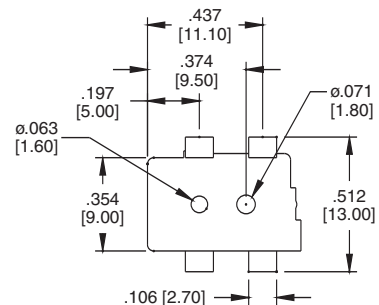
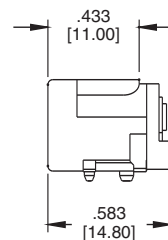
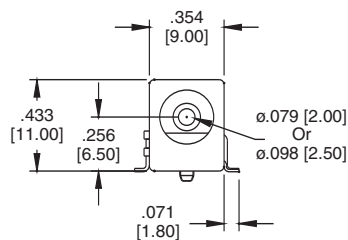

Recommended PCB Layout

ADC-010



ADC-010-1

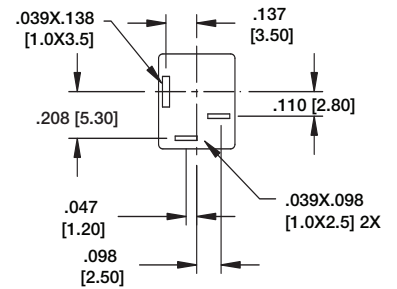
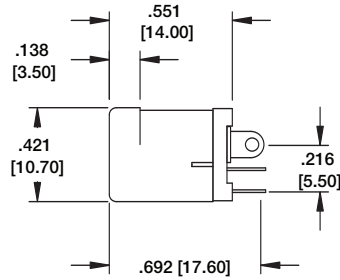
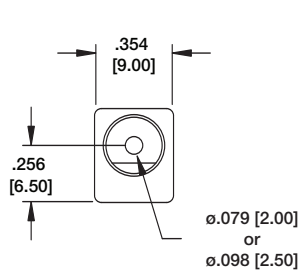

Recommended PCB Layout

ADC-015



ADC-015-2

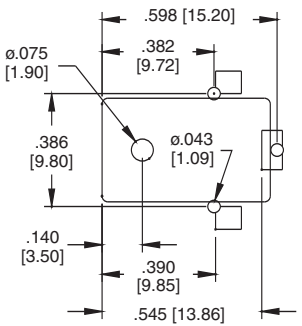
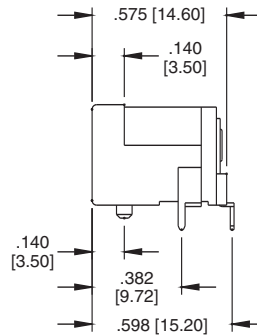
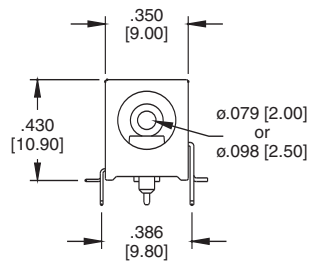

Recommended PCB Layout

ADC-045A



ADC-045A-1

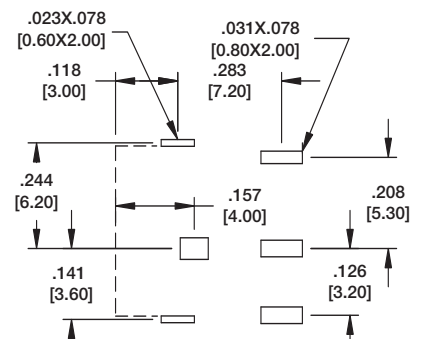
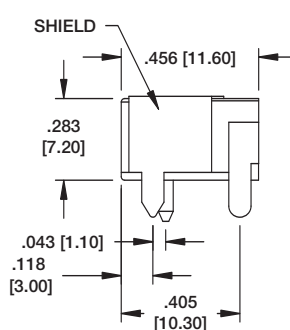
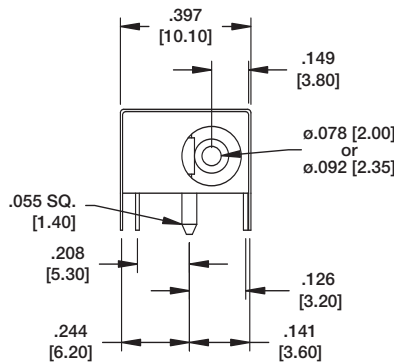

Recommended PCB Layout

DC POWER PLUG WITH STRAIN RELIEF

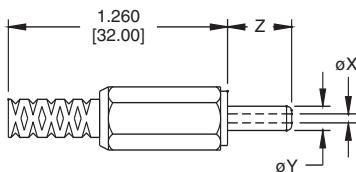

DC POWER PLUG WITHOUT STRAIN RELIEF

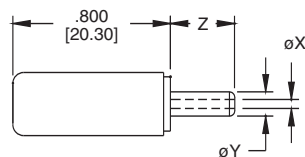

PLUG WITH STRAIN RELIEF	X	Y	Z
ADP-X/Y/Z-SR	ø.039 [1.00]	ø.137 [3.50]	.374 [9.50]
ADP-X/Y/Z-SR	ø.082 [2.10]	ø.216 [5.50]	.374 [9.50]
ADP-X/Y/Z-SR	ø.098 [2.50]	ø.216 [5.50]	.374 [9.50]

PLUG WITHOUT STRAIN RELIEF	X	Y	Z
ADP-X/Y/Z	ø.039 [1.00]	ø.137 [3.50]	.374 [9.50]
ADP-X/Y/Z	ø.082 [2.10]	ø.216 [5.50]	.374 [9.50]
ADP-X/Y/Z	ø.098 [2.50]	ø.216 [5.50]	.374 [9.50]