

**FAIRCHILD**  
SEMICONDUCTOR®

July 1997  
Revised April 2005

## 74VHCT574A Octal D-Type Flip-Flop with 3-STATE Outputs

### General Description

The VHCT574A is an advanced high speed CMOS octal flip-flop with 3-STATE output fabricated with silicon gate CMOS technology. It achieves the high speed operation similar to equivalent Bipolar Schottky TTL while maintaining the CMOS low power dissipation. This 8-bit D-type flip-flop is controlled by a clock input (CP) and an Output Enable input (OE). When the OE input is HIGH, the eight outputs are in a high impedance state.

Protection circuits ensure that 0V to 7V can be applied to the input and output (Note 1) pins without regard to the supply voltage. This device can be used to interface 3V to 5V systems and two supply systems such as battery back up. This circuit prevents device destruction due to mismatched supply and input voltages.

**Note 1:** Outputs in OFF-State.

### Features

- High speed:  $f_{MAX} = 140$  MHz (typ) at  $T_A = 25^\circ\text{C}$
- Power Down Protection is provided on all inputs and outputs.
- Low Noise:  $V_{OLP} = 1.6\text{V}$  (max)
- Low Power Dissipation:  
 $I_{CC} = 4 \mu\text{A}$  (max) @  $T_A = 25^\circ\text{C}$
- Pin and Function Compatible with 74HCT574

### Ordering Code:

Order Number	Package Number	Package Description
74VHCT574AM	M20B	20-Lead Small Outline Integrated Circuit (SOIC), JEDEC MS-013, 0.300" Wide
74VHCT574ASJ	M20D	Pb-Free 20-Lead Small Outline Package (SOP), EIAJ TYPE II, 5.3mm Wide
74VHCT574AMTC	MTC20	20-Lead Thin Shrink Small Outline Package (TSSOP), JEDEC MO-153, 4.4mm Wide
74VHCT574AN	N20A	20-Lead Plastic Dual-In-Line Package (PDIP), JEDEC MS-001, 0.300" Wide

Surface mount packages are also available on Tape and Reel. Specify by appending the suffix letter "X" to the ordering code.  
Pb-Free package per JEDEC J-STD-020B.

### Logic Symbol

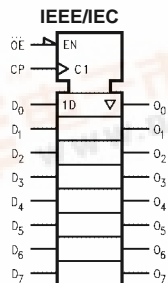

### Connection Diagram

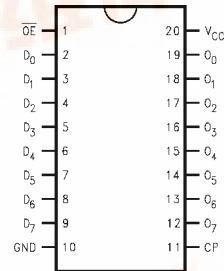

74VHCT574A

### Pin Descriptions

Pin Names	Description
D <sub>0</sub> -D <sub>7</sub>	Data Inputs
CP	Clock Pulse Input 3-STATE
$\overline{OE}$	Output Enable Input 3-STATE
O <sub>0</sub> -O <sub>7</sub>	Outputs

### Truth Table

Inputs			Outputs
D <sub>n</sub>	CP	$\overline{OE}$	O <sub>n</sub>
H	↗	L	H
L	↗	L	L
X	X	H	Z

H = HIGH Voltage Level  
 L = LOW Voltage Level  
 X = Immaterial  
 Z = High Impedance  
 ↗ = LOW-to-HIGH Transition

### Functional Description

The VHCT574A consists of eight edge-triggered flip-flops with individual D-type inputs and 3-STATE true outputs. The buffered clock and buffered Output Enable are common to all flip-flops. The eight flip-flops will store the state of their individual D inputs that meet the setup and hold time requirements on the LOW-to-HIGH Clock (CP) transi-

tion. With the Output Enable ( $\overline{OE}$ ) LOW, the contents of the eight flip-flops are available at the outputs. When the OE is HIGH, the outputs go to the high impedance state. Operation of the  $\overline{OE}$  input does not affect the state of the flip-flops.

### Logic Diagram

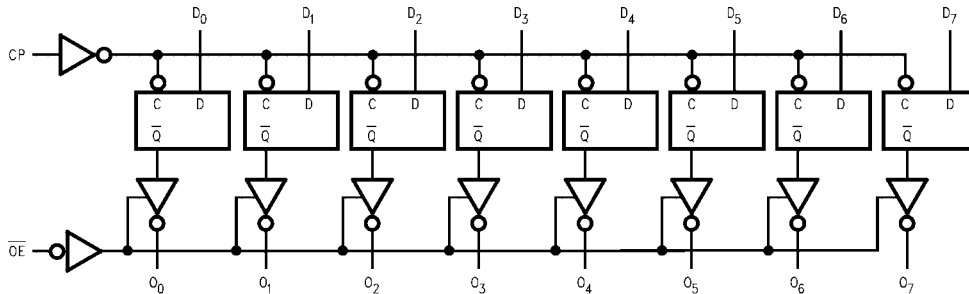

Please note that this diagram is provided only for the understanding of logic operations and should not be used to estimate propagation delays.

Absolute Maximum Ratings (Note 2)			Recommended Operating Conditions (Note 6)		
Supply Voltage ( $V_{CC}$ )	-0.5V to +7.0V		Supply Voltage ( $V_{CC}$ )	4.5V to +5.5V	
DC Input Voltage ( $V_{IN}$ )	-0.5V to +7.0V		Input Voltage ( $V_{IN}$ )	0V to +5.5V	
DC Output Voltage ( $V_{OUT}$ )	-0.5V to $V_{CC} + 0.5V$		Output Voltage ( $V_{OUT}$ )	0V to $V_{CC}$	
(Note 3)			(Note 3)	0V to +5.5V	
(Note 4)	-0.5V to +7.0V		(Note 4)	0V to +5.5V	
Input Diode Current ( $I_{IK}$ )	-20 mA		Operating Temperature ( $T_{OPR}$ )	-40°C to +85°C	
Output Diode Current ( $I_{OK}$ ) (Note 5)	±20 mA		Input Rise and Fall Time ( $t_r, t_f$ )	0 ns/V ~ 20 ns/V	
DC Output Current ( $I_{OUT}$ )	±25 mA		$V_{CC} = 5.0V \pm 0.5V$		
DC $V_{CC}/GND$ Current ( $I_{CC}$ )	±75 mA				
Storage Temperature ( $T_{STG}$ )	-65°C to +150°C				
Lead Temperature ( $T_L$ )					
(Soldering, 10 seconds)	260°C				

**Note 2:** Absolute Maximum Ratings are values beyond which the device may be damaged or have its useful life impaired. The databook specifications should be met, without exception, to ensure that the system design is reliable over its power supply, temperature, and output/input loading variables. Fairchild does not recommend operation outside databook specifications.

**Note 3:** HIGH or LOW state.  $I_{OUT}$  absolute maximum rating must be observed.

**Note 4:** When outputs are in OFF-State or when  $V_{CC} = 0V$ .

**Note 5:**  $V_{OUT} < GND, V_{OUT} > V_{CC}$  (Outputs Active).

**Note 6:** Unused inputs must be held HIGH or LOW. They may not float.

### DC Electrical Characteristics

Symbol	Parameter	$V_{CC}$ (V)	$T_A = 25^\circ C$			$T_A = -40^\circ C$ to $+85^\circ C$		Units	Conditions
			Min	Typ	Max	Min	Max		
$V_{IH}$	HIGH Level Input Voltage	4.5	2.0			2.0	V		
		5.5	2.0			20			
$V_{IL}$	LOW Level Input Voltage	4.5			0.8	0.8	V		
		5.5			0.8	0.8			
$V_{OH}$	HIGH Level Output Voltage	4.5	4.40	4.50		4.40	V	$V_{IN} = V_{IH}$ $I_{OH} = -50 \mu A$	
			3.94			3.80	V	or $V_{IL}$ $I_{OH} = -8 \text{ mA}$	
$V_{OL}$	LOW Level Output Voltage	4.5	0.0	0.1		0.1	V	$V_{IN} = V_{IH}$ $I_{OL} = 50 \mu A$	
				0.36		0.44	V	or $V_{IL}$ $I_{OL} = 8 \text{ mA}$	
$I_{OZ}$	3-STATE Output Off-State Current	5.5		±0.25		±2.5	$\mu A$	$V_{IN} = V_{IH}$ or $V_{IL}$ $V_{OUT} = V_{CC}$ or GND	
$I_{IN}$	Input Leakage Current	0-5.5		±0.1		±1.0	$\mu A$	$V_{IN} = 5.5V$ or GND	
$I_{CC}$	Quiescent Supply Current	5.5		4.0		40.0	$\mu A$	$V_{IN} = V_{CC}$ or GND	
$I_{CCT}$	Maximum $I_{CC}/Input$	5.5		1.35		1.50	mA	$V_{IN} = 3.4V$ Other Input = $V_{CC}$ or GND	
$I_{OFF}$	Output Leakage Current (Power Down State)	0.0		0.5		5.0	$\mu A$	$V_{OUT} = 5.5V$	

74VHCT574A

Noise Characteristics										
Symbol	Parameter	V <sub>CC</sub> (V)	T <sub>A</sub> = 25°C		Units	Conditions				
			Typ	Limits						
V <sub>OLP</sub> (Note 7)	Quiet Output Maximum Dynamic V <sub>OL</sub>	5.0	1.2	1.6	V	C <sub>L</sub> = 50 pF				
V <sub>OLV</sub> (Note 7)	Quiet Output Minimum Dynamic V <sub>OL</sub>	5.0	-1.2	-1.6	V	C <sub>L</sub> = 50 pF				
V <sub>IHD</sub> (Note 7)	Minimum HIGH Level Dynamic Input Voltage	5.0	2.0		V	C <sub>L</sub> = 50 pF				
V <sub>ILD</sub> (Note 7)	Maximum LOW Level Dynamic Input Voltage	5.0	0.8		V	C <sub>L</sub> = 50 pF				
<b>Note 7:</b> Parameter guaranteed by design.										
AC Electrical Characteristics										
Symbol	Parameter	V <sub>CC</sub> (V)	T <sub>A</sub> = 25°C			T <sub>A</sub> = -40°C to +85°C		Units	Conditions	
			Min	Typ	Max	Min	Max			
t <sub>PLH</sub>	Propagation Delay Time	5.0 ± 0.5	4.1	9.4	1.0	10.5	ns	C <sub>L</sub> = 15 pF		
t <sub>PHL</sub>			5.6	10.4	1.0	11.5		C <sub>L</sub> = 50 pF		
t <sub>PZL</sub>	3-STATE Output Enable Time	5.0 ± 0.5	6.5	10.2	1.0	11.5	ns	R <sub>L</sub> = 1 kΩ	C <sub>L</sub> = 15 pF	
t <sub>PZH</sub>			7.3	11.2	1.0	12.5			C <sub>L</sub> = 50 pF	
t <sub>PLZ</sub>	3-STATE Output Disable Time	5.0 ± 0.5	7.0	11.2	1.0	12.0	ns	R <sub>L</sub> = 1 kΩ	C <sub>L</sub> = 50 pF	
t <sub>PHZ</sub>			1.0		1.0				(Note 8)	
t <sub>OSLH</sub>	Output to Output Skew	5.0 ± 0.5	1.0		1.0		ns	(Note 8)		
t <sub>OSHL</sub>			1.0		1.0			(Note 8)		
f <sub>MAX</sub>	Maximum Clock Frequency	5.0 ± 0.5	90	140	80		MHz	C <sub>L</sub> = 15 pF		
			85	130	75	C <sub>L</sub> = 50 pF				
C <sub>IN</sub>	Input Capacitance		4	10	10		pF	V <sub>CC</sub> = Open		
C <sub>OUT</sub>	Output Capacitance		9				pF	V <sub>CC</sub> = 5.0V		
C <sub>PD</sub>	Power Dissipation Capacitance		25				pF	(Note 9)		
<b>Note 8:</b> Parameter guaranteed by design. t <sub>OSLH</sub> =  t <sub>PLH max</sub> - t <sub>PLH min</sub>  ; t <sub>OSHL</sub> =  t <sub>PHL max</sub> - t <sub>PHL min</sub>										
<b>Note 9:</b> C <sub>PD</sub> is defined as the value of the internal equivalent capacitance which is calculated from the operating current consumption without load. Average operating current can be obtained by the equation: I <sub>CC (opr.)</sub> = C <sub>PD</sub> * V <sub>CC</sub> * f <sub>IN</sub> + I <sub>CC/8</sub> (per F/F). The total C <sub>PD</sub> when n pcs. of the Octal D Flip-Flop operates can be calculated by the equation: C <sub>PD (total)</sub> = 20 + 12n.										
AC Operating Requirements										
Symbol	Parameter	V <sub>CC</sub> (V)	T <sub>A</sub> = 25°C			T <sub>A</sub> = -40°C to +85°C		Units		
			Min	Typ	Max	Min	Max			
t <sub>W(H)</sub>	Minimum Pulse Width (CP)	5.0 ± 0.5	6.5			8.5		ns		
t <sub>W(L)</sub>			6.5			8.5				
t <sub>S</sub>	Minimum Set-Up Time	5.0 ± 0.5	2.5			2.5		ns		
t <sub>H</sub>	Minimum Hold Time	5.0 ± 0.5	2.5			2.5				

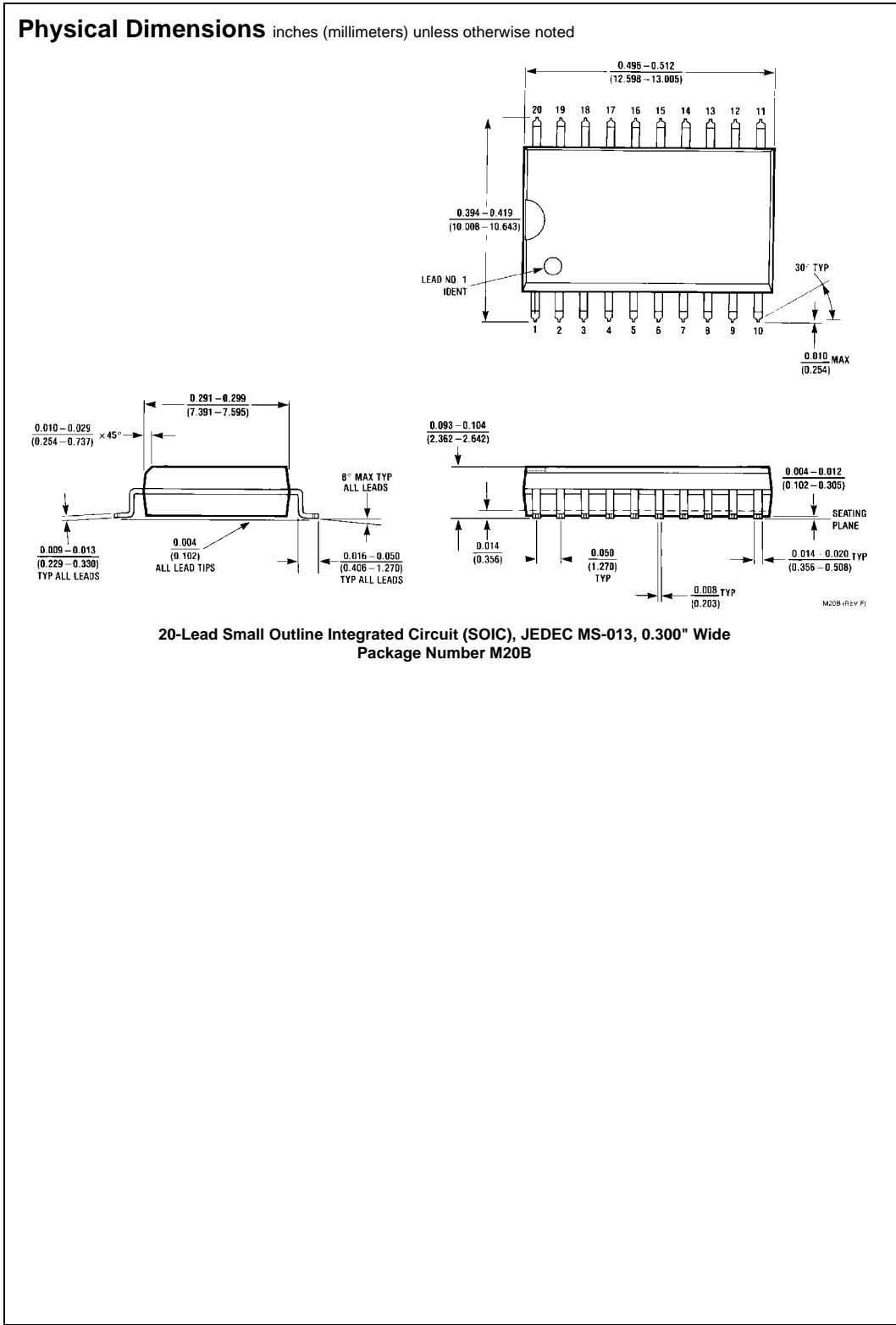

74VHCT574A

**Physical Dimensions** inches (millimeters) unless otherwise noted (Continued)

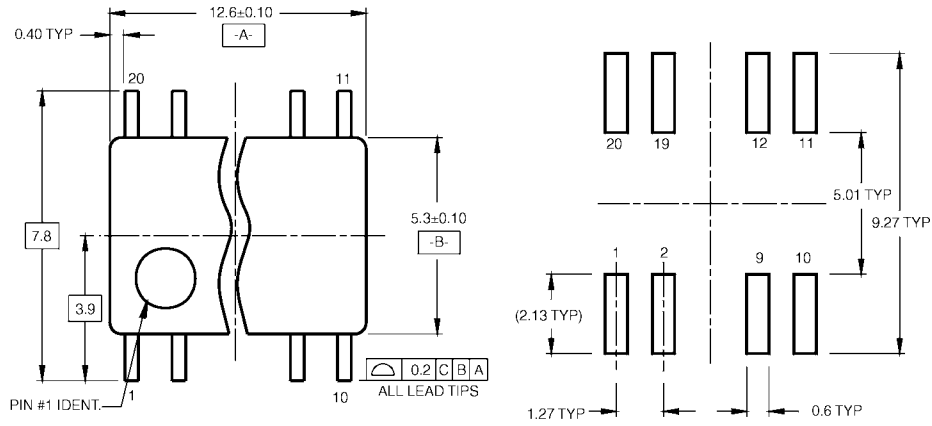

LAND PATTERN RECOMMENDATION



DIMENSIONS ARE IN MILLIMETERS



DETAIL A

NOTES:

- A. CONFORMS TO EIAJ EDR-7320 REGISTRATION, ESTABLISHED IN DECEMBER, 1998.
- B. DIMENSIONS ARE IN MILLIMETERS.
- C. DIMENSIONS ARE EXCLUSIVE OF BURRS, MOLD FLASH, AND TIE BAR EXTRUSIONS.

M20DRevB1

**Pb-Free 20-Lead Small Outline Package (SOP), EIAJ TYPE II, 5.3mm Wide  
Package Number M20D**

**Physical Dimensions** inches (millimeters) unless otherwise noted (Continued)

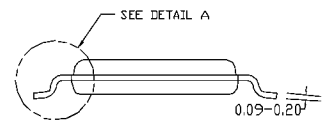
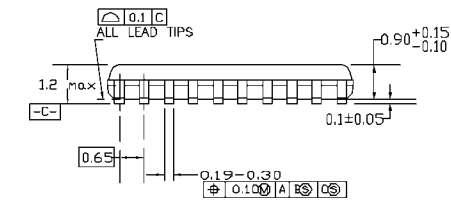
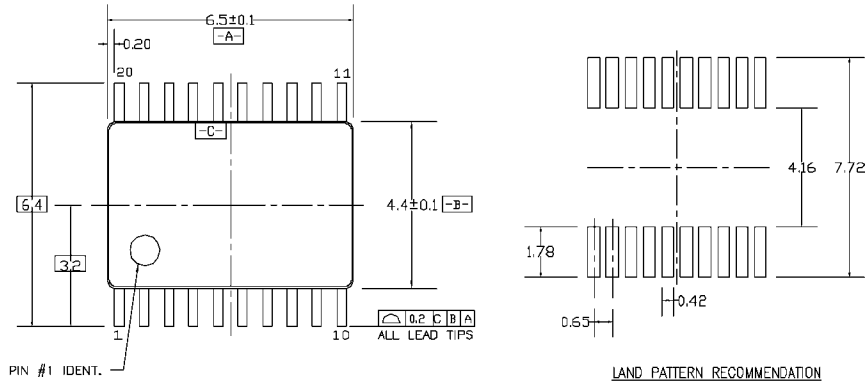

DIMENSIONS ARE IN MILLIMETERS

- NOTES:
- A. CONFORMS TO JEDEC REGISTRATION MO-153, VARIATION AC, REF NOTE 6, DATE 7/93.
  - B. DIMENSIONS ARE IN MILLIMETERS.
  - C. DIMENSIONS ARE EXCLUSIVE OF BURRS, MOLDS FLASH, AND TIE BAR EXTRUSIONS.
  - D. DIMENSIONS AND TOLERANCES PER ANSI Y14.5M, 1982.

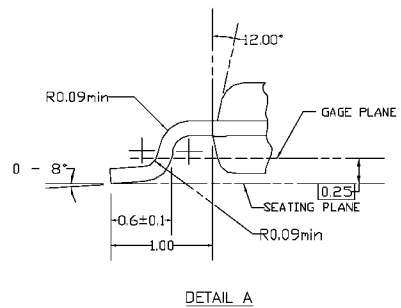

MTC20REVD1

**20-Lead Thin Shrink Small Outline Package (TSSOP), JEDEC MO-153, 4.4mm Wide Package Number MTC20**

74VHCT574A Octal D-Type Flip-Flop with 3-STATE Outputs

