

Adjustable Overvoltage Protector with High Accuracy

General Description

The MAX14527/MAX14528 overvoltage protection devices feature a low 100mΩ (typ) R_{ON} internal FET and protect low-voltage systems against voltage faults up to +28V. When the input voltage exceeds the overvoltage threshold, the internal FET is turned off to prevent damage to the protected components.

The overvoltage protection threshold can be adjusted with optional external resistors to any voltage between 4V and 8V. With the OVLO input set below the external OVLO select voltage, the MAX14527/MAX14528 automatically choose the internal ±2.5% accurate trip thresholds. The internal overvoltage thresholds (OVLO) are preset to 5.75V typical (MAX14527) or 6.76V typical (MAX14528). The MAX14527/MAX14528 are also protected against overcurrent events with an internal thermal shutdown.

The MAX14527/MAX14528 are offered in a small, 8-pin TDFN-EP package and operate over the -40°C to +85°C extended temperature range.

Applications

Cell Phones
Media Players
PDAs and Palmtop Devices

Pin Configuration appears at end of data sheet.

Features

- ◆ Input Voltage Protection Up to +28V
- ◆ Preset Internal ±2.5% Accurate OVLO Thresholds
5.75V (MAX14527)
6.76V (MAX14528)
- ◆ Adjustable Overvoltage Protection Trip Level
- ◆ Integrated 100mΩ (typ) n-Channel MOSFET Switch
- ◆ Soft-Start to Minimize In-Rush Current
- ◆ Automatic Overvoltage Protection Trip-Level Selection
- ◆ Internal 15ms Startup Delay
- ◆ Thermal Shutdown Protection
- ◆ 8-Pin TDFN (2mm x 2mm) Package
- ◆ -40°C to +85°C Operating Temperature Range

Ordering Information

PART	PIN-PACKAGE	TOP MARK	OVLO (V)
MAX14527ETA+T	8 TDFN-EP*	ACR	5.75
MAX14528ETA+T	8 TDFN-EP*	ACS	6.76

Note: Devices are specified over the -40°C to +85°C temperature range.

+ Denotes a lead-free/RoHS-compliant package.

T = Tape and reel.

*EP = Exposed pad.

Typical Application Circuit

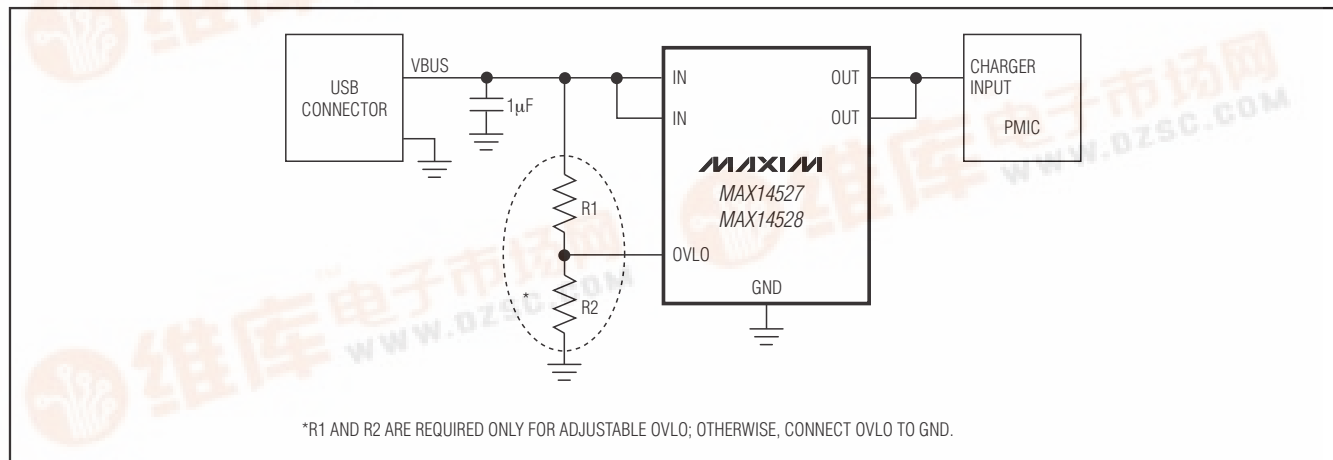

Adjustable Overvoltage Protector with High Accuracy

ABSOLUTE MAXIMUM RATINGS

(All voltages referenced to GND.)

IN	-0.3V to +30V
OUT	-0.3V to ($V_{IN} + 0.3V$)
OVLO	-0.3V to +6V
Continuous IN Current	1A
Peak IN Current (Note 1)	5A
Continuous OVLO Current	50 μ A
Continuous Power Dissipation ($T_A = +70^\circ\text{C}$)	
8-Pin TDFN (derate 11.9mW/ $^\circ\text{C}$ above +70 $^\circ\text{C}$)	954mW

Package Junction-to-Ambient Thermal Resistance (θ_{JA}) (Note 2)	83.9 $^\circ\text{C}/\text{W}$
Package Junction-to-Case Thermal Resistance (θ_{JC}) (Note 2)	37 $^\circ\text{C}/\text{W}$
Operating Temperature Range	-40 $^\circ\text{C}$ to +85 $^\circ\text{C}$
Junction Temperature	+150 $^\circ\text{C}$
Storage Temperature Range	-65 $^\circ\text{C}$ to +150 $^\circ\text{C}$
Lead Temperature (soldering)	+300 $^\circ\text{C}$

Note 1: Limited by thermal shutdown.

Note 2: Package thermal resistances were obtained using the method described in JEDEC specification JESD51-7, using a four-layer board. For detailed information on package thermal considerations, refer to www.maxim-ic.com/thermal-tutorial.

Stresses beyond those listed under "Absolute Maximum Ratings" may cause permanent damage to the device. These are stress ratings only, and functional operation of the device at these or any other conditions beyond those indicated in the operational sections of the specifications is not implied. Exposure to absolute maximum rating conditions for extended periods may affect device reliability.

ELECTRICAL CHARACTERISTICS

($V_{IN} = +2.2V$ to +28V, $T_A = -40^\circ\text{C}$ to +85 $^\circ\text{C}$, unless otherwise noted. Typical values are at $V_{IN} = +5.0V$ and $T_A = +25^\circ\text{C}$.) (Note 3)

PARAMETER	SYMBOL	CONDITIONS	MIN	TYP	MAX	UNITS	
Input Voltage Range	V_{IN}		2.2		28	V	
Input Supply Current	I_{IN}	$V_{IN} < OVLO$		80	160	μA	
IN Overvoltage Trip Level	V_{IN_OVLO}	V_{IN} rising	MAX14527	5.6	5.75	5.9	V
			MAX14528	6.55	6.765	7	
		V_{IN} falling	MAX14527	5.54		5.84	
			MAX14528	6.5		6.95	
IN Overvoltage Lockout Hysteresis	$V_{IN_OVLO_HYS}$			1		%	
OVLO Set Threshold	V_{OVLO_THRESH}		1.2	1.245	1.29	V	
Adjustable OVLO Threshold Range			4		8	V	
External OVLO Select Threshold	V_{OVLO_SELECT}		0.15	0.33	0.5	V	
Switch On-Resistance	R_{ON}			100	200	m Ω	
OVLO Clamp		$I_{CLAMP} = 10\mu\text{A}$	3	4.56	5.5	V	
OUT Capacitor	C_{OUT}				1000	μF	
OVLO Input Leakage Current	I_{OVLO}	$V_{OVLO_THRESH} = 1.245V$	-100		+100	nA	
Thermal Shutdown				150		$^\circ\text{C}$	
Thermal Shutdown Hysteresis				20		$^\circ\text{C}$	

TIMING CHARACTERISTICS (Figure 1)

Debounce Time	t_{INDBC}	Time from $2.2V < V_{IN} < V_{IN_OVLO}$ to $V_{OUT} = 10\%$ of V_{IN}		15		ms
Switch Turn-On Time	t_{ON}	$2.2V < V_{IN} < V_{IN_OVLO}$, $R_{LOAD} = 100\Omega$, $C_{LOAD} = 100\mu\text{F}$; V_{OUT} from 10% to 90% of V_{IN}		0.7		ms
		$2.2V < V_{IN} < V_{IN_OVLO}$, $R_{LOAD} = 100\Omega$, $C_{LOAD} = 1\text{mF}$; V_{OUT} from 10% to 90% of V_{IN}		1.4		
Switch Turn-Off Time	t_{OFF}	$V_{IN} > V_{OVLO_THRESH}$ to $V_{OUT} = 80\%$ of V_{IN_OVLO} ; $R_{LOAD} = 1k\Omega$, V_{IN} rising at 2V/100ns		1.3	3.5	μs

Note 3: All specifications are 100% production tested at $T_A = +25^\circ\text{C}$, unless otherwise noted. Specifications are over -40 $^\circ\text{C}$ to +85 $^\circ\text{C}$ and are guaranteed by design.

Adjustable Overvoltage Protector with High Accuracy

Timing Diagram

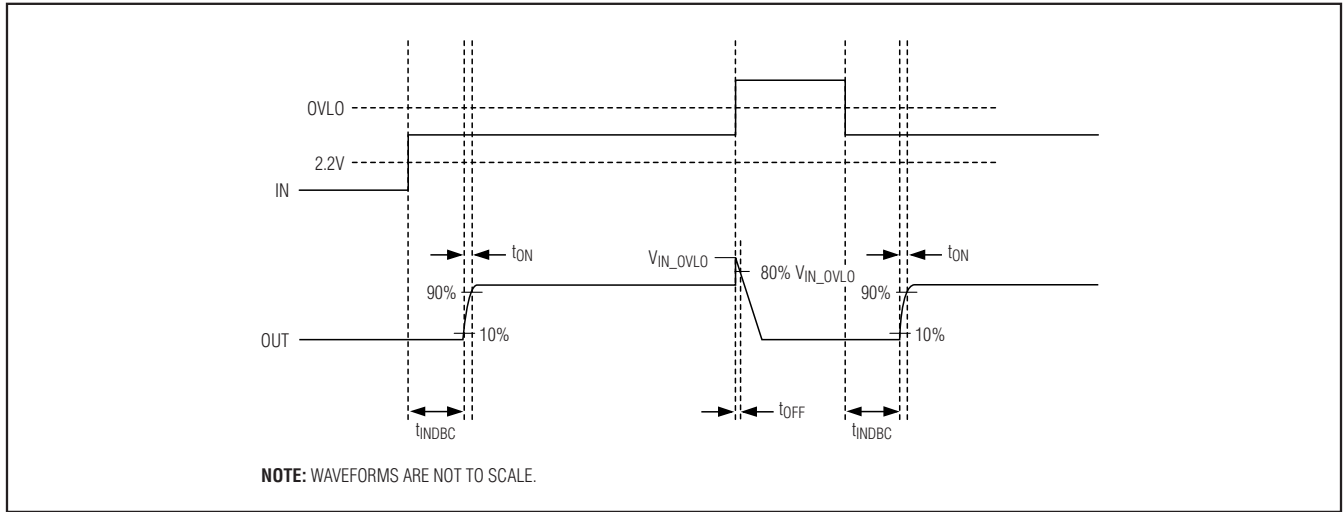

Figure 1. Timing Characteristics

MAX14527/MAX14528

[查询"MAX14528"供应商](#)

Adjustable Overvoltage Protector with High Accuracy

Typical Operating Characteristics

($T_A = +25^\circ\text{C}$, unless otherwise noted.)

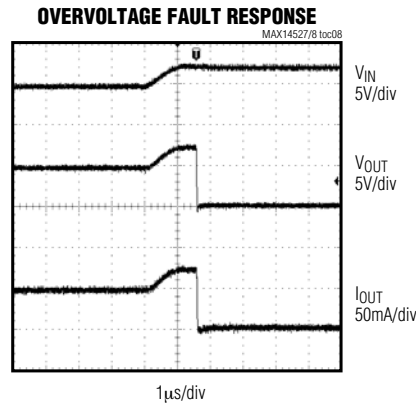
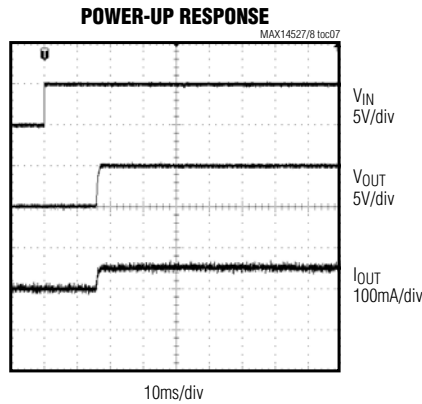
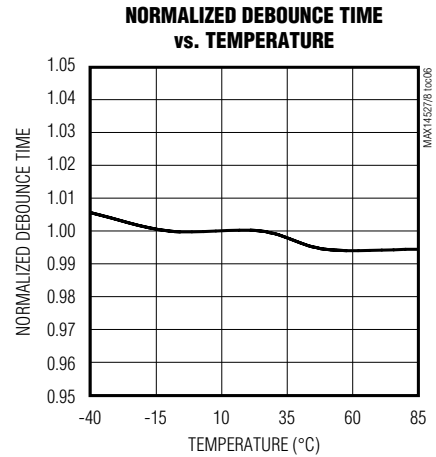
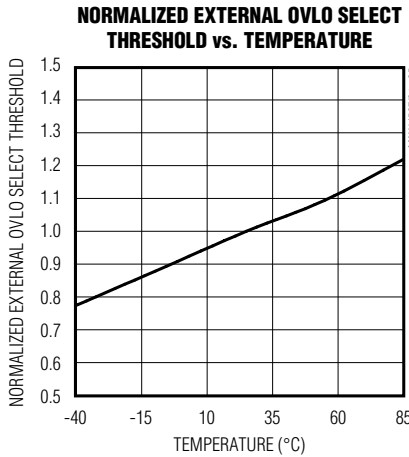
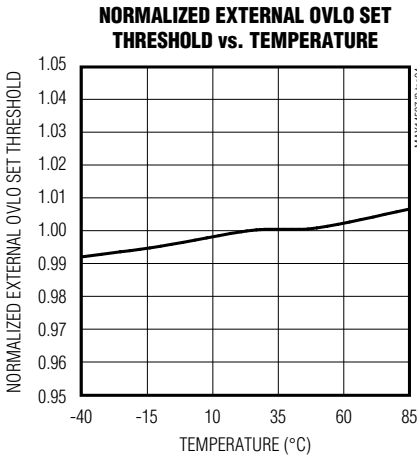
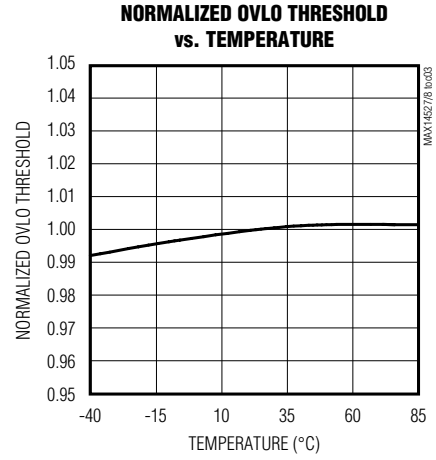
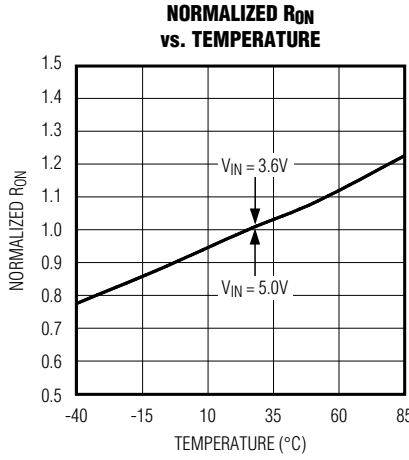
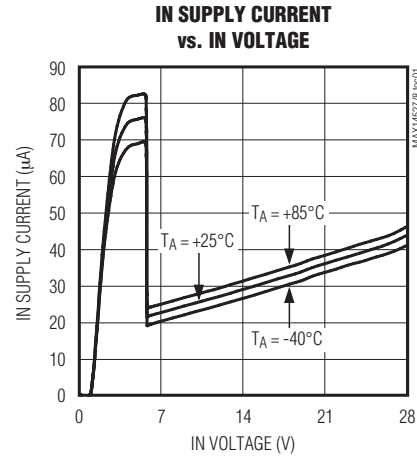

Adjustable Overvoltage Protector with High Accuracy

Pin Description

PIN	NAME	FUNCTION
1, 2	IN	Voltage Input. Bypass IN with a 1 μ F ceramic capacitor as close as possible to the device to obtain ± 15 kV Human Body Model (HBM) ESD protection. Connect all the IN pins together for proper operation. IN is protected to ± 2 kV HBM when IN is not bypassed with a capacitor to GND.
3	OVLO	External OVLO Adjustment. Connect OVLO to GND when using the internal threshold. Connect a resistor-divider to OVLO to set a different OVLO threshold; this external resistor-divider is completely independent from the internal threshold.
4, 5	I.C.	Internally Connected. Do not connect. Leave I.C. unconnected.
6	GND	Ground
7, 8	OUT	Output Voltage. Output of internal switch. Connect all the OUT outputs together for proper operation.
—	EP	Exposed Pad. Connect exposed pad to ground. For enhanced thermal dissipation, connect EP to a copper area as large as possible. Do not use EP as a sole ground connection.

Functional Diagram

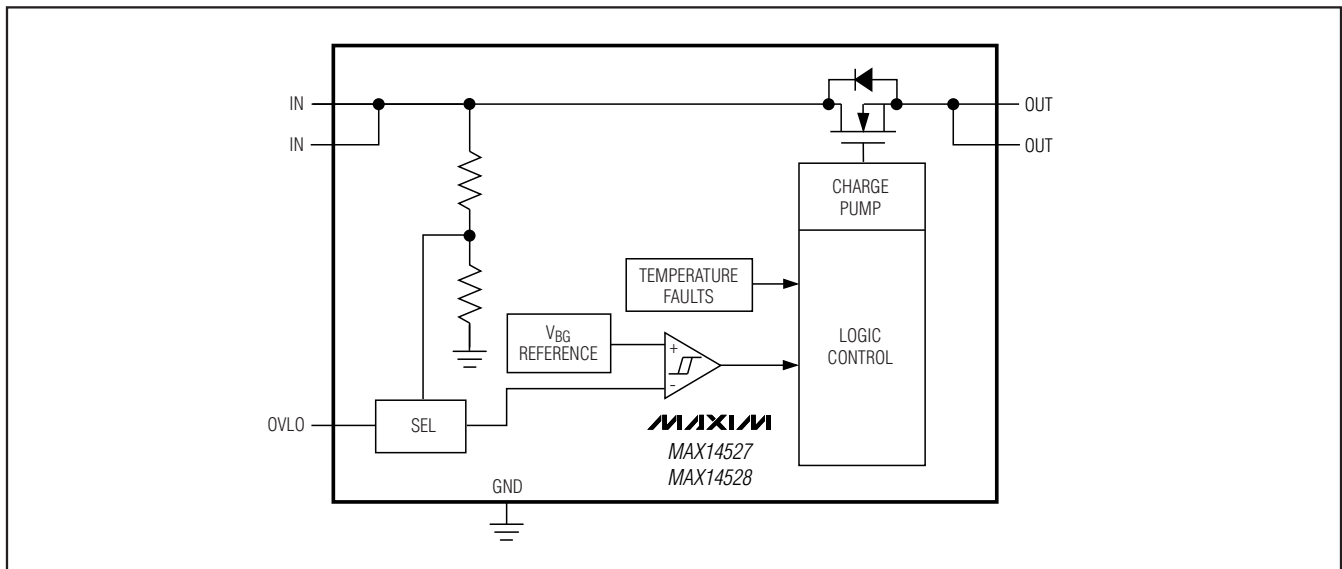

Detailed Description

The MAX14527/MAX14528 overvoltage protection devices feature a low R_{ON} internal FET and protect low-voltage systems against voltage faults up to +28V. If the input voltage exceeds the overvoltage threshold, the internal FET is turned off to prevent damage to the protected components. The 15ms debounce time prevents false turn-on of the internal FET during startup.

Device Operation

The MAX14527/MAX14528 have timing logic that controls the turn-on of the internal FET. If $V_{IN} < V_{OVLO_THRESH}$, the internal charge pump is enabled. The charge-pump startup, after a 15ms debounce delay, turns on the internal FET (see the *Functional Diagram*). At any time, if V_{IN} rises above V_{OVLO_THRESH} , OUT is disconnected from IN.

[查询"MAX14528"供应商](#)

Adjustable Overvoltage Protector with High Accuracy

Internal Switch

The MAX14527/MAX14528 incorporate an internal FET with a 100mΩ (typ) R_{ON}. The FET is internally driven by a charge pump that generates a necessary gate voltage above IN. The internal FET is capable of passing more than 5A inrush current.

Overvoltage Lockout (OVLO)

The MAX14527 has a 5.75V (typ) overvoltage threshold (OVLO). The MAX14528 has a 6.76V (typ) OVLO threshold.

Thermal-Shutdown Protection

The MAX14527/MAX14528 feature thermal shutdown circuitry. The internal FET turns off when the junction temperature exceeds +150°C (typ). The device exits thermal shutdown after the junction temperature cools by 20°C (typ).

Applications Information

IN Bypass Capacitor

For most applications, bypass IN to GND with a 1μF ceramic capacitor as close as possible to the device to enable ±15kV (HBM) ESD protection on IN. If ±15kV (HBM) ESD is not required, there is no capacitor required at IN. If the power source has significant inductance due to long lead length, take care to prevent overshoots due to the LC tank circuit and provide protection if necessary to prevent exceeding the +30V absolute maximum rating on IN.

OUT Output Capacitor

The slow turn-on time provides a soft-start function that allows the MAX14527/MAX14528 to charge an output capacitor up to 1000μF.

External OVLO Adjustment Functionality

If OVLO is connected to ground, the internal OVLO comparator uses the internally set OVLO value.

If an external resistor-divider is connected to OVLO and V_{OVLO} exceeds the OVLO select voltage, V_{OVLO_SELECT}, the internal OVLO comparator reads the IN fraction fixed by the external resistor divider. R₁ = 1MΩ is a good starting value for minimum current consumption. Since V_{IN_OVLO}, V_{OVLO_THRESH}, and R₁ are known, R₂ can be calculated from the following formula:

$$V_{IN_OVLO} = V_{OVLO_THRESH} \times \left[1 + \frac{R_1}{R_2} \right]$$

This external resistor-divider is completely independent from the internal resistor-divider.

ESD Test Conditions

ESD performance depends on a number of conditions.

The MAX14527/MAX14528 are specified for ±15kV (HBM) typical ESD resistance on IN when IN is bypassed to ground with a 1μF ceramic capacitor.

HBM ESD Protection

Figure 2a shows the Human Body Model, and Figure 2b shows the current waveform it generates when discharged into a low impedance. This model consists of a 100pF capacitor charged to the ESD voltage of interest, which is then discharged into the device through a 1.5kΩ resistor.

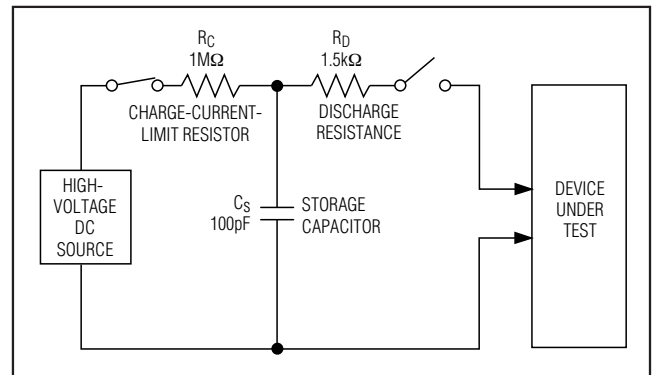

Figure 2a. Human Body ESD Test Model

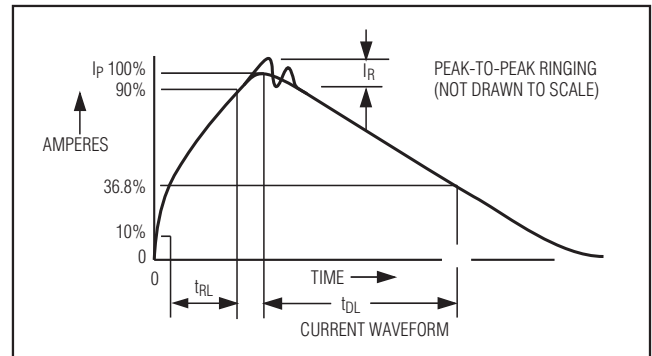
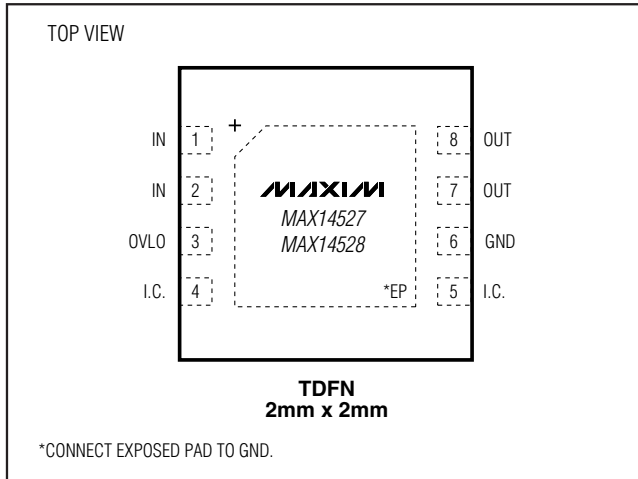

Figure 2b. Human Body Current Waveform

Adjustable Overvoltage Protector with High Accuracy

MAX14527/MAX14528

Pin Configuration



PROCESS: BiCMOS

Chip Information

Package Information

For the latest package outline information and land patterns, go to www.maxim-ic.com/packages.

PACKAGE TYPE	PACKAGE CODE	DOCUMENT NO.
8 TDFN-EP	T822+2	21-0168

Maxim cannot assume responsibility for use of any circuitry other than circuitry entirely embodied in a Maxim product. No circuit patent licenses are implied. Maxim reserves the right to change the circuitry and specifications without notice at any time.

Maxim Integrated Products, 120 San Gabriel Drive, Sunnyvale, CA 94086 408-737-7600 _____ 7