

## 2SA781 (K)

SILICON PNP EPITAXIAL  
HIGH FREQUENCY AMPLIFIER  
HIGH SPEED SWITCHING

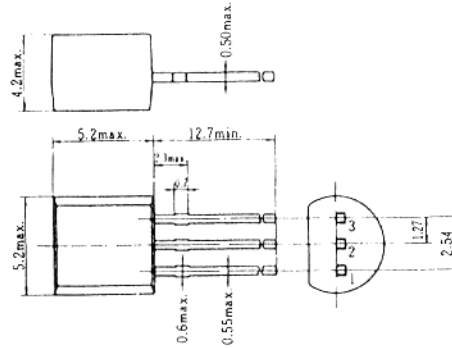

(JEDEC TO-92)

1. Emitter
  2. Collector
  3. Base
- (Dimensions in mm)

### ■ ABSOLUTE MAXIMUM RATINGS (Ta=25°C)

Item	Symbol	2SA781 (K)	Unit
Collector to base voltage	V <sub>CB0</sub>	-20	V
Collector to emitter voltage	V <sub>CEO</sub>	-15	V
Emitter to base voltage	V <sub>EBO</sub>	-4	V
Collector current	I <sub>c</sub>	-200	mA
Collector power dissipation	P <sub>c</sub>	200	mW
Junction temperature	T <sub>j</sub>	150	°C
Storage temperature	T <sub>sig</sub>	-55 to +150	°C

### MAXIMUM COLLECTOR DISSIPATION CURVE

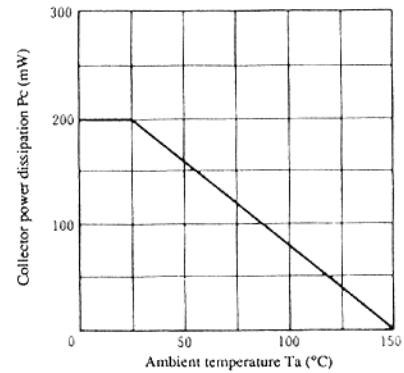

### ■ ELECTRICAL CHARACTERISTICS (Ta=25°C)

Item	Symbol	Test Condition	min.	typ.	max.	Unit
Collector to base breakdown voltage	V <sub>(BR)CBO</sub>	I <sub>c</sub> = -10μA, I <sub>E</sub> = 0	-20	—	—	V
Collector to emitter breakdown voltage	V <sub>(BR)CEO</sub>	I <sub>c</sub> = -10mA, R <sub>BE</sub> = ∞	-15	—	—	V
Emitter to base breakdown voltage	V <sub>(BR)EBO</sub>	I <sub>E</sub> = -100μA, I <sub>c</sub> = 0	-4	—	—	V
Collector cutoff current	I <sub>CBO</sub>	V <sub>CB</sub> = -16V, I <sub>E</sub> = 0	—	—	-0.2	μA
Emitter cutoff current	I <sub>EBO</sub>	V <sub>EB</sub> = -2V, I <sub>c</sub> = 0	—	—	-0.2	μA
DC current transfer ratio	h <sub>FE</sub>	V <sub>CE</sub> = -0.5V, I <sub>c</sub> = -30mA	20	—	200	
Base to emitter saturation voltage	V <sub>BE(sat)</sub>	I <sub>c</sub> = -30mA, I <sub>B</sub> = -1mA	—	—	-1.0	V
Collector to emitter saturation voltage	V <sub>CE(sat)</sub>	I <sub>c</sub> = -30mA, I <sub>B</sub> = -1mA	—	—	-0.5	V
Gain bandwidth product	f <sub>r</sub>	V <sub>CE</sub> = -1V, I <sub>c</sub> = -30mA	—	550	—	MHz
Turn on time	t <sub>on</sub>	V <sub>CC</sub> = -5V, I <sub>B1</sub> = -2mA I <sub>c</sub> = -30mA, I <sub>B2</sub> = 0	—	—	70	ns
Turn off time	t <sub>off</sub>	V <sub>CC</sub> = -5V, I <sub>B1</sub> = -2.7mA I <sub>c</sub> = -30mA, I <sub>B2</sub> = 0	—	—	120	μs

### SWITCHING TIME TEST CIRCUIT

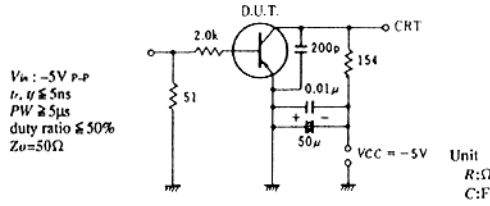

### SWITCHING TIME TEST CIRCUIT

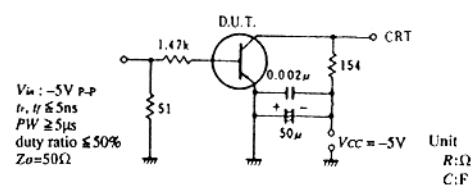

### RESPONSE WAVEFORM

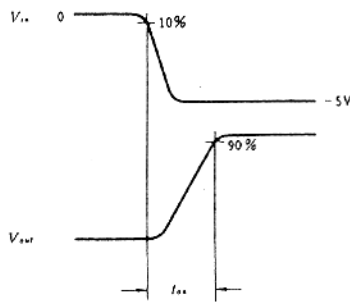

### RESPONSE WAVEFORM

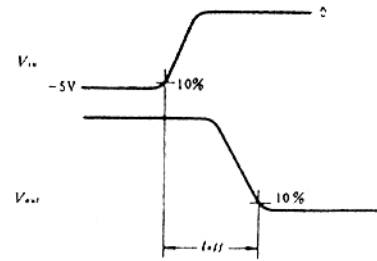

### TYPICAL OUTPUT CHARACTERISTICS (1)

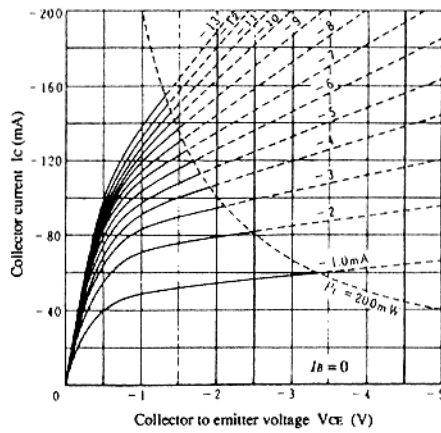

### TYPICAL OUTPUT CHARACTERISTICS (2)

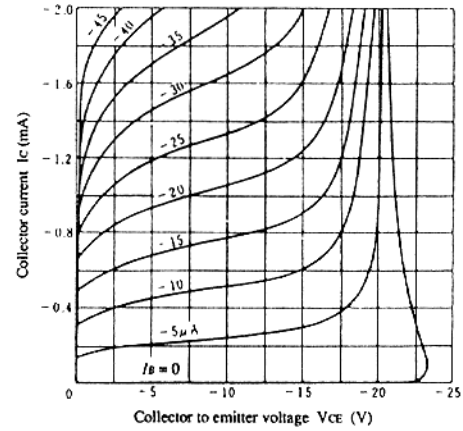

## 2SA781(K)

TYPICAL TRANSFER CHARACTERISTICS

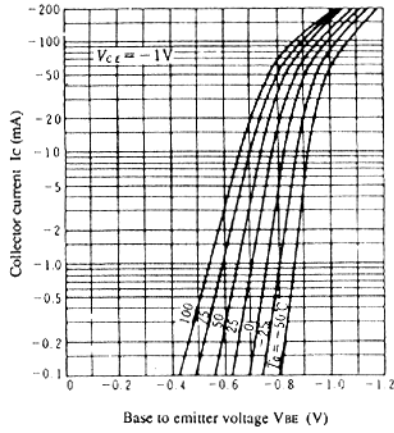

DC CURRENT TRANSFER RATIO VS. COLLECTOR CURRENT

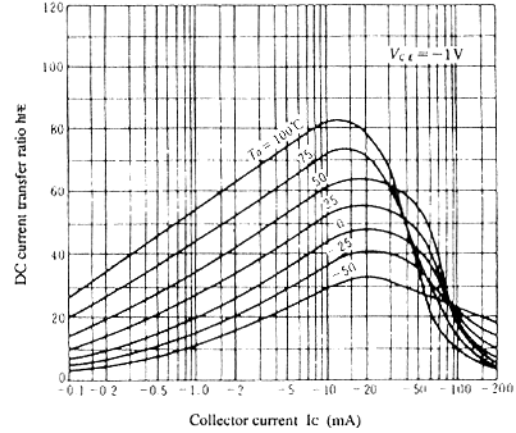

COLLECTOR TO EMITTER SATURATION VOLTAGE VS. BASE CURRENT

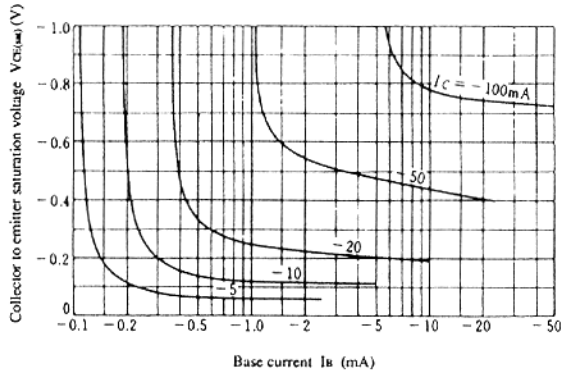

COLLECTOR TO EMITTER SATURATION VOLTAGE VS. COLLECTOR CURRENT

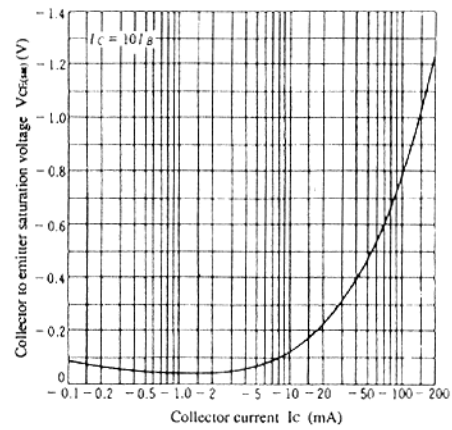

BASE TO EMITTER SATURATION VOLTAGE VS. COLLECTOR CURRENT

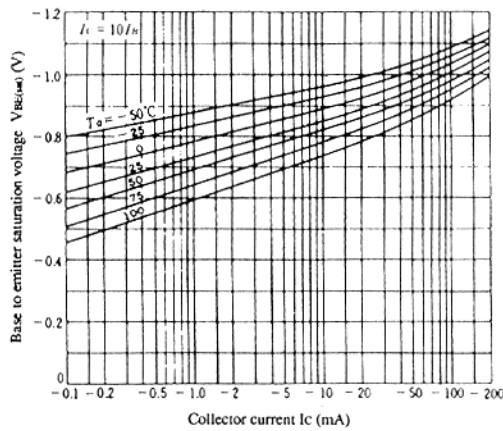

GAIN BANDWIDTH PRODUCT VS. COLLECTOR CURRENT

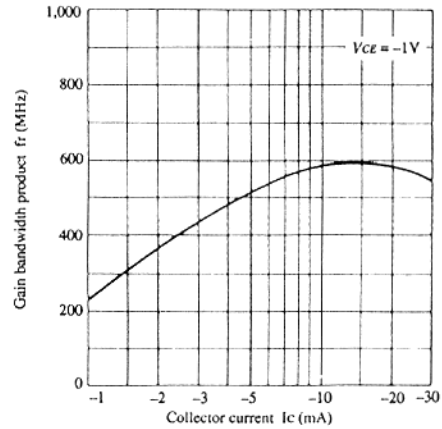

**EMITTER INPUT CAPACITANCE VS. EMITTER TO BASE VOLTAGE**

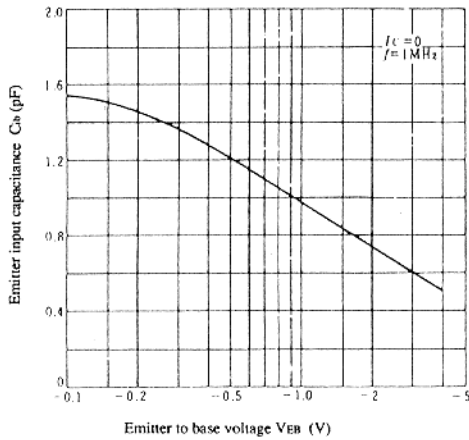

**COLLECTOR OUTPUT CAPACITANCE VS. COLLECTOR TO BASE VOLTAGE**

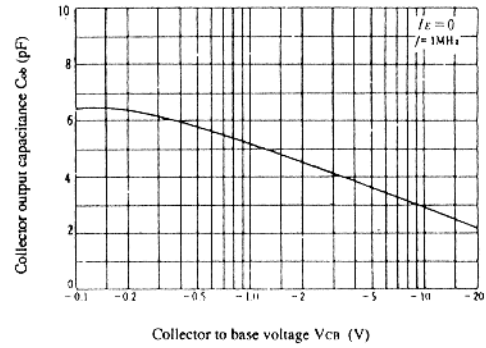

**COLLECTOR CUTOFF CURRENT VS. COLLECTOR TO BASE VOLTAGE**

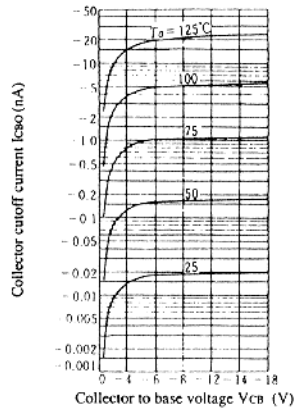

**SWITCHING TIME VS. COLLECTOR CURRENT**

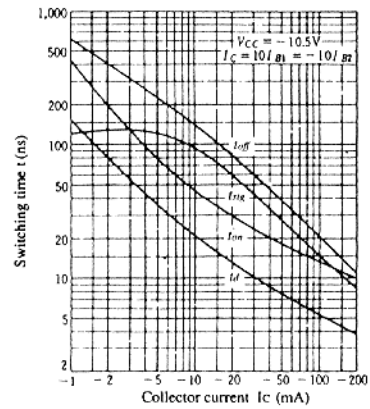

**SWITCHING TIME TEST CIRCUIT**

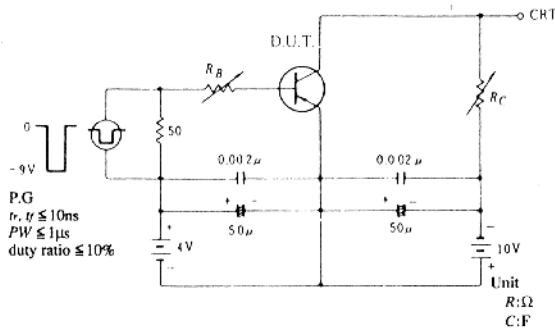

**RESPONSE WAVEFORM**

