

$V_{DSM} = 4200 \text{ V}$   
 $I_{TAVM} = 1150 \text{ A}$   
 $I_{TRMS} = 1800 \text{ A}$   
 $I_{TSM} = 15000 \text{ A}$   
 $V_{T0} = 0.95 \text{ V}$   
 $r_T = 0.575 \text{ m}\Omega$

# Phase Control Thyristor

## 5STP 12F4200

Doc. No. 5SYA1021-03 Jan. 02

- Patented free-floating silicon technology
- Low on-state and switching losses
- Designed for traction, energy and industrial applications
- Optimum power handling capability

### Blocking

Maximum rated values <sup>1)</sup>

| Symbol             | Conditions  | 5STP 12F4200          | 5STP 12F4000 | 5STP 12F3600 |
|--------------------|---|-----------------------|--------------|--------------|
| $V_{DRM}, V_{RRM}$ | $f = 50 \text{ Hz}, t_p = 10 \text{ ms}$                  | 4200 V                | 4000 V       | 3600 V       |
| $V_{RSM}$          | $t_p = 5 \text{ ms}, \text{ single pulse}$                | 4600 V                | 4400 V       | 4000 V       |
| $dV/dt_{crit}$     | Exp. to $0.67 \times V_{DRM}, T_{vj} = 125^\circ\text{C}$ | 1000 V/ $\mu\text{s}$ |              |              |

Characteristic values

| Parameter               | Symbol    | Conditions                            | min | typ | max | Unit |
|-------------------------|-----------|---------------------------------------|-----|-----|-----|------|
| Forward leakage current | $I_{DRM}$ | $V_{DRM}, T_{vj} = 125^\circ\text{C}$ |     |     | 200 | mA   |
| Reverse leakage current | $I_{RRM}$ | $V_{RRM}, T_{vj} = 125^\circ\text{C}$ |     |     | 200 | mA   |

### Mechanical data

Maximum rated values <sup>1)</sup>

| Parameter      | Symbol | Conditions       | min | typ | max | Unit           |
|----------------|--------|------------------|-----|-----|-----|----------------|
| Mounting force | $F_M$  |                  | 14  | 22  | 24  | kN             |
| Acceleration   | $a$    | Device unclamped |     |     | 50  | $\text{m/s}^2$ |
| Acceleration   | $a$    | Device clamped   |     |     | 100 | $\text{m/s}^2$ |

Characteristic values

| Parameter                 | Symbol | Conditions | min | typ | max | Unit |
|---------------------------|--------|------------|-----|-----|-----|------|
| Weight                    | $m$    |            |     | 0.6 |     | kg   |
| Surface creepage distance | $D_s$  |            | 25  |     |     | mm   |
| Air strike distance       | $D_a$  |            | 14  |     |     | mm   |

<sup>1)</sup> Maximum ratings are those values beyond which damage to the device may occur

ABB Switzerland Ltd, Semiconductors reserves the right to change specifications without notice.

## On-state

Maximum rated values <sup>1)</sup> 供应商

| Parameter                         | Symbol     | Conditions   | min | typ | max   | Unit                  |
|-----------------------------------|------------|--|-----|-----|-------|-----------------------|
| Average on-state current          | $I_{TAVM}$ | Half sine wave, $T_c = 70^\circ\text{C}$   |     |     | 1150  | A                     |
| RMS on-state current              | $I_{TRMS}$ |  |     |     | 1800  | A                     |
| Peak non-repetitive surge current | $I_{TSM}$  | $t_p = 10\text{ ms}$ , $T_{vj} = 125^\circ\text{C}$ ,<br>$V_D = V_R = 0\text{ V}$  |     |     | 15000 | A                     |
| Limiting load integral            | $I^2t$     |  |     |     | 1125  | $\text{kA}^2\text{s}$ |
| Peak non-repetitive surge current | $I_{TSM}$  | $t_p = 8.3\text{ ms}$ , $T_{vj} = 125^\circ\text{C}$ ,<br>$V_D = V_R = 0\text{ V}$ |     |     | 16000 | A                     |
| Limiting load integral            | $I^2t$     |  |     |     | 1062  | $\text{kA}^2\text{s}$ |

### Characteristic values

| Parameter         | Symbol   | Conditions  | min | typ | max   | Unit             |
|-------------------|----------|---|-----|-----|-------|------------------|
| On-state voltage  | $V_T$    | $I_T = 2000\text{ A}$ , $T_{vj} = 125^\circ\text{C}$                |     |     | 2.1   | V                |
| Threshold voltage | $V_{T0}$ | $I_T = 600\text{ A} - 1800\text{ A}$ , $T_{vj} = 125^\circ\text{C}$ |     |     | 0.95  | V                |
| Slope resistance  | $r_T$    |   |     |     | 0.575 | $\text{m}\Omega$ |
| Holding current   | $I_H$    | $T_{vj} = 25^\circ\text{C}$   |     |     | 80    | mA               |
|                   |          | $T_{vj} = 125^\circ\text{C}$  |     |     | 60    | mA               |
| Latching current  | $I_L$    | $T_{vj} = 25^\circ\text{C}$   |     |     | 500   | mA               |
|                   |          | $T_{vj} = 125^\circ\text{C}$  |     |     | 200   | mA               |

## Switching

Maximum rated values <sup>1)</sup>

| Parameter                                 | Symbol         | Conditions  | min                         | typ | max | Unit                   |
|---|----------------|---|-----------------------------|-----|-----|------------------------|
| Critical rate of rise of on-state current | $di/dt_{crit}$ | $T_{vj} = 125^\circ\text{C}$ , $I_{TRM} = 2000\text{ A}$ ,<br>$V_D \leq 0.67 \cdot V_{DRM}$ ,<br>$I_{FG} = 2\text{ A}$ , $t_r = 0.5\text{ }\mu\text{s}$   |                             |     | 100 | $\text{A}/\mu\text{s}$ |
| Critical rate of rise of on-state current | $di/dt_{crit}$ |   | Cont.<br>$f = 50\text{ Hz}$ |     |     | 1000                   |
| Circuit-commutated turn-off time          | $t_q$          | $T_{vj} = 125^\circ\text{C}$ , $I_{TRM} = 2000\text{ A}$ ,<br>$V_R = 200\text{ V}$ , $di_T/dt = -5\text{ A}/\mu\text{s}$ ,<br>$V_D \leq 0.67 \cdot V_{DRM}$ , $dV_D/dt = 20\text{ V}/\mu\text{s}$ , | 600                         |     |     | $\mu\text{s}$          |

### Characteristic values

| Parameter       | Symbol   | Conditions   | min  | typ | max  | Unit           |
|-----------------|----------|--|------|-----|------|----------------|
| Recovery charge | $Q_{rr}$ | $T_{vj} = 125^\circ\text{C}$ , $I_{TRM} = 2000\text{ A}$ ,<br>$V_R = 200\text{ V}$ , $di_T/dt = -5\text{ A}/\mu\text{s}$ | 2500 |     | 4000 | $\mu\text{As}$ |
| Delay time      | $t_d$    | $V_D = 0.4 \cdot V_{DRM}$ , $I_{FG} = 2\text{ A}$ , $t_r = 0.5\text{ }\mu\text{s}$                                       |      |     | 2    | $\mu\text{s}$  |

# Triggering

Maximum rated values <sup>1)</sup>

| Parameter                 | Symbol           | Conditions          | min        | typ | max | Unit |
|---------------------------|------------------|---------------------|------------|-----|-----|------|
| Peak forward gate voltage | V <sub>FGM</sub> |                     |            |     | 12  | V    |
| Peak forward gate current | I <sub>FGM</sub> |                     |            |     | 10  | A    |
| Peak reverse gate voltage | V <sub>RGM</sub> |                     |            |     | 10  | V    |
| Gate power loss           | P <sub>G</sub>   | For DC gate current |            |     | 3   | W    |
| Average gate power loss   | P <sub>GAV</sub> |                     | see Fig. 9 |     |     |      |

## Characteristic values

| Parameter                | Symbol          | Conditions   | min | typ | max | Unit |
|--------------------------|-----------------|--|-----|-----|-----|------|
| Gate trigger voltage     | V <sub>GT</sub> | T <sub>vj</sub> = 25°C   |     |     | 2.6 | V    |
| Gate trigger current     | I <sub>GT</sub> | T <sub>vj</sub> = 25°C   |     |     | 400 | mA   |
| Gate non-trigger voltage | V <sub>GD</sub> | V <sub>D</sub> = 0.4 x V <sub>DRM</sub> , T <sub>vjmax</sub> = 125°C | 0.3 |     |     | V    |
| Gate non-trigger current | I <sub>GD</sub> | V <sub>D</sub> = 0.4 x V <sub>DRM</sub> , T <sub>vjmax</sub> = 125°C | 10  |     |     | mA   |

# Thermal

Maximum rated values <sup>1)</sup>

| Parameter                            | Symbol           | Conditions | min | typ | max | Unit |
|--------------------------------------|------------------|------------|-----|-----|-----|------|
| Operating junction temperature range | T <sub>vj</sub>  |            |     |     | 125 | °C   |
| Storage temperature range            | T <sub>stg</sub> |            | -40 |     | 140 | °C   |

## Characteristic values

| Parameter                           | Symbol                | Conditions          | min | typ | max | Unit |
|-------------------------------------|-----------------------|---------------------|-----|-----|-----|------|
| Thermal resistance junction to case | R <sub>th(j-c)</sub>  | Double-side cooled  |     |     | 17  | K/kW |
|                                     | R <sub>th(j-c)A</sub> | Anode-side cooled   |     |     | 33  | K/kW |
|                                     | R <sub>th(j-c)C</sub> | Cathode-side cooled |     |     | 35  | K/kW |
| Thermal resistance case to heatsink | R <sub>th(c-h)</sub>  | Double-side cooled  |     |     | 4   | K/kW |
|                                     | R <sub>th(c-h)</sub>  | Single-side cooled  |     |     | 8   | K/kW |

Analytical function for transient thermal impedance:

$$Z_{thJC}(t) = \sum_{i=1}^n R_i(1 - e^{-t/\tau_i})$$

| i                     | 1      | 2      | 3      | 4      |
|-----------------------|--------|--------|--------|--------|
| R <sub>i</sub> (K/kW) | 10.35  | 3.76   | 2.29   | 0.67   |
| τ <sub>i</sub> (s)    | 0.3723 | 0.0525 | 0.0057 | 0.0023 |

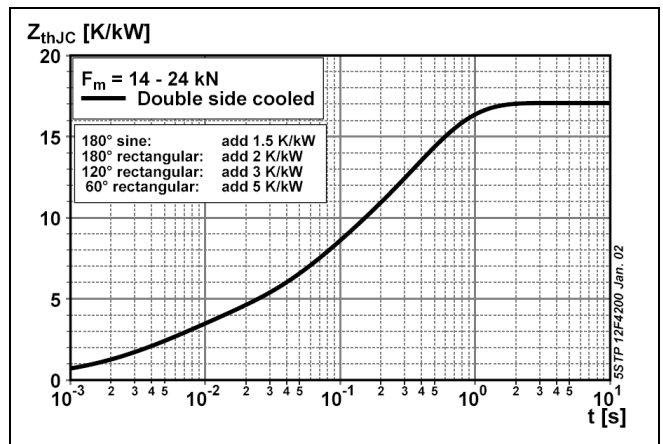

Fig. 1 Transient thermal impedance junction-to case.

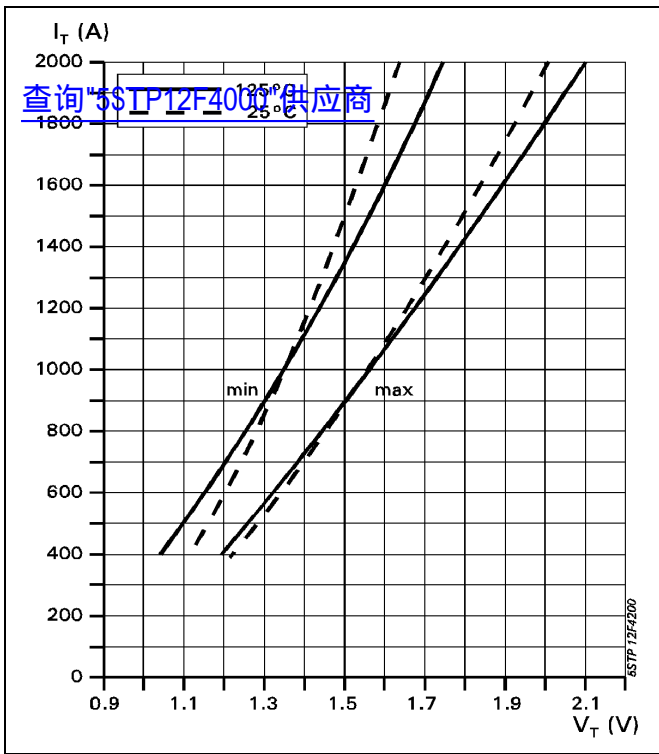

Fig. 2 On-state characteristics.

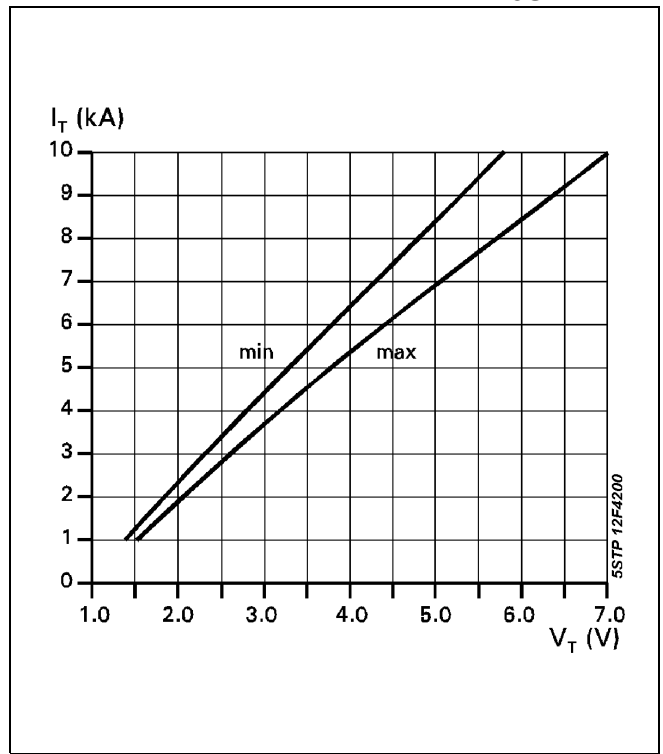

Fig. 3 On-state characteristics.  
 $T_j=125^\circ\text{C}$ , 10ms half sine

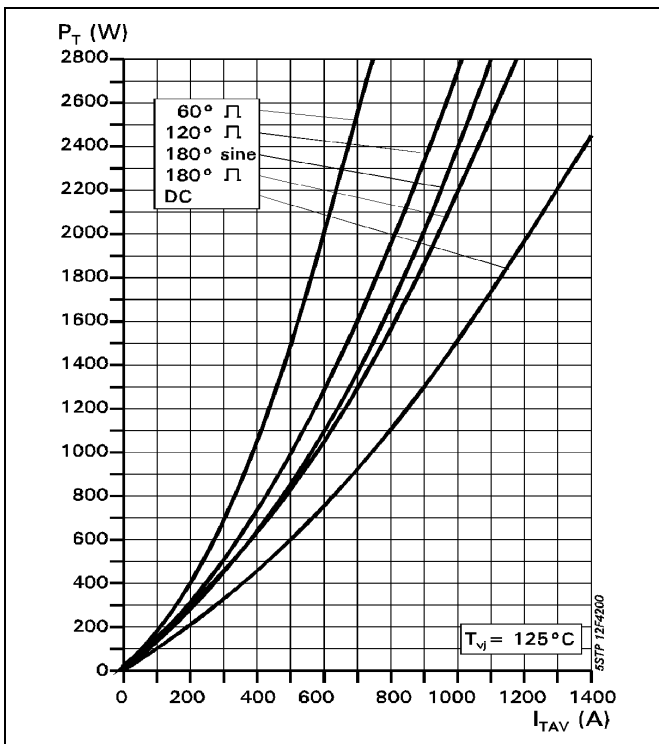

Fig. 4 On-state power dissipation vs. mean on-state current. Turn - on losses excluded.

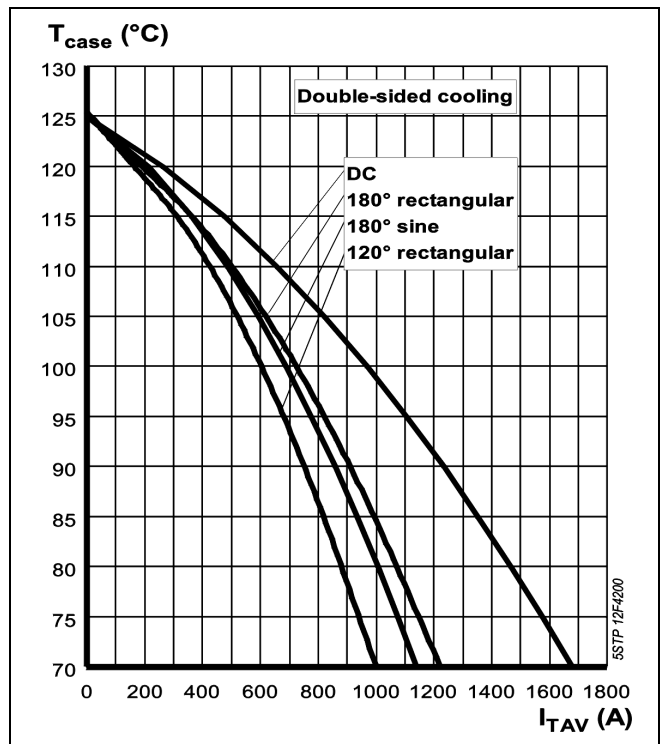

Fig. 5 Max. permissible case temperature vs. mean on-state current.

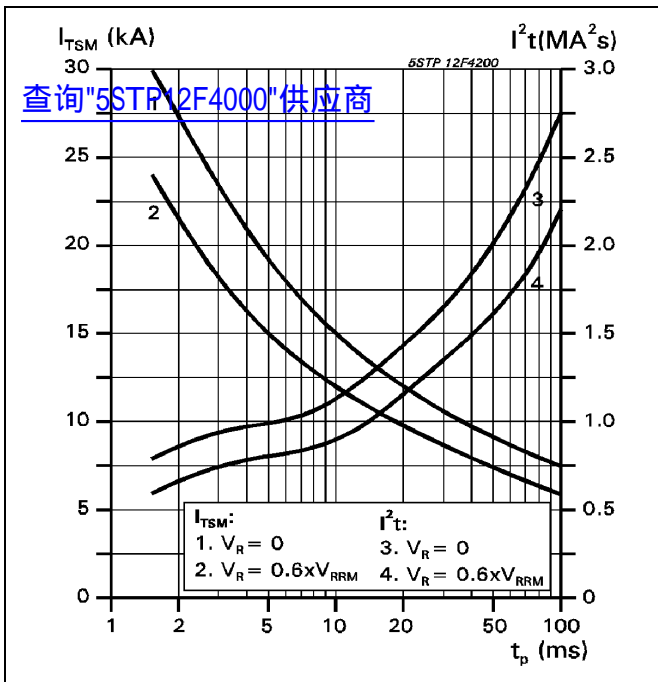

Fig. 6 Surge on-state current vs. pulse length. Half-sine wave.

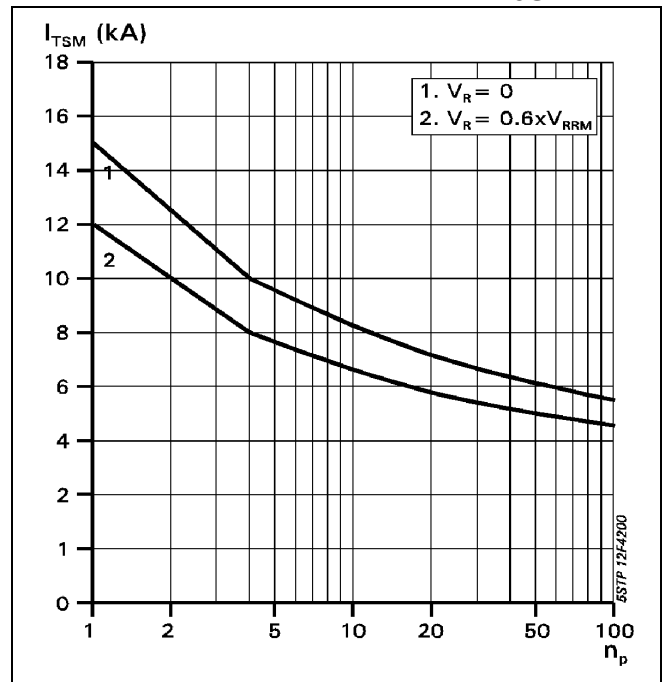

Fig. 7 Surge on-state current vs. number of pulses. Half-sine wave, 10 ms, 50Hz.

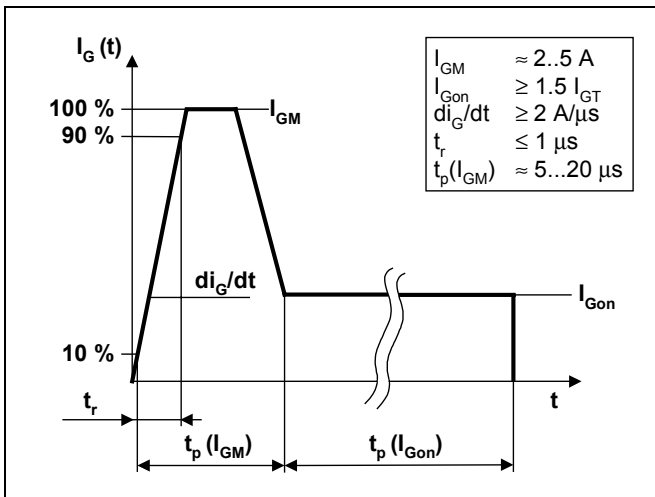

Fig. 8 Recommended gate current waveform.

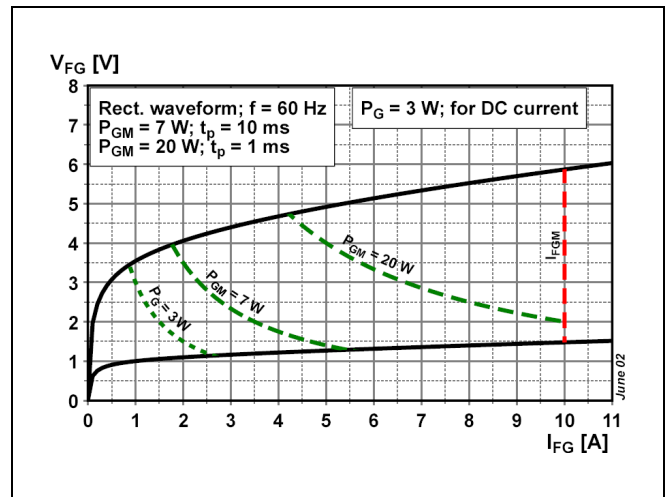

Fig. 9 Max. peak gate power loss.

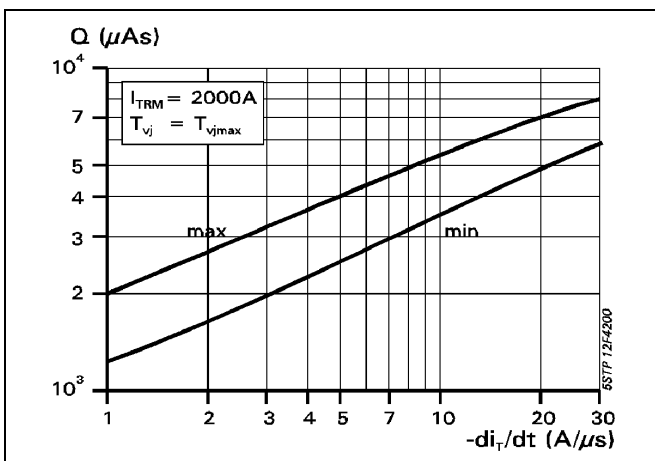

Fig. 10 Recovery charge vs. decay rate of on-state current.

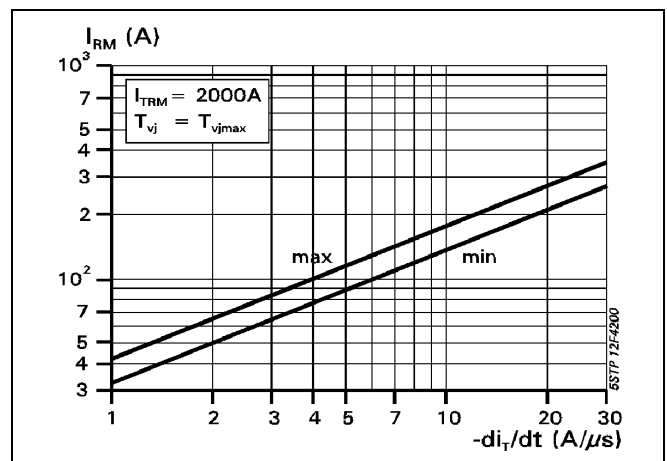

Fig. 11 Peak reverse recovery current vs. decay rate of on-state current.

[查询"5STP12F4000"供应商](#)

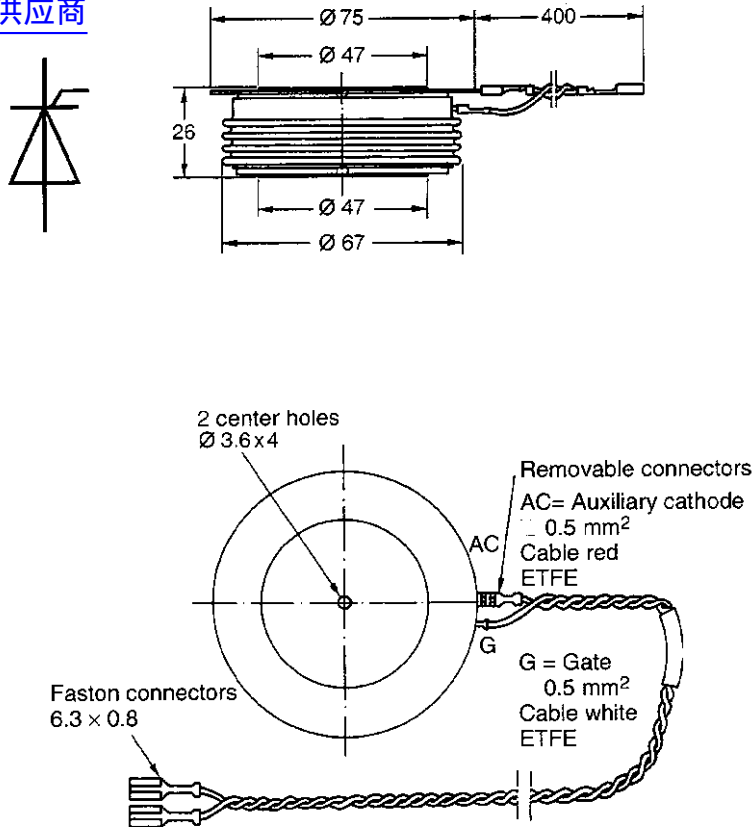

Fig. 12 Device Outline Drawing.

ABB Switzerland Ltd, Semiconductors reserves the right to change specifications without notice.

**ABB**

ABB Switzerland Ltd  
 Semiconductors  
 Fabrikstrasse 3  
 CH-5600 Lenzburg, Switzerland

Telephone +41 (0)58 586 1419  
 Fax +41 (0)58 586 1306  
 Email [abbsem@ch.abb.com](mailto:abbsem@ch.abb.com)  
 Internet [www.abbsem.com](http://www.abbsem.com)

Doc. No. 5SYA1021-03 Jan. 02