

Low Vcesat PNP Epitaxial Planar Transistor

BTB1412J3

Features

- Low $V_{CE(sat)}$, $V_{CE(sat)} = -0.6\text{ V}$ (typical), at $I_C / I_B = -4\text{ A} / -0.1\text{ A}$
- Excellent DC current gain characteristics
- Complementary to BTB2118J3

Symbol

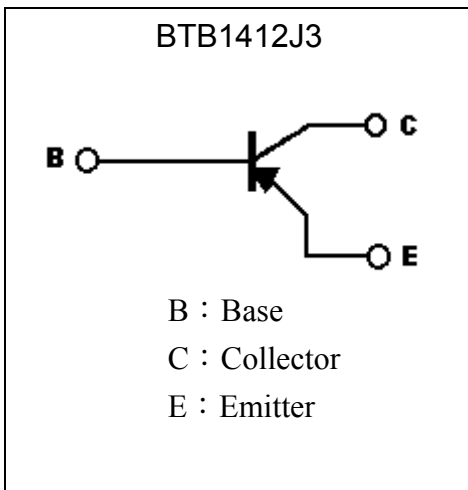

Outline

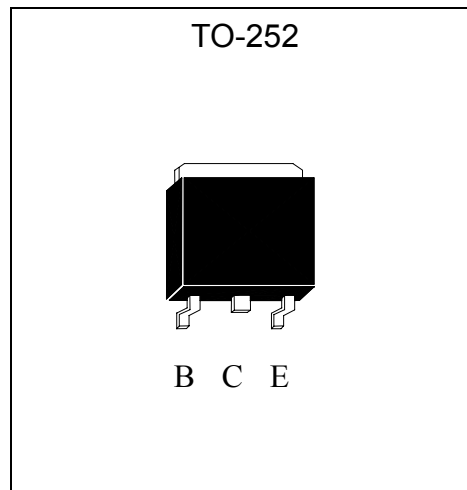

Absolute Maximum Ratings ($T_a = 25^\circ\text{C}$)

Parameter	Symbol	Limits	Unit
Collector-Base Voltage	V_{CBO}	-20	V
Collector-Emitter Voltage	V_{CEO}	-15	V
Emitter-Base Voltage	V_{EBO}	-6	V
Collector Current	$I_C(\text{DC})$	-5	A
	$I_C(\text{Pulse})$	-10 *1	
Power Dissipation	$P_d(T_a = 25^\circ\text{C})$	1	W
	$P_d(T_c = 25^\circ\text{C})$	10	
Junction Temperature	T_j	150	$^\circ\text{C}$
Storage Temperature	T_{stg}	-55~+150	$^\circ\text{C}$

Note : *1. Single Pulse $P_w = 10\text{ms}$

Characteristics (Ta=25°C)

Symbol	Min.	Typ.	Max.	Unit	Test Conditions
BV _{CBO}	-20	-	-	V	I _C =-50μA, I _E =0
BV _{CEO}	-15	-	-	V	I _C =-1mA, I _B =0
BV _{EBO}	-6	-	-	V	I _E =-50μA, I _C =0
I _{CBO}	-	-	-0.5	μA	V _{CB} =-15V, I _E =0
I _{EBO}	-	-	-0.5	μA	V _{EB} =-5V, I _C =0
*V _{CE(sat)}	-	-	-1.0	V	I _C =-4A, I _B =-0.1A
*h _{FE}	120	-	560	-	V _{CE} =-2V, I _C =-0.5A
f _T	-	120	-	MHz	V _{CE} =-6V, I _C =-50mA, f=30MHz
C _{ob}	-	60	-	pF	V _{CB} =-20V, f=1MHz

*Pulse Test : Pulse Width ≤380μs, Duty Cycle≤2%

Classification Of h_{FE}

Rank	Q	R	S
Range	120~270	180~390	270~560

Characteristic Curves

Current Gain vs Collector Current

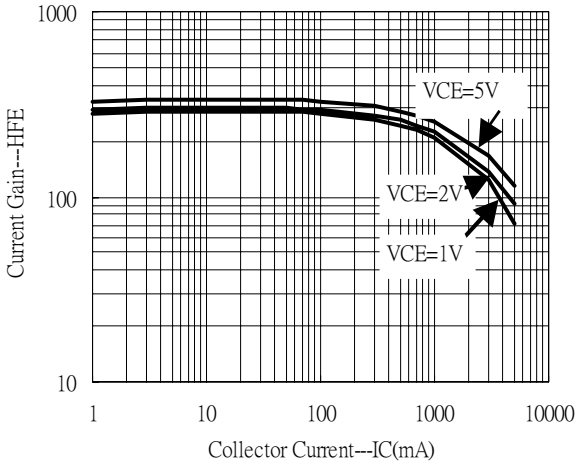

Saturation Voltage vs Collector Current

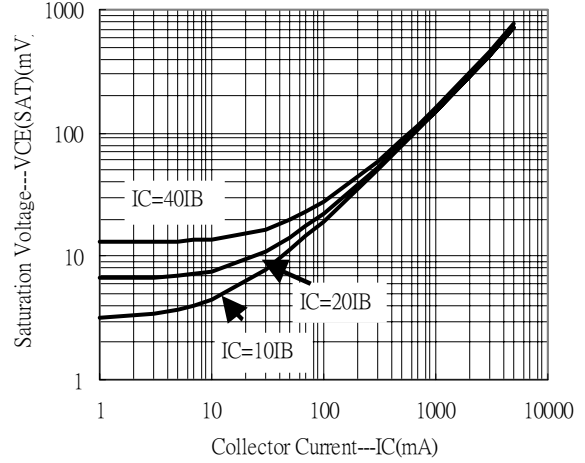

Saturation Voltage vs Collector Current

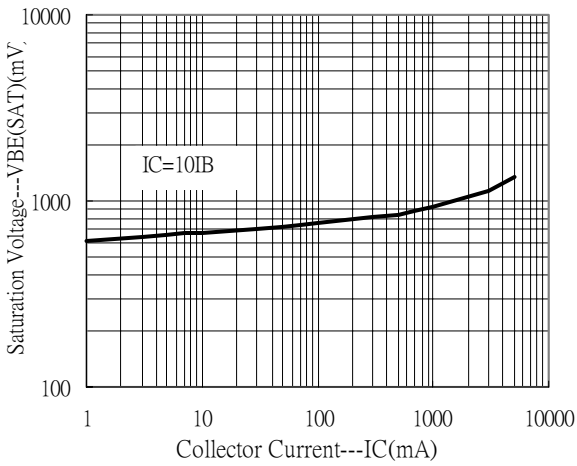

Power Derating Curve

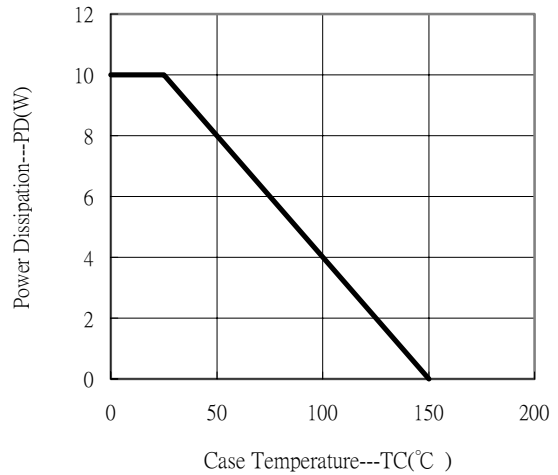

Power Derating Curve

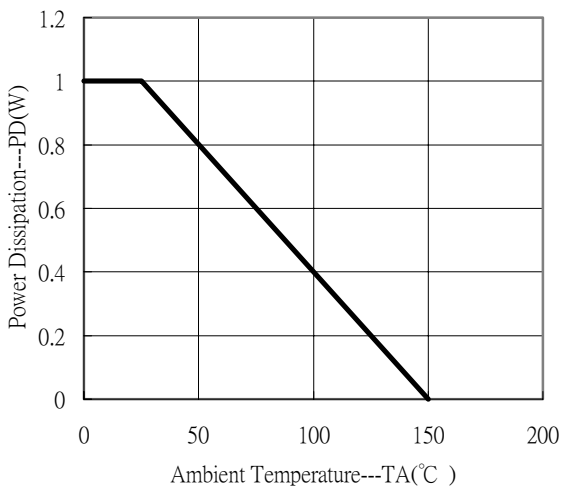

TO-252 Dimension

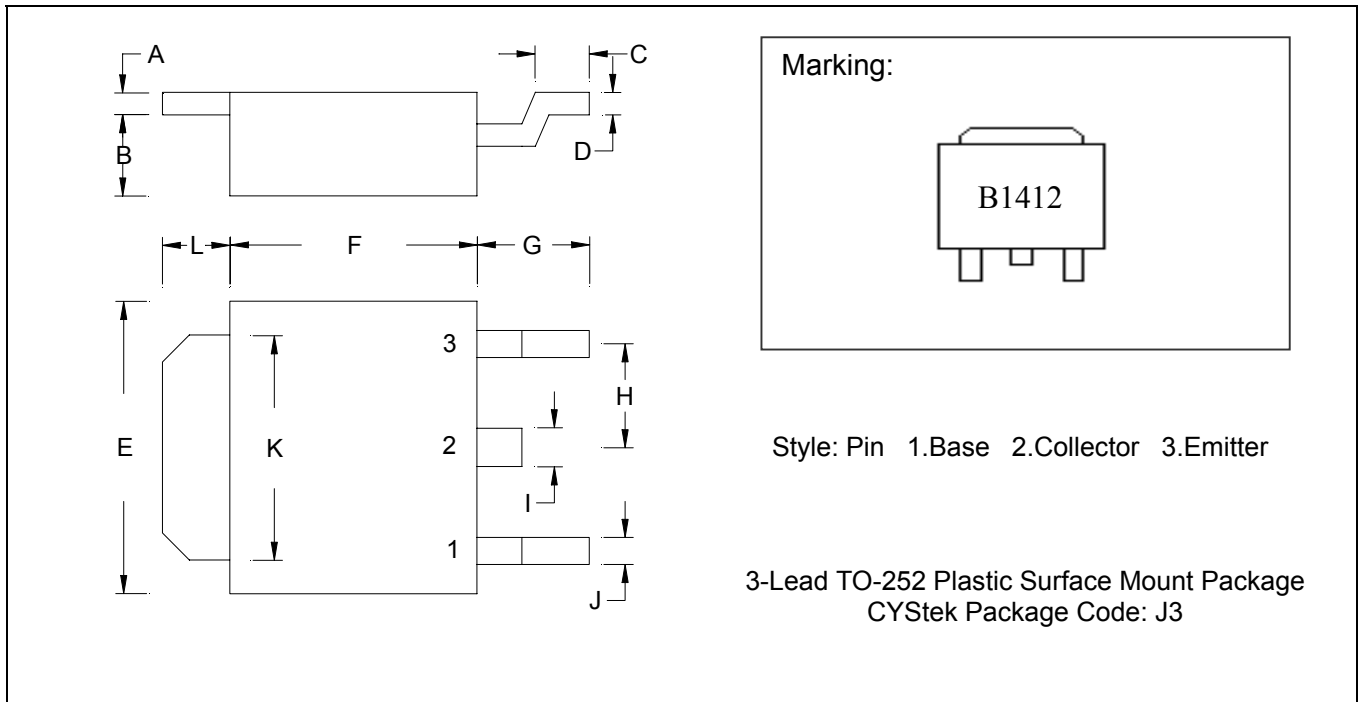

*: Typical

DIM	Inches		Millimeters		DIM	Inches		Millimeters	
	Min.	Max.	Min.	Max.		Min.	Max.	Min.	Max.
A	0.0177	0.0217	0.45	0.55	G	0.0866	0.1102	2.20	2.80
B	0.0650	0.0768	1.65	1.95	H	-	*0.0906	-	*2.30
C	0.0354	0.0591	0.90	1.50	I	-	0.0354	-	0.90
D	0.0177	0.0236	0.45	0.60	J	-	0.0315	-	0.80
E	0.2520	0.2677	6.40	6.80	K	0.2047	0.2165	5.20	5.50
F	0.2125	0.2283	5.40	5.80	L	0.0551	0.0630	1.40	1.60

Notes: 1.Controlling dimension: millimeters.
 2.Maximum lead thickness includes lead finish thickness, and minimum lead thickness is the minimum thickness of base material.
 3.If there is any question with packing specification or packing method, please contact your local CYStek sales office.

Material:

- Lead: 42 Alloy; solder plating
- Mold Compound: Epoxy resin family, flammability solid burning class: UL94V-0

Important Notice:

- All rights are reserved. Reproduction in whole or in part is prohibited without the prior written approval of CYStek.
- CYStek reserves the right to make changes to its products without notice.
- CYStek **semiconductor products are not warranted to be suitable for use in Life-Support Applications, or systems.**
- CYStek assumes no liability for any consequence of customer product design, infringement of patents, or application assistance.