

查询"LM1-THR1-11-N1"供应商

Cree® SMD LED

Model # LM1-THR1-11-N1

Data Sheet

120-degree, 3.2 x 2.7 mm, power SMD LED in red color with water-transparent lens

Applications

- Indicators
- Illuminations
- LCD Back Lights
- Automobile Applications
- RGB Full-Color Displays

Absolute Maximum Ratings ($T_A = 25^\circ\text{C}$)

Items	Symbol	Absolute Maximum Rating	Unit
Forward Current	I_F	70	mA
Peak Forward Current ^{Note 1}	I_{FP}	200	mA
Reverse Voltage	V_R	5	V
Power Dissipation	P_D	225	mW
Operation Temperature	T_{opr}	-40 ~ +100	°C
Storage Temperature	T_{stg}	-40 ~ +100	°C
Junction Temperature	T_J	110	°C
Junction/Ambient ^{Note 2}	R_{THJA}	300	°C/W
Junction/Solder Point	R_{THJS}	150	°C/W

Notes:

1. Pulse width ≤ 0.1 msec, duty $\leq 1/10$.
2. Rth test condition: mounted on PCB FR4 (pad size ≥ 16 mm²)

Typical Electrical & Optical Characteristics ($T_A = 25^\circ\text{C}$)

Characteristics	Symbol	Condition	Unit	Minimum	Typical	Maximum
Forward Voltage	V_F	$I_F = 50$ mA	V		2.5	3.2
Reverse Current	I_R	$V_R = 5$ V	A			10
Luminous Intensity	I_V	$I_F = 50$ mA	mcd	560	900	
Dominant Wavelength	λ_D	$I_F = 50$ mA	nm	620	628	635
50% Power Angle	$2\theta_{1/2}$	$I_F = 50$ mA	deg		120	

Standard Bins for LM1-THR1-11-N1 ($I_f = 50 \text{ mA}$)

Lamps are sorted to luminous intensity (I_v) and dominant wavelength (λ_d) bins shown.

Orders for LM1-TYL1-11-N1 may be filled with any or all bins contained as below.

All luminous intensity (I_v) and dominant wavelength (λ_d) values shown and specified are at $I_f = 50 \text{ mA}$.

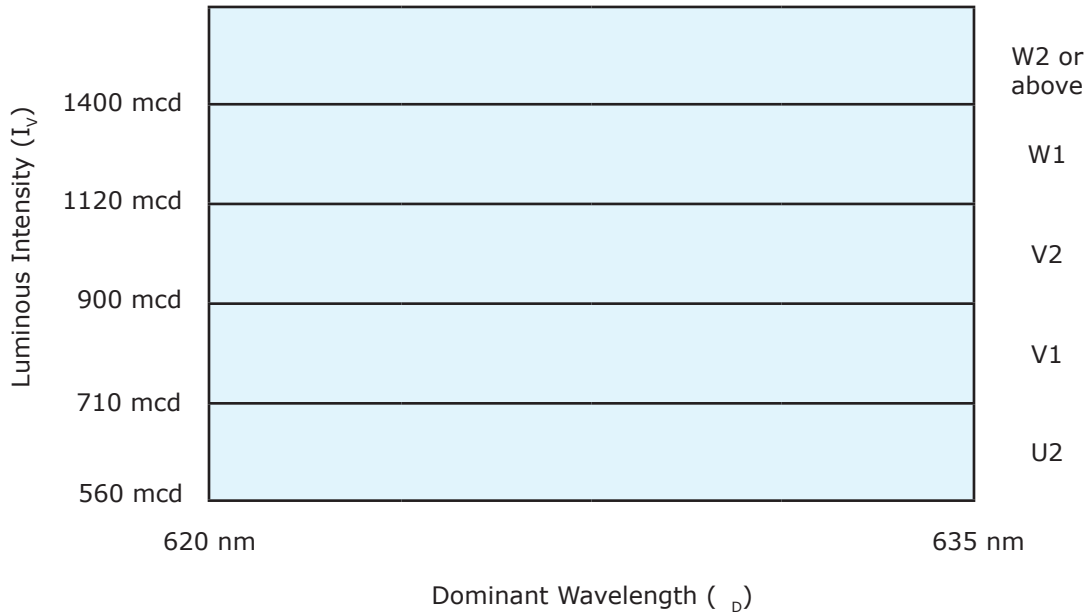

Important Notes:

1. All ranks will be included per delivery; rank ratio will be based on the dice distribution.
2. Tolerance of measurement of luminous intensity is $\pm 10\%$.
3. Tolerance of measurement of the dominant wavelength is $\pm 1 \text{ nm}$.
4. Tolerance of measurement of V_f is $\pm 0.05 \text{ V}$.
5. Packaging methods are available for selection; please refer to the "Cree LED Lamp Packaging Standard" document.
6. Please refer to the "Cree LED Lamp Reliability Test Standards" document for reliability test conditions.
7. Please refer to the "Cree LED Lamp Soldering & Handling" document for information about how to use this LED product safely.

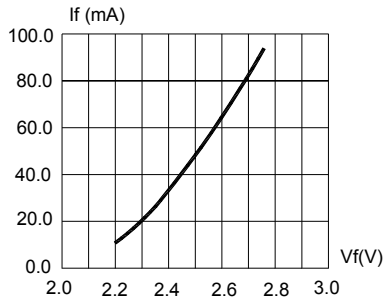

FIG.1 FORWARD CURRENT VS. FORWARD VOLTAGE.

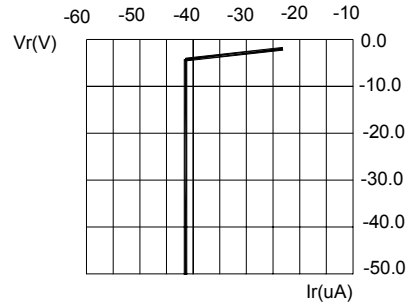

FIG.2 REVERSE CURRENT VS. REVERSE VOLTAGE.

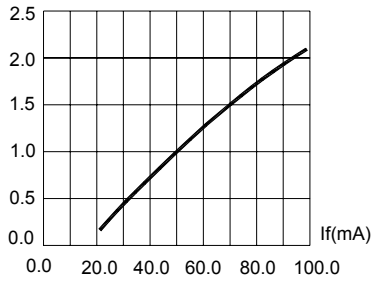

FIG.3 RELATIVE INTENSITY VS. FORWARD CURRENT

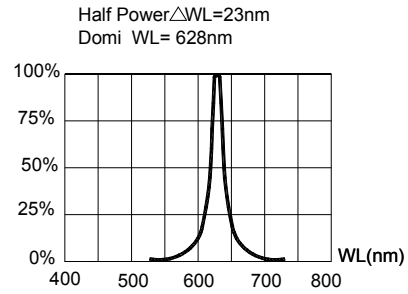

FIG.4 RELATIVE LUMINOUS INTENSITY VS. WAVELENGTH.

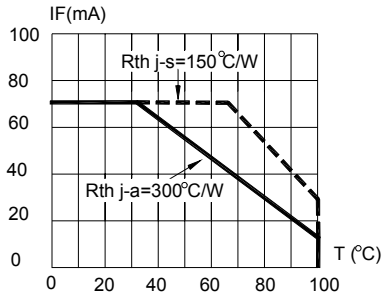

FIG.5 MAXIMUM FORWARD DC CURRENT VS TEMPERATURE. DERATING BASED ON Tjmax=110°C

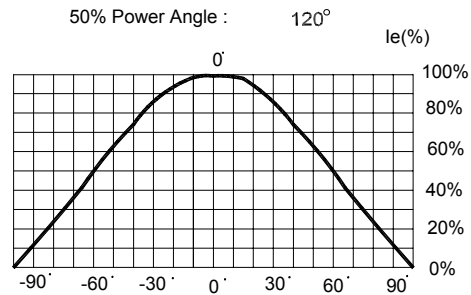
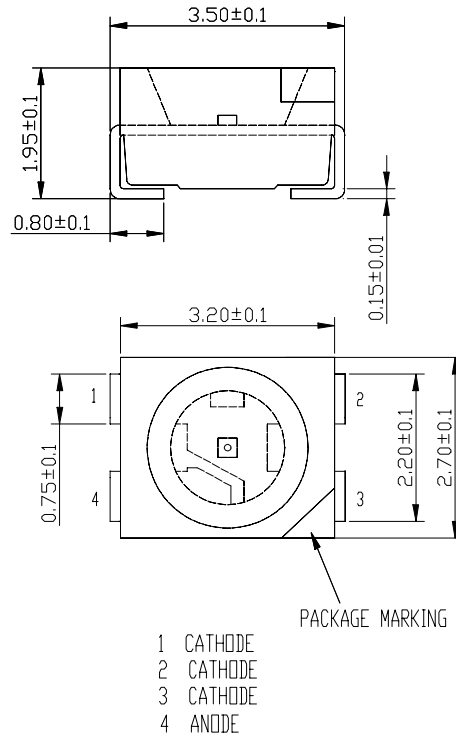

FIG.6 FAR FIELD PATTERN

Mechanical Dimensions

All dimensions are in mm.



Notes

RoHS Compliance

The levels of environmentally sensitive, persistent biologically toxic (PBT), persistent organic pollutants (POP), or otherwise restricted materials in this product are below the maximum concentration values (also referred to as the threshold limits) permitted for such substances, or are used in an exempted application, in accordance with EU Directive 2002/95/EC on the restriction of the use of certain hazardous substances in electrical and electronic equipment (RoHS), as amended through April 21, 2006.

Vision Advisory Claim

Users should be cautioned not to stare at the light of this LED product. The bright light can damage the eye.

Kit Number System

Cree LED lamps are tested and sorted into performance bins. A bin is specified by ranges of color, forward voltage, and brightness. Sorted LEDs are packaged for shipping in various convenient options. Please refer to the "Cree LED Lamp Packaging Standard" document for more information about shipping and packaging options.

Cree LEDs are sold by order codes in combinations of bins called kits. Order codes are configured in the following manner:

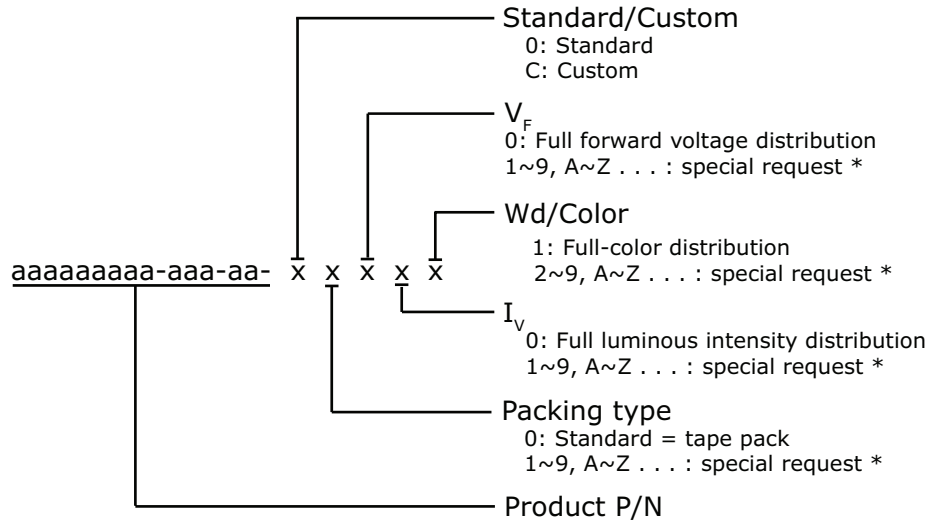

* Contact your Cree sales representative for ordering information.

Standard Available Kits*

Kit Number	Description
LM1-THR1-11-N1-00001	SMD 120 High Red 628nm, FULL RANK, Tape & Reel

* Please contact your Cree representative about the availability of non-standard kits.