

Dual and Quad 100MHz Current Feedback Amplifiers

FEATURES

- 100MHz Bandwidth
- 1000V/ μ s Slew Rate
- Low Cost
- 30mA Output Drive Current
- 0.04% Differential Gain
- 0.1° Differential Phase
- High Input Impedance: 25M Ω , 3pF
- Wide Supply Range: \pm 2V to \pm 15V
- Low Supply Current: 6mA Per Amplifier
- Inputs Common Mode to Within 1.5V of Supplies
- Outputs Swing Within 0.8V of Supplies

APPLICATIONS

- Video Instrumentation Amplifiers
- Cable Drivers
- RGB Amplifiers
- Test Equipment Amplifiers

DESCRIPTION

The LT1229/LT1230 dual and quad 100MHz current feedback amplifiers are designed for maximum performance in small packages. Using industry standard pinouts, the dual is available in the 8-pin miniDIP and the 8-pin SO package while the quad is in the 14-pin DIP and 14-pin SO. The amplifiers are designed to operate on almost any available supply voltage from 4V (\pm 2V) to 30V (\pm 15V).

These current feedback amplifiers have very high input impedance and make excellent buffer amplifiers. They maintain their wide bandwidth for almost all closed-loop voltage gains. The amplifiers drive over 30mA of output current and are optimized to drive low impedance loads, such as cables, with excellent linearity at high frequencies.

The LT1229/LT1230 are manufactured on Linear Technology's proprietary complementary bipolar process. For a single amplifier like these see the LT1227 and for better DC accuracy see the LT1223.

TYPICAL APPLICATION

Video Loop Through Amplifier

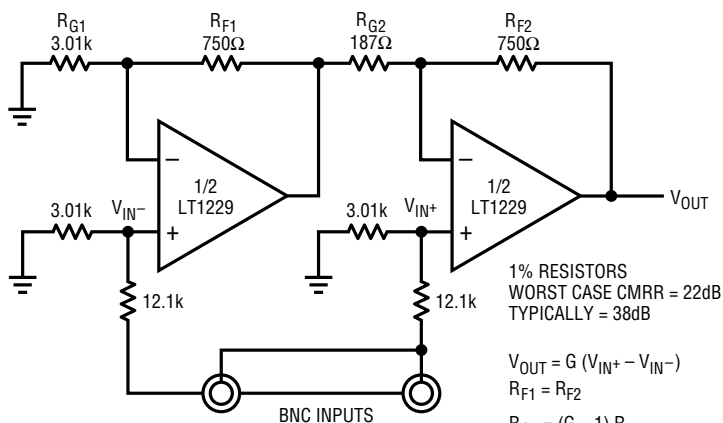

HIGH INPUT RESISTANCE DOES NOT LOAD CABLE EVEN WHEN POWER IS OFF

LT1229 • TA01

Loop Through Amplifier Frequency Response

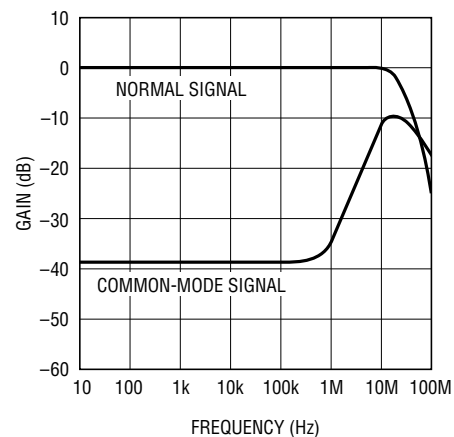

ABSOLUTE MAXIMUM RATINGS

Supply Voltage	±18V	Storage Temperature Range	-65°C to 150°C
Input Current	±15mA	Junction Temperature	
Output Short Circuit Duration (Note 1)	Continuous	Plastic Package	150°C
Operating Temperature Range		Ceramic Package	175°C
LT1229C, LT1230C	0°C to 70°C	Lead Temperature (Soldering, 10 sec.)	300°C
LT1229M, LT1230M	-55°C to 125°C		

PACKAGE/ORDER INFORMATION

<p>J8 PACKAGE N8 PACKAGE 8-LEAD CERAMIC DIP 8-LEAD PLASTIC DIP</p> <p>S8 PACKAGE 8-LEAD PLASTIC SOIC LT1124 • POI01</p> <p>$T_J \text{ MAX} = 175^\circ\text{C}, \theta_{JA} = 100^\circ\text{C/W (J8)}$ $T_J \text{ MAX} = 150^\circ\text{C}, \theta_{JA} = 100^\circ\text{C/W (N8)}$ $T_J \text{ MAX} = 150^\circ\text{C}, \theta_{JA} = 150^\circ\text{C/W (S8)}$</p>	ORDER PART NUMBER	<p>J PACKAGE N PACKAGE 14-LEAD CERAMIC DIP 14-LEAD PLASTIC DIP</p> <p>S PACKAGE 14-LEAD PLASTIC SOIC LT1229 • POI02</p> <p>$T_J \text{ MAX} = 175^\circ\text{C}, \theta_{JA} = 80^\circ\text{C/W (J)}$ $T_J \text{ MAX} = 150^\circ\text{C}, \theta_{JA} = 70^\circ\text{C/W (N)}$ $T_J \text{ MAX} = 150^\circ\text{C}, \theta_{JA} = 110^\circ\text{C/W (S)}$</p>	ORDER PART NUMBER
	LT1229MJ8		LT1230MJ
	LT1229CJ8		LT1230CJ
	LT1229CN8		LT1230CN
LT1229CS8	LT1230CS		
S8 PART MARKING			
1229			

ELECTRICAL CHARACTERISTICS

Each Amplifier, $V_{CM} = 0V, \pm 5V \leq V_S = \pm 15V$, pulse tested unless otherwise noted.

SYMBOL	PARAMETER	CONDITIONS	MIN	TYP	MAX	UNITS
V_{OS}	Input Offset Voltage	$T_A = 25^\circ\text{C}$	●	±3	±10	mV
	Input Offset Voltage Drift		●	10	±15	$\mu\text{V}/^\circ\text{C}$
I_{IN}^+	Noninverting Input Current	$T_A = 25^\circ\text{C}$	●	±0.3	±3	μA
I_{IN}^-	Inverting Input Current	$T_A = 25^\circ\text{C}$	●	±10	±50	μA
e_n	Input Noise Voltage Density	$f = 1\text{kHz}, R_F = 1\text{k}, R_G = 10\Omega, R_S = 0\Omega$		3.2		$\text{nV}/\sqrt{\text{Hz}}$
$+i_n$	Noninverting Input Noise Current Density	$f = 1\text{kHz}, R_F = 1\text{k}, R_G = 10\Omega, R_S = 10\text{k}$		1.4		$\text{pA}/\sqrt{\text{Hz}}$
$-i_n$	Inverting Input Noise Current Density	$f = 1\text{kHz}$		32		$\text{pA}/\sqrt{\text{Hz}}$
R_{IN}	Input Resistance	$V_{IN} = \pm 13V, V_S = \pm 15V$	●	2	25	$\text{M}\Omega$
		$V_{IN} = \pm 3V, V_S = \pm 5V$	●	2	25	$\text{M}\Omega$
C_{IN}	Input Capacitance			3		pF
CMRR	Common-Mode Rejection Ratio	$V_S = \pm 15V, V_{CM} = \pm 13V, T_A = 25^\circ\text{C}$	●	±13	±13.5	V
		$V_S = \pm 15V, V_{CM} = \pm 12V$	●	±12		V
		$V_S = \pm 5V, V_{CM} = \pm 3V, T_A = 25^\circ\text{C}$	●	±3	±3.5	V
		$V_S = \pm 5V, V_{CM} = \pm 2V$	●	±2		V
CMRR	Common-Mode Rejection Ratio	$V_S = \pm 15V, V_{CM} = \pm 13V, T_A = 25^\circ\text{C}$	●	55	69	dB
		$V_S = \pm 15V, V_{CM} = \pm 12V$	●	55		dB
		$V_S = \pm 5V, V_{CM} = \pm 3V, T_A = 25^\circ\text{C}$	●	55	69	dB
		$V_S = \pm 5V, V_{CM} = \pm 2V$	●	55		dB

ELECTRICAL CHARACTERISTICS

Each Amplifier, $V_{CM} = 0V$, $\pm 5V \leq V_S \leq \pm 15V$, pulse tested unless otherwise noted.

SYMBOL	PARAMETER	CONDITIONS	MIN	TYP	MAX	UNITS
	Inverting Input Current Common-Mode Rejection	$V_S = \pm 15V$, $V_{CM} = \pm 13V$, $T_A = 25^\circ C$	●	2.5	10	$\mu A/V$
		$V_S = \pm 15V$, $V_{CM} = \pm 12V$	●		10	$\mu A/V$
		$V_S = \pm 5V$, $V_{CM} = \pm 3V$, $T_A = 25^\circ C$	●	2.5	10	$\mu A/V$
		$V_S = \pm 5V$, $V_{CM} = \pm 2V$	●		10	$\mu A/V$
PSRR	Power Supply Rejection Ratio	$V_S = \pm 2V$ to $\pm 15V$, $T_A = 25^\circ C$ $V_S = \pm 3V$ to $\pm 15V$	● 60 60	80		dB dB
	Noninverting Input Current Power Supply Rejection	$V_S = \pm 2V$ to $\pm 15V$, $T_A = 25^\circ C$	●	10	50	nA/V nA/V
		$V_S = \pm 3V$ to $\pm 15V$	●		50	nA/V
A_V	Large-Signal Voltage Gain, (Note 2)	$V_S = \pm 15V$, $V_{OUT} = \pm 10V$, $R_L = 1k$	●	55	65	dB
		$V_S = \pm 5V$, $V_{OUT} = \pm 2V$, $R_L = 150\Omega$	●	55	65	dB
R_{OL}	Transresistance, $\Delta V_{OUT}/\Delta I_{IN-}$, (Note 2)	$V_S = \pm 15V$, $V_{OUT} = \pm 10V$, $R_L = 1k$ $V_S = \pm 5V$, $V_{OUT} = \pm 2V$, $R_L = 150\Omega$	● ●	100 100	200 200	k Ω k Ω
V_{OUT}	Maximum Output Voltage Swing, (Note 2)	$V_S = \pm 15V$, $R_L = 400\Omega$, $T_A = 25^\circ C$ $V_S = \pm 5V$, $R_L = 150\Omega$, $T_A = 25^\circ C$	● ●	± 12 ± 10 ± 3 ± 2.5	± 13.5 ± 3.7	V V V V
I_{OUT}	Maximum Output Current	$R_L = 0\Omega$, $T_A = 25^\circ C$		30	65 125	mA
I_S	Supply Current, (Note 3)	$V_{OUT} = 0V$, Each Amplifier, $T_A = 25^\circ C$	●		6 9.5 11	mA mA
SR	Slew Rate, (Notes 4 and 6)	$T_A = 25^\circ C$		300	700	V/ μs
SR	Slew Rate	$V_S = \pm 15V$, $R_F = 750\Omega$, $R_G = 750\Omega$, $R_L = 400\Omega$			2500	V/ μs
t_r	Rise Time, (Notes 5 and 6)	$T_A = 25^\circ C$		10	20	ns
BW	Small-Signal Bandwidth	$V_S = \pm 15V$, $R_F = 750\Omega$, $R_G = 750\Omega$, $R_L = 100\Omega$		100		MHz
t_r	Small-Signal Rise Time	$V_S = \pm 15V$, $R_F = 750\Omega$, $R_G = 750\Omega$, $R_L = 100\Omega$		3.5		ns
	Propagation Delay	$V_S = \pm 15V$, $R_F = 750\Omega$, $R_G = 750\Omega$, $R_L = 100\Omega$		3.5		ns
	Small-Signal Overshoot	$V_S = \pm 15V$, $R_F = 750\Omega$, $R_G = 750\Omega$, $R_L = 100\Omega$		15		%
t_s	Settling Time	0.1%, $V_{OUT} = 10V$, $R_F = 1k$, $R_G = 1k$, $R_L = 1k$		45		ns
	Differential Gain, (Note 7)	$V_S = \pm 15V$, $R_F = 750\Omega$, $R_G = 750\Omega$, $R_L = 1k$		0.01		%
	Differential Phase, (Note 7)	$V_S = \pm 15V$, $R_F = 750\Omega$, $R_G = 750\Omega$, $R_L = 1k$		0.01		Deg
	Differential Gain, (Note 7)	$V_S = \pm 15V$, $R_F = 750\Omega$, $R_G = 750\Omega$, $R_L = 150\Omega$		0.04		%
	Differential Phase, (Note 7)	$V_S = \pm 15V$, $R_F = 750\Omega$, $R_G = 750\Omega$, $R_L = 150\Omega$		0.1		Deg

The ● denotes specifications which apply over the operating temperature range.

Note 1: A heat sink may be required depending on the power supply voltage and how many amplifiers are shorted.

Note 2: The power tests done on $\pm 15V$ supplies are done on only one amplifier at a time to prevent excessive junction temperatures when testing at maximum operating temperature.

Note 3: The supply current of the LT1229/LT1230 has a negative temperature coefficient. For more information see the application information section.

Note 4: Slew rate is measured at $\pm 5V$ on a $\pm 10V$ output signal while operating on $\pm 15V$ supplies with $R_F = 1k$, $R_G = 110\Omega$ and $R_L = 400\Omega$. The

slew rate is much higher when the input is overdriven and when the amplifier is operated inverting, see the applications section.

Note 5: Rise time is measured from 10% to 90% on a $\pm 500mV$ output signal while operating on $\pm 15V$ supplies with $R_F = 1k$, $R_G = 110\Omega$ and $R_L = 100\Omega$. This condition is not the fastest possible, however, it does guarantee the internal capacitances are correct and it makes automatic testing practical.

Note 6: AC parameters are 100% tested on the ceramic and plastic DIP packaged parts (J and N suffix) and are sample tested on every lot of the SO packaged parts (S suffix).

Note 7: NTSC composite video with an output level of $2V_p$.

TYPICAL PERFORMANCE CHARACTERISTICS

Voltage Gain and Phase vs Frequency, Gain = 6dB

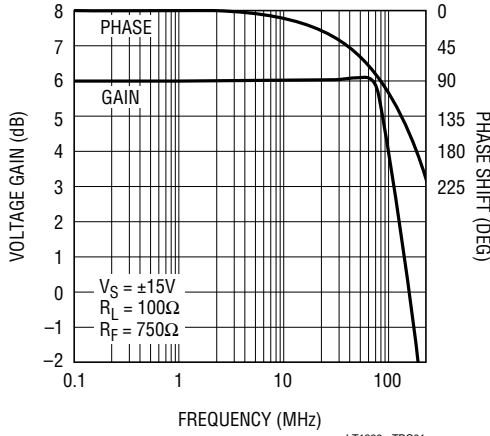

-3dB Bandwidth vs Supply Voltage, Gain = 2, RL = 100Ω

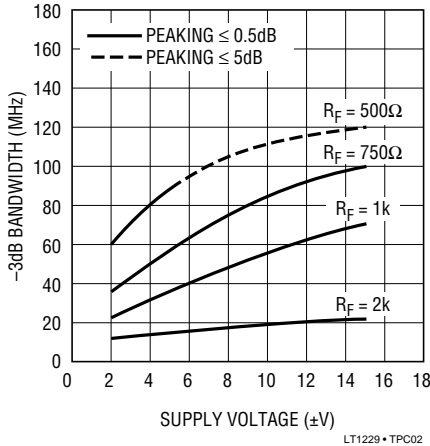

-3dB Bandwidth vs Supply Voltage, Gain = 2, RL = 1k

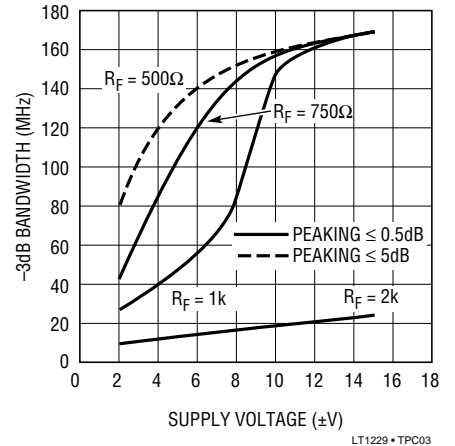

Voltage Gain and Phase vs Frequency, Gain = 20dB

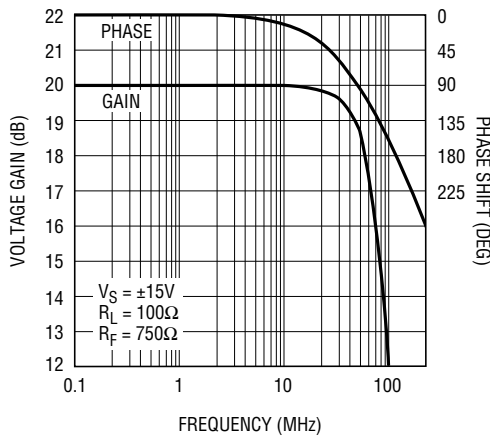

-3dB Bandwidth vs Supply Voltage, Gain = 10, RL = 100Ω

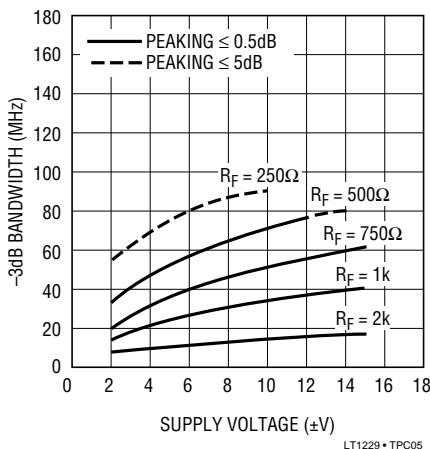

-3dB Bandwidth vs Supply Voltage, Gain = 10, RL = 1k

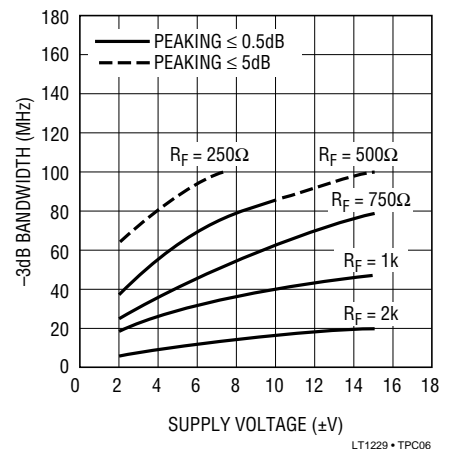

Voltage Gain and Phase vs Frequency, Gain = 40dB

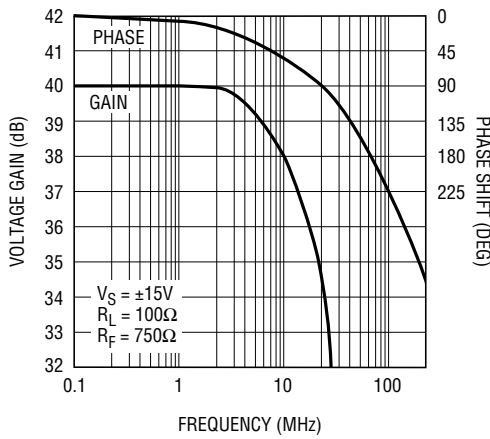

-3dB Bandwidth vs Supply Voltage, Gain = 100, RL = 100Ω

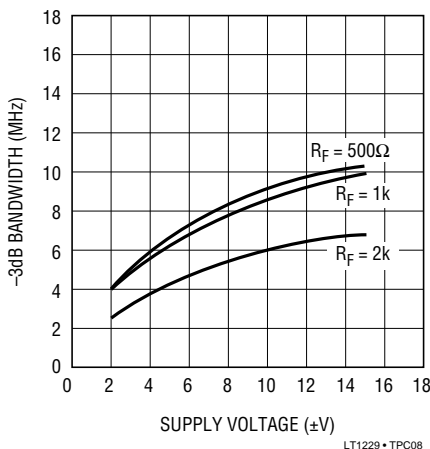

-3dB Bandwidth vs Supply Voltage, Gain = 100, RL = 1kΩ

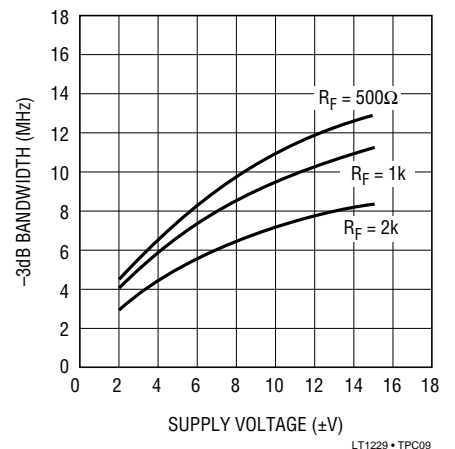

TYPICAL PERFORMANCE CHARACTERISTICS

Maximum Capacitance Load vs Feedback Resistor

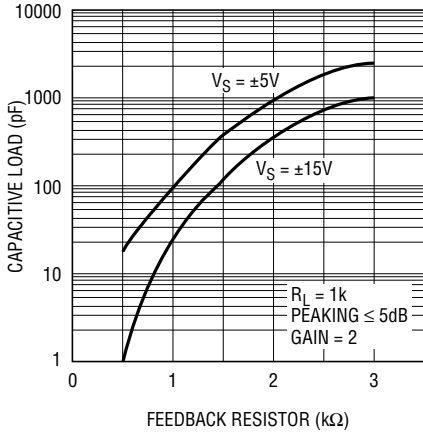

LT1229 • TPC10

Total Harmonic Distortion vs Frequency

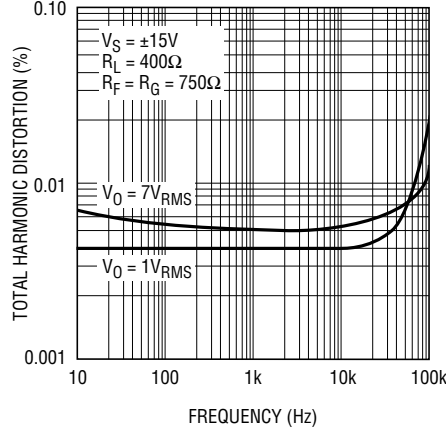

LT1229 • TPC11

2nd and 3rd Harmonic Distortion vs Frequency

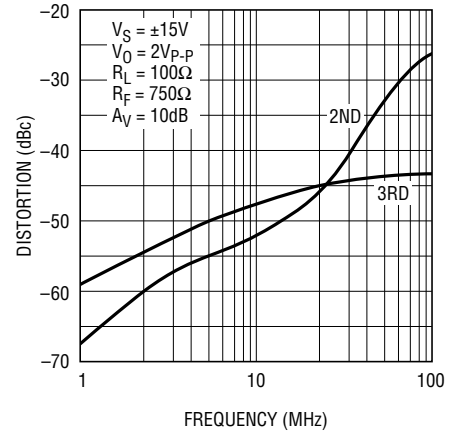

LT1229 • TPC12

Input Common-Mode Limit vs Temperature

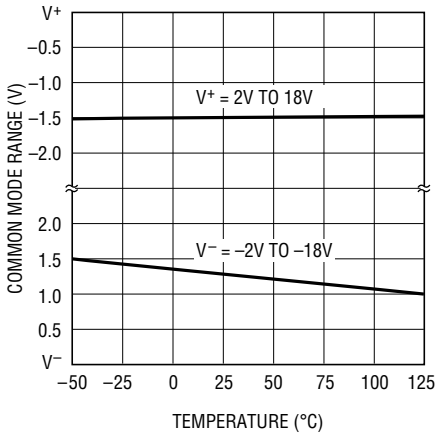

LT1229 • TPC13

Output Saturation Voltage vs Temperature

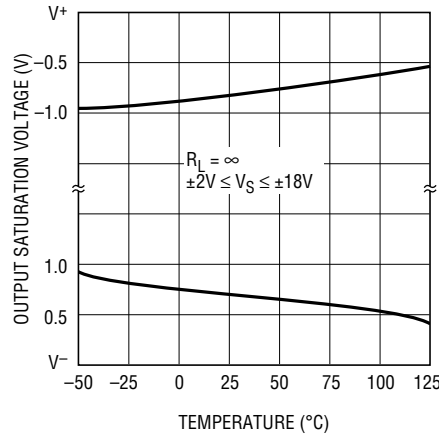

LT1229 • TPC14

Output Short-Circuit Current vs Junction Temperature

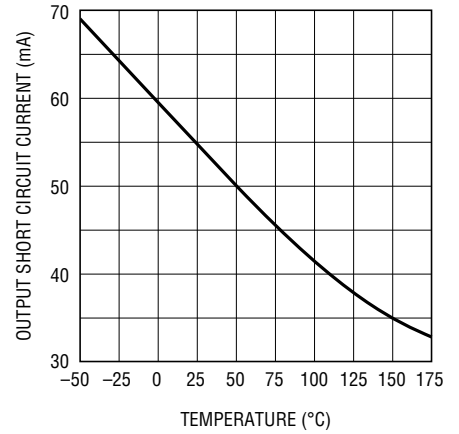

LT1229 • TPC15

Spot Noise Voltage and Current vs Frequency

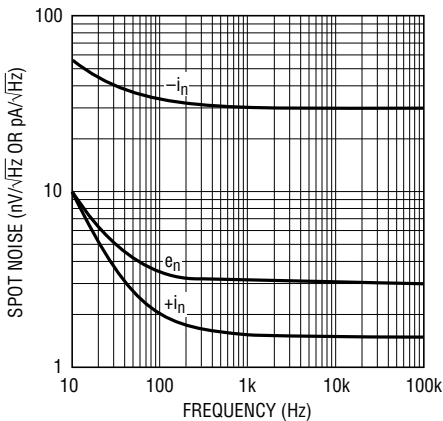

LT1229 • TPC16

Power Supply Rejection vs Frequency

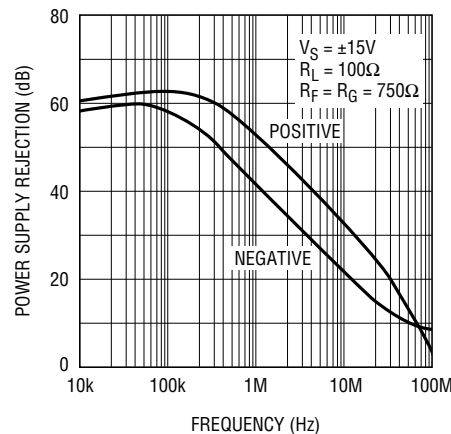

LT1229 • TPC17

Output Impedance vs Frequency

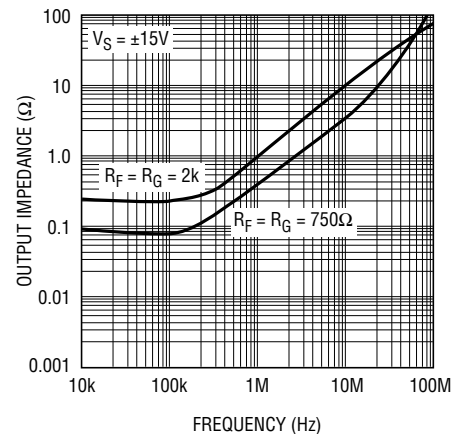

LT1229 • TPC18

TYPICAL PERFORMANCE CHARACTERISTICS

Settling Time to 10mV vs Output Step

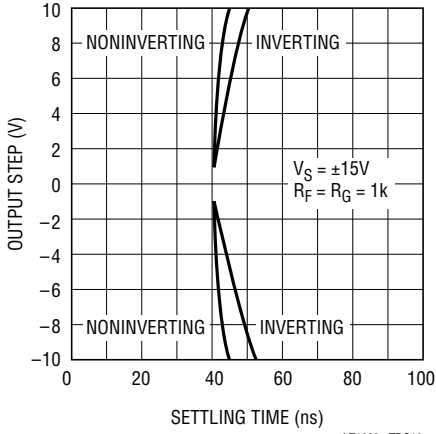

LT1229 • TPC19

Settling Time to 1mV vs Output Step

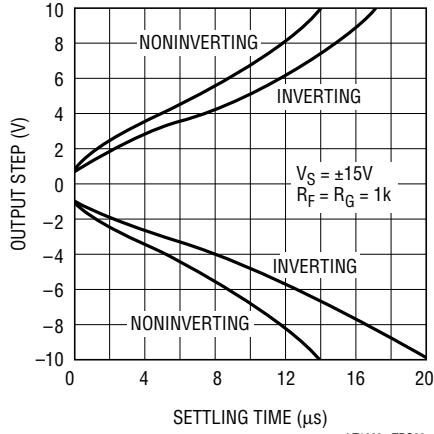

LT1229 • TPC20

Supply Current vs Supply Voltage

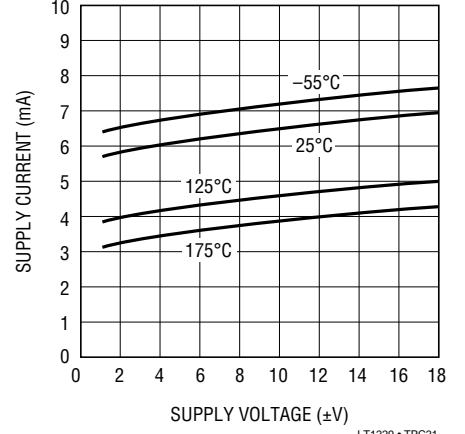

LT1229 • TPC21

SIMPLIFIED SCHEMATIC

One Amplifier

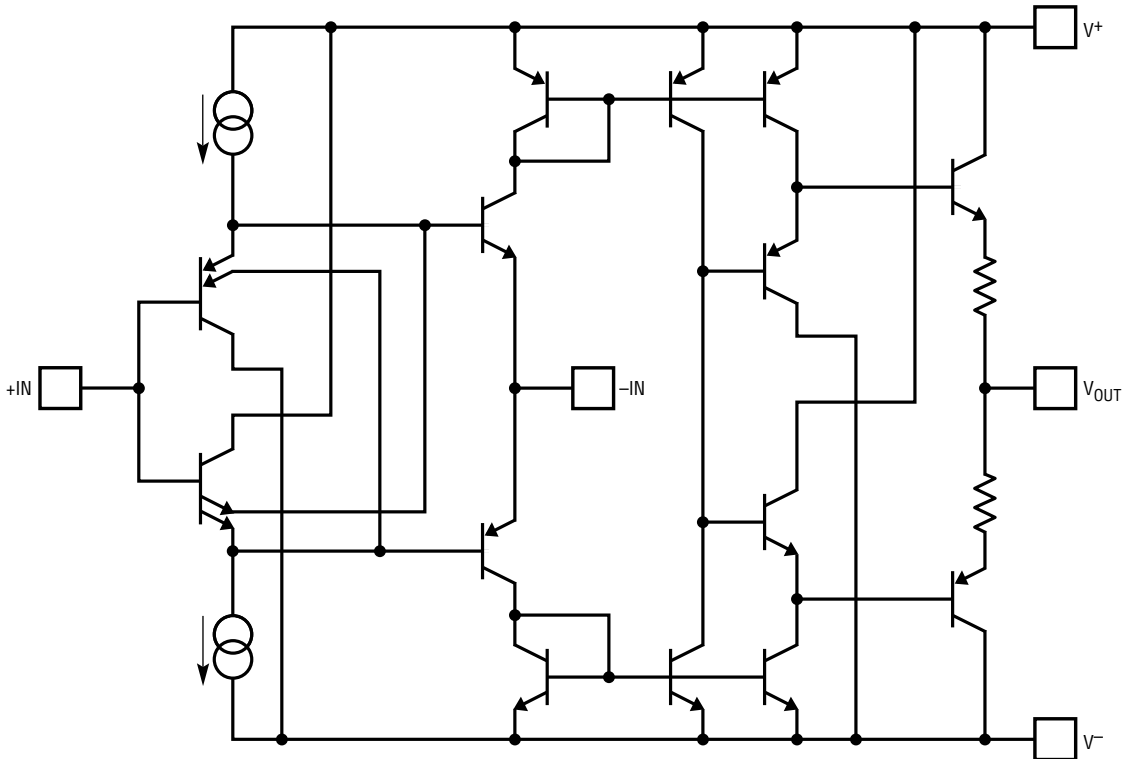

LT1229 • TA03

APPLICATIONS INFORMATION

The LT1229/LT1230 are very fast dual and quad current feedback amplifiers. Because they are current feedback amplifiers, they maintain their wide bandwidth over a wide range of voltage gains. These amplifiers are designed to drive low impedance loads such as cables with excellent linearity at high frequencies.

Feedback Resistor Selection

The small-signal bandwidth of the LT1229/LT1230 is set by the external feedback resistors and the internal junction capacitors. As a result, the bandwidth is a function of the supply voltage, the value of the feedback resistor, the closed-loop gain and load resistor. The characteristic curves of Bandwidth versus Supply Voltage are done with a heavy load (100Ω) and a light load (1k) to show the effect of loading. These graphs also show the family of curves that result from various values of the feedback resistor. These curves use a solid line when the response has less than 0.5dB of peaking and a dashed line when the response has 0.5dB to 5dB of peaking. The curves stop where the response has more than 5dB of peaking.

Small-Signal Rise Time with $R_F = R_G = 750\Omega$, $V_S = \pm 15V$, and $R_L = 100\Omega$

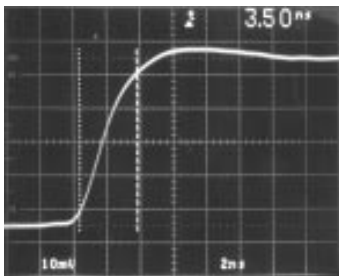

LT1229 • TA04

At a gain of two, on $\pm 15V$ supplies with a 750Ω feedback resistor, the bandwidth into a light load is over 160MHz without peaking, but into a heavy load the bandwidth reduces to 100MHz. The loading has so much effect because there is a mild resonance in the output stage that enhances the bandwidth at light loads but has its Q reduced by the heavy load. This enhancement is only useful at low gain settings; at a gain of ten it does not boost the bandwidth. At unity gain, the enhancement is so effective the value of the feedback resistor has very little effect. At very high closed-loop gains, the bandwidth is

limited by the gain bandwidth product of about 1GHz. The curves show that the bandwidth at a closed-loop gain of 100 is 10MHz, only one tenth what it is at a gain of two.

Capacitance on the Inverting Input

Current feedback amplifiers want resistive feedback from the output to the inverting input for stable operation. Take care to minimize the stray capacitance between the output and the inverting input. Capacitance on the inverting input to ground will cause peaking in the frequency response (and overshoot in the transient response), but it does not degrade the stability of the amplifier. The amount of capacitance that is necessary to cause peaking is a function of the closed-loop gain taken. The higher the gain, the more capacitance is required to cause peaking. We can add capacitance from the inverting input to ground to increase the bandwidth in high gain applications. For example, in this gain of 100 application, the bandwidth can be increased from 10MHz to 17MHz by adding a 2200pF capacitor.

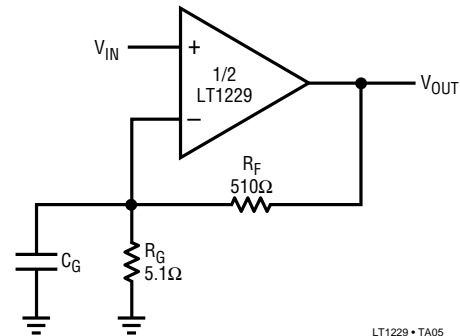

LT1229 • TA05

Boosting Bandwidth of High Gain Amplifier with Capacitance on Inverting Input

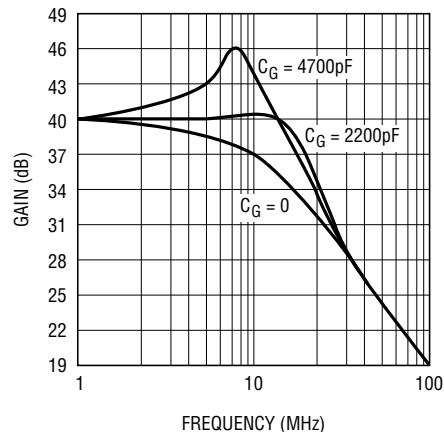

LT1229 • TA06

APPLICATIONS INFORMATION

Capacitive Loads

The LT1229/LT1230 can drive capacitive loads directly when the proper value of feedback resistor is used. The graph Maximum Capacitive Load vs Feedback Resistor should be used to select the appropriate value. The value shown is for 5dB peaking when driving a 1k load at a gain of 2. This is a worst case condition; the amplifier is more stable at higher gains and driving heavier loads. Alternatively, a small resistor (10Ω to 20Ω) can be put in series with the output to isolate the capacitive load from the amplifier output. This has the advantage that the amplifier bandwidth is only reduced when the capacitive load is present, and the disadvantage that the gain is a function of the load resistance.

Power Supplies

The LT1229/LT1230 amplifiers will operate from single or split supplies from ±2V (4V total) to ±15V (30V total). It is not necessary to use equal value split supplies, however, the offset voltage and inverting input bias current will change. The offset voltage changes about 350μV per volt of supply mismatch, the inverting bias current changes about 2.5μA per volt of supply mismatch.

Power Dissipation

The LT1229/LT1230 amplifiers combine high speed and large output current drive into very small packages. Because these amplifiers work over a very wide supply range, it is possible to exceed the maximum junction temperature under certain conditions. To ensure that the LT1229 and LT1230 remain within their absolute maximum ratings, we must calculate the worst case power dissipation, define the maximum ambient temperature, select the appropriate package and then calculate the maximum junction temperature.

The worst case amplifier power dissipation is the total of the quiescent current times the total power supply voltage plus the power in the IC due to the load. The quiescent supply current of the LT1229/LT1230 has a strong negative temperature coefficient. The supply current of each

amplifier at 150°C is less than 7mA and typically is only 4.5mA. The power in the IC due to the load is a function of the output voltage, the supply voltage and load resistance. The worst case occurs when the output voltage is at half supply, if it can go that far, or its maximum value if it cannot reach half supply.

For example, let's calculate the worst case power dissipation in a video cable driver operating on ±12V supplies that delivers a maximum of 2V into 150Ω.

$$P_d(\text{MAX}) = 2V_S I_S(\text{MAX}) + (V_S - V_O(\text{MAX})) \frac{V_O(\text{MAX})}{R_L}$$

$$P_d(\text{MAX}) = 2 \times 12V \times 7\text{mA} + (12V - 2V) \times \frac{2V}{150\Omega}$$

$$= 0.168 + 0.133 = 0.301\text{W per Amp}$$

Now if that is the dual LT1229, the total power in the package is twice that, or 0.602W. We now must calculate how much the die temperature will rise above the ambient. The total power dissipation times the thermal resistance of the package gives the amount of temperature rise. For the above example, if we use the SO8 surface mount package, the thermal resistance is 150°C/W junction to ambient in still air.

$$\text{Temperature Rise} = P_d(\text{MAX}) R_{\theta\text{JA}} = 0.602\text{W} \times 150^\circ\text{C/W} = 90.3^\circ\text{C}$$

The maximum junction temperature allowed in the plastic package is 150°C. Therefore, the maximum ambient allowed is the maximum junction temperature less the temperature rise.

$$\text{Maximum Ambient} = 150^\circ\text{C} - 90.3^\circ\text{C} = 59.7^\circ\text{C}$$

Note that this is less than the maximum of 70°C that is specified in the absolute maximum data listing. If we must use this package at the maximum ambient we must lower the supply voltage or reduce the output swing.

As a guideline to help in the selection of the LT1229/LT1230 the following table describes the maximum supply voltage that can be used with each part in cable driving applications.

APPLICATIONS INFORMATION

Assumptions:

1. The maximum ambient is 70°C for the commercial parts (C suffix) and 125°C for the full temperature parts (M suffix).
2. The load is a double-terminated video cable, 150Ω.
3. The maximum output voltage is 2V (peak or DC).
4. The thermal resistance of each package:

J8 is 100°C/W	J is 80°C/W
N8 is 100°C/W	N is 70°C/W
S8 is 150°C/W	S is 110°C/W

Maximum Supply Voltage for 75Ω Cable Driving Applications at Maximum Ambient Temperature

PART	PACKAGE	MAX POWER AT T _A	MAX SUPPLY
LT1229MJ8	Ceramic DIP	0.500W @ 125°C	V _S < ±10.1
LT1229CJ8	Ceramic DIP	1.050W @ 70°C	V _S < ±18.0
LT1229CN8	Plastic DIP	0.800W @ 70°C	V _S < ±15.6
LT1229CS8	Plastic S08	0.533W @ 70°C	V _S < ±10.6
LT1230MJ	Ceramic DIP	0.625W @ 125°C	V _S < ±6.6
LT1230CJ	Ceramic DIP	1.313W @ 70°C	V _S < ±13.0
LT1230CN	Plastic DIP	1.143W @ 70°C	V _S < ±11.4
LT1230CS	Plastic S014	0.727W @ 70°C	V _S < ±7.6

Slew Rate

The slew rate of a current feedback amplifier is not independent of the amplifier gain the way it is in a traditional op amp. This is because the input stage and the output stage both have slew rate limitations. The input stage of the LT1229/LT1230 amplifiers slew at about 100V/μs before they become nonlinear. Faster input signals will turn on the normally reverse-biased emitters on the input transistors and enhance the slew rate significantly. This enhanced slew rate can be as much as 2500V/μs.

The output slew rate is set by the value of the feedback resistors and the internal capacitance. At a gain of ten with a 1k feedback resistor and ±15V supplies, the output slew rate is typically 700V/μs and -1000V/μs. There is no input stage enhancement because of the high gain.

Large-Signal Response, A_V = 2, R_F = R_G = 750Ω

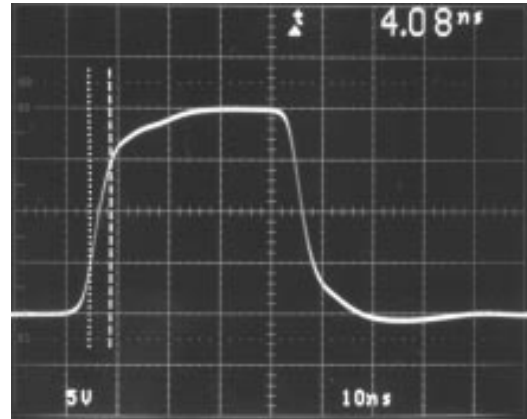

LT1229 • TA07

Larger feedback resistors will reduce the slew rate as will lower supply voltages, similar to the way the bandwidth is reduced.

Large-Signal Response, A_V = 10, R_F = 1k, R_G = 110Ω

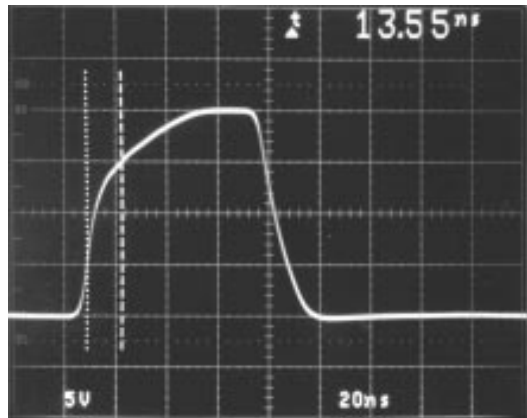

LT1229 • TA08

Settling Time

The characteristic curves show that the LT1229/LT1230 amplifiers settle to within 10mV of final value in 40ns to 55ns for any output step up to 10V. The curve of settling to 1mV of final value shows that there is a slower thermal contribution up to 20μs. The thermal settling component comes from the output and the input stage. The output contributes just under 1mV per volt of output change and the input contributes 300μV per volt of input change. Fortunately, the input thermal tends to cancel the output thermal. For this reason the noninverting gain of two configurations settles faster than the inverting gain of one.

APPLICATIONS INFORMATION

Crosstalk and Cascaded Amplifiers

The amplifiers in the LT1229/LT1230 do not share any common circuitry. The only thing the amplifiers share is the supplies. As a result, the crosstalk between amplifiers is very low. In a good breadboard or with a good PC board layout the crosstalk from the output of one amplifier to the input of another will be over 100dB down, up to 100kHz and 65dB down at 10MHz. The following curve shows the crosstalk from the output of one amplifier to the input of another.

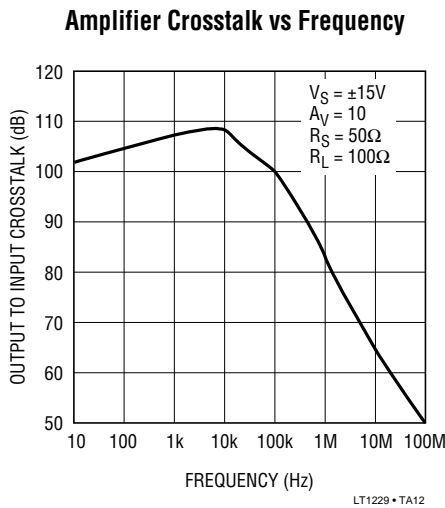

The high frequency crosstalk between amplifiers is caused by magnetic coupling between the internal wire bonds that connect the IC chip to the package lead frame. The amount of crosstalk is inversely proportional to the load resistor the amplifier is driving, with no load (just the feedback resistor) the crosstalk improves 18dB. The curve shows the crosstalk of the LT1229 amplifier B output (pin 7) to the input of amplifier A. The crosstalk from amplifier A's output (pin 1) to amplifier B is about 10dB better. The crosstalk between all of the LT1230 amplifiers is as shown. The LT1230 amplifiers that are separated by the supplies are a few dB better.

When cascading amplifiers the crosstalk will limit the amount of high frequency gain that is available because the crosstalk signal is out of phase with the input signal. This will often show up as unusual frequency response. For example: cascading the two amplifiers in the LT1229, each set up with 20dB of gain and a -3dB bandwidth of 65MHz into 100Ω will result in 40dB of gain, BUT the response will start to drop at about 10MHz and then flatten out from 20MHz to 30MHz at about 0.5dB down. This is due to the crosstalk back to the input of the first amplifier.

For best results when cascading amplifiers use the LT1229 and drive amplifier B and follow it with amplifier A.

TYPICAL APPLICATIONS

Single 5V Supply Cable Driver for Composite Video

This circuit amplifies standard 1V peak composite video input (1.4V_{P-P}) by two and drives an AC coupled, doubly terminated cable. In order for the output to swing 2.8V_{P-P} on a single 5V supply, it must be biased accurately. The average DC level of the composite input is a function of the luminance signal. This will cause problems if we AC couple the input signal into the amplifier because a rapid change in luminance will drive the output into the rails. To prevent this we must establish the DC level at the input and operate the amplifier with DC gain.

The transistor's base is biased by R1 and R2 at 2V. The emitter of the transistor clamps the noninverting input of the amplifier to 1.4V at the most negative part of the input

(the sync pulses). R4, R5 and R6 set the amplifier up with a gain of two and bias the output so the bottom of the sync pulses are at 1.1V. The maximum input then drives the output to 3.9V.

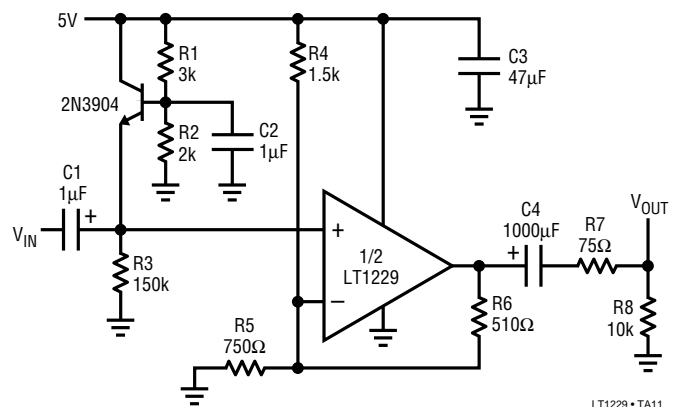

TYPICAL APPLICATIONS

Single Supply AC Coupled Amplifiers

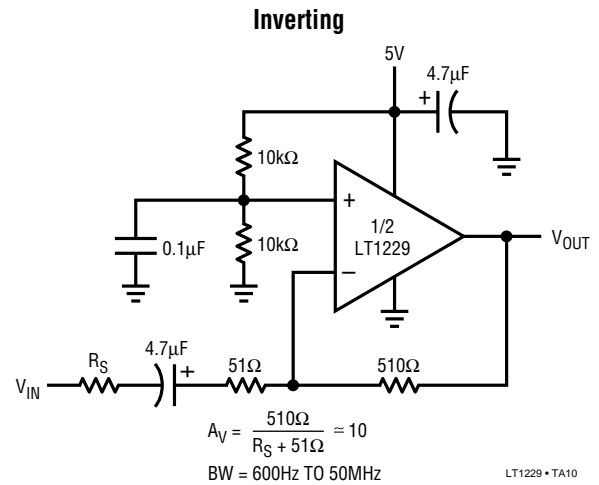
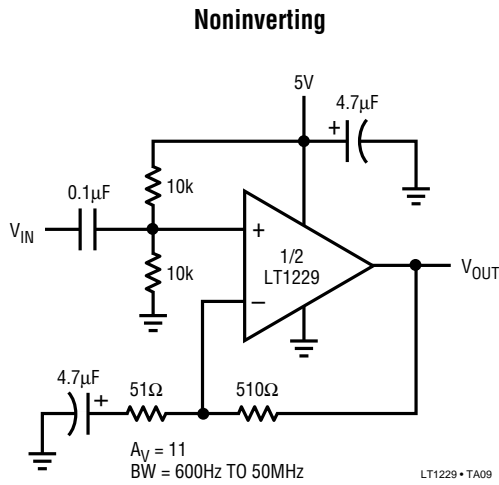

PACKAGE DESCRIPTION

Dimensions in inches (millimeters) unless otherwise noted.

J8 Package 8-Lead Ceramic DIP

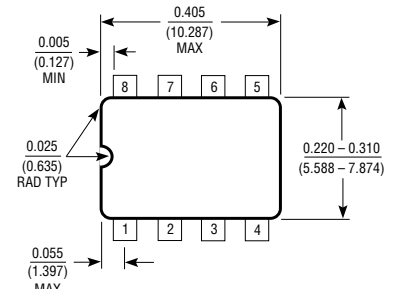
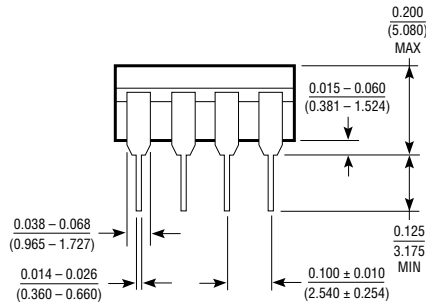
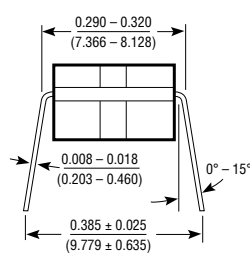

J8 0392

N8 Package 8-Lead Plastic DIP

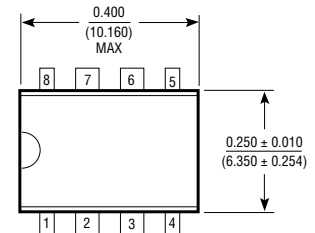
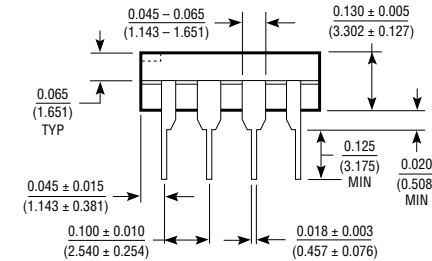
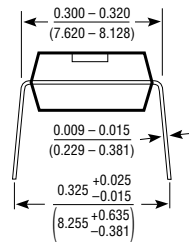

N8 0392

S8 Package 8-Lead Plastic SOIC

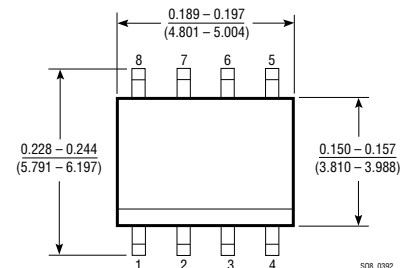
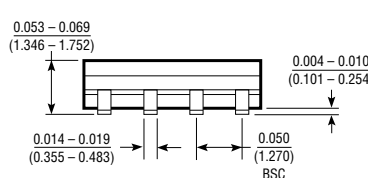
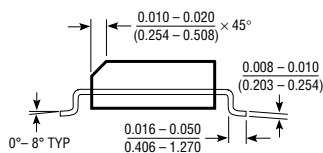

S08 0392

PACKAGE DESCRIPTION Dimensions in inches (millimeters) unless otherwise noted.

J Package 14-Lead Ceramic DIP

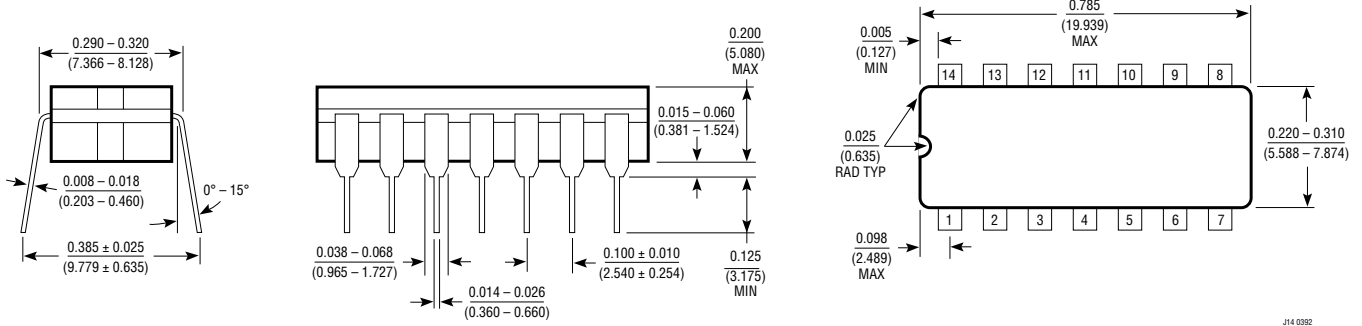

N Package 14-Lead Plastic DIP

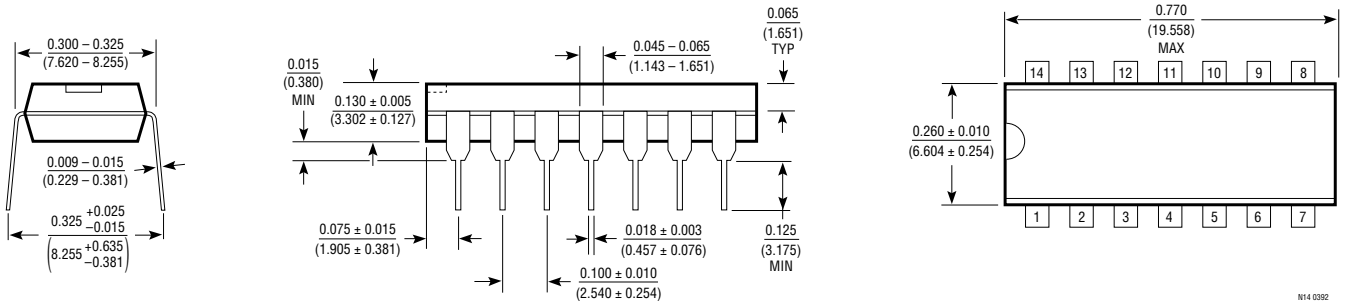

S Package 14-Lead Plastic SOIC

