

# Hi-ACCESS COMPACT HACKSAW

查询"25032"供应商

The Hi-ACCESS hacksaw\* is designed with its blade offset at 90° to the axis of the frame. It will penetrate small openings whilst being both more rigid than a padsaw and giving the user better control. It is invaluable everywhere that junior saws are used – in the workshop, in home improvement and maintenance, in plumbing, in car repairs and in numerous other applications. It will also accept T15 Tension Files with which it can be used to cut in any direction. Available both loose, with fitted hacksaw blade (F152) and as a carded kit complete with both hacksaw blade and two T15 Tension Files (SF152).

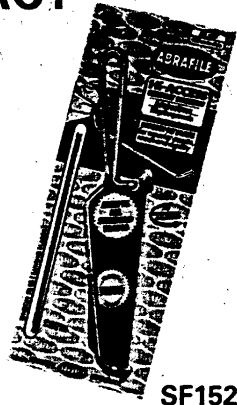

SF152

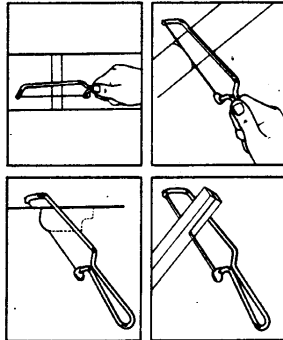
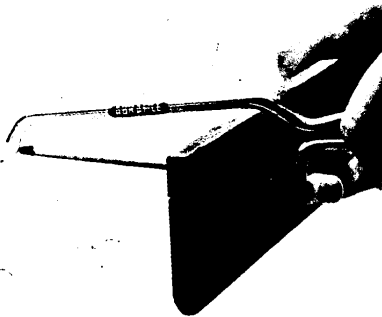

\*(UK Patent No. 2139139; © 1983, P.J. Malone)

# ABRAFRAMES

The junior Abraframes are both light and handy whilst being tougher than many others. The F2010/2015/2020 frames are of flat cross-section and have varnished or lacquered wood handles.

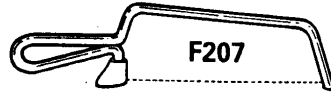

F207



F159



F156

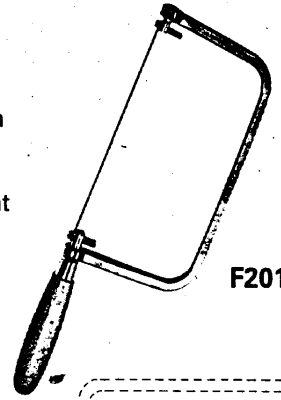

F2010

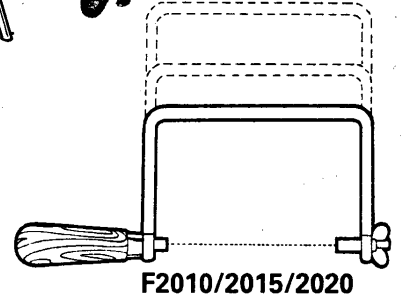

F2010/2015/2020

CAT NO	mm Ax B in.		BOX QTY		oz
F152	150x20 6x0.7	x	10	✓	1,030 37
SF152	150x20 6x0.7	✓	10	✓	1,305 47
F156	150x60 6x2.4	x	10	✓	1,100 39
F159	150x90 6x3.5	x	10	✓	1,240 44
F207	200x70 8x2.8	x	10	✓	1,240 44
F2010	200x120 8x4.7	x	singly	Not boxed	240 8.5
F2015	200x150 8x6	x	singly	Not boxed	270 9.5
F2020	200x200 8x8	x	singly	Not boxed	310 11

# TUNGSTEN CARBIDE RANGE

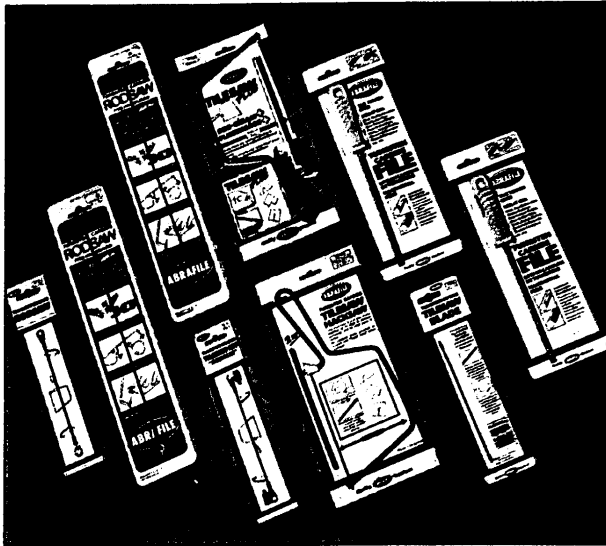

*Abrafile Tungsten Carbide tools for sawing and filing the toughest materials, including floor and wall tiles, bricks concrete stone and marble, glass and pottery, tool steel and wire rope etc. are described in a separate catalogue.*



# OTHER TOOLS

- The **Abrafile Keysaw System** is based on a precision light alloy frame with prismatic bladeholders to secure square three-sides-safe blades to the frame but permitting uni-directional flexing. For locksmiths, engineers, model-makers and others who need to saw slots with a high degree of accuracy. Full details are given in a separate leaflet.
- 250mm (10") **Archimedean Drill (AD1)** and a pack of 12 assorted drill bits (AD12R).
- 130mm (5.1") **Abrafret Fretsaw Blades** are twisted in manufacture which enables the user to saw in any direction (on the 'Abrafile' principle) with minimal risk of snapping the blade whilst doing so. 12 to a card (TOR12).



# ABRASIVE TOOLS LIMITED

Abrafile Works, Colne Road,  
Twickenham TW2 6QE England  
Telephone 01-894 1273