

International IOR Rectifier

MBR350 MBR360

SCHOTTKY RECTIFIER

3.0 Amp

Major Ratings and Characteristics

Characteristics	MBR350 MBR360	Units
$I_{F(AV)}$ Rectangular waveform	3.0	A
V_{RRM}	50/60	V
I_{FSM} @ $t_p = 5 \mu s$ sine	460	A
V_F @ 3 Apk, $T_J = 25^\circ C$	0.73	V
T_J	-40 to 150	$^\circ C$

Description/ Features

The MBR350, MBR360 axial leaded Schottky rectifier has been optimized for very low forward voltage drop, with moderate leakage. Typical applications are in switching power supplies, converters, free-wheeling diodes, and reverse battery protection.

- Low profile, axial leaded outline
- High purity, high temperature epoxy encapsulation for enhanced mechanical strength and moisture resistance
- Very low forward voltage drop
- High frequency operation
- Guard ring for enhanced ruggedness and long term reliability

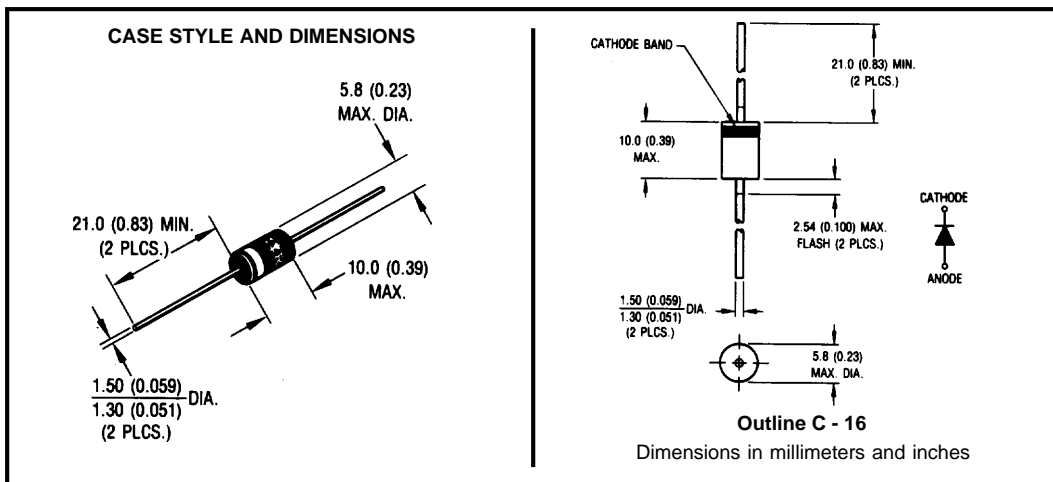

MBR350, MBR360

Bulletin PD-20594 rev. B 03/03



Voltage Ratings

Part number	MBR350	MBR360
V_R Max. DC Reverse Voltage (V)	50	60
V_{RWM} Max. Working Peak Reverse Voltage (V)		

Absolute Maximum Ratings

Parameters	Value	Units	Conditions
$I_{F(AV)}$ Max. Average Forward Current * See Fig. 4	3.0	A	50% duty cycle @ $T_L = 50^\circ\text{C}$, rectangular wave form
I_{FSM} Max. Peak One Cycle Non-Repetitive Surge Current * See Fig. 6	460	A	5 μs Sine or 3 μs Rect. pulse
	80		10ms Sine or 6ms Rect. pulse
E_{AS} Non-Repetitive Avalanche Energy	5.0	mJ	$T_J = 25^\circ\text{C}$, $I_{AS} = 1$ Amps, $L = 10$ mH
I_{AR} Repetitive Avalanche Current	1.0	A	Current decaying linearly to zero in 1 μsec Frequency limited by T_J max. $V_A = 1.5 \times V_R$ typical

Electrical Specifications

Parameters	Value	Units	Conditions
V_{FM} Max. Forward Voltage Drop * See Fig. 1 (1)	0.58	V	@ 1.0A
	0.73	V	@ 3.0A
	1.06	V	@ 9.4A
	0.49	V	@ 1.0A
	0.64	V	@ 3.0A
	0.89	V	@ 9.4A
I_{RM} Max. Reverse Leakage Current * See Fig. 2 (1)	0.6	mA	$T_J = 25^\circ\text{C}$
	8	mA	$T_J = 100^\circ\text{C}$
	15	mA	$T_J = 125^\circ\text{C}$
C_T Typical Junction Capacitance	190	pF	$V_R = 5V_{DC}$ (test signal range 100Khz to 1Mhz) 25°C
L_S Typical Series Inductance	9.0	nH	Measured lead to lead 5mm from package body
dv/dt Max. Voltage Rate of Change	10000	V/ μs	(Rated V_R)

(1) Pulse Width < 300 μs , Duty Cycle <2%

Thermal-Mechanical Specifications

Parameters	Value	Units	Conditions
T_J Max. Junction Temperature Range(*)	-40 to 150	$^\circ\text{C}$	
T_{stg} Max. Storage Temperature Range	-40 to 150	$^\circ\text{C}$	
R_{thJL} Typical Thermal Resistance Junction to Lead (**)	30	$^\circ\text{C}/\text{W}$	DC operation (* See Fig. 4)
wt Approximate Weight	1.2 (0.042)	g (oz.)	
Case Style	C - 16		

(*) $\frac{dP_{tot}}{dT_J} < \frac{1}{R_{th(j-a)}}$ thermal runaway condition for a diode on its own heatsink

(**) Mounted 1 inch square PCB, thermal probe connected to lead 2mm from package

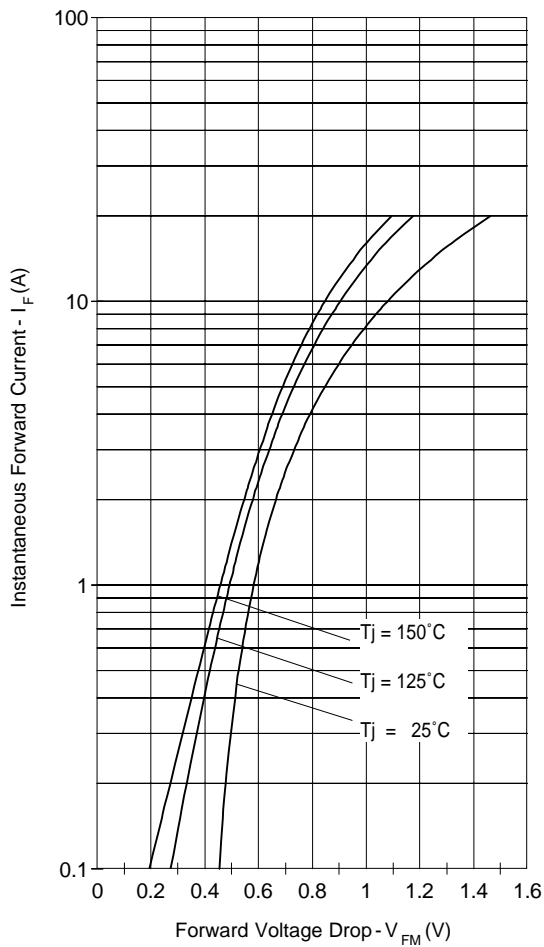

Fig.1 - Max. Forward Voltage Drop Characteristics

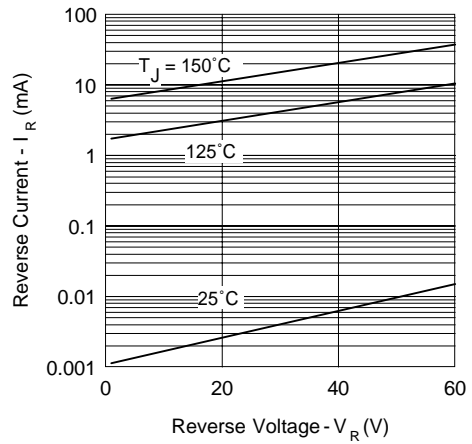

Fig.2 - Typical Values Of Reverse Current Vs. Reverse Voltage

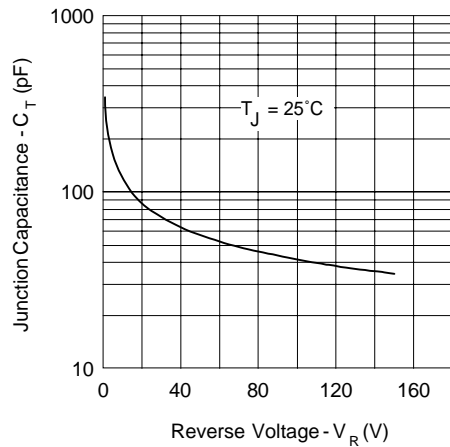

Fig.3 - Typical Junction Capacitance Vs. Reverse Voltage

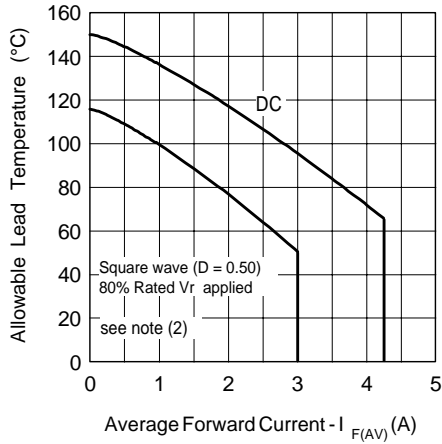

Fig. 4 - Max. Allowable Lead Temperature Vs. Average Forward Current

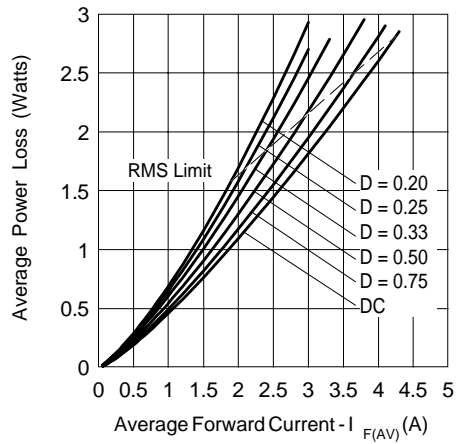

Fig. 5 - Forward Power Loss Characteristics

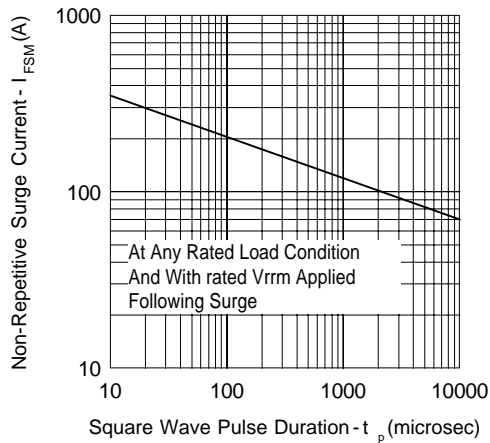

Fig. 6 - Max. Non-Repetitive Surge Current

(2) Formula used: $T_C = T_J - (P_d + P_{d_{REV}}) \times R_{thJC}$;
 $P_d = \text{Forward Power Loss} = I_{F(AV)} \times V_{FM} @ (I_{F(AV)} / D)$ (see Fig. 6);
 $P_{d_{REV}} = \text{Inverse Power Loss} = V_{R1} \times I_R (1 - D); I_R @ V_{R1} = 80\% \text{ rated } V_R$

Ordering Information Table

Device Code			
MBR	3	60	TR
①	②	③	④

1	- Schottky MBR Series
2	- Current Rating: 3 = 3A
3	- Voltage Rating
4	- TR = Tape & Reel package (1200 pcs)
	- = Box package (500 pcs)

40 = 40V
60 = 60V

Data and specifications subject to change without notice.
This product has been designed and qualified for Industrial Level.
Qualification Standards can be found on IR's Web site.