

查询"553-0133"供应商

LED CBI® Circuit Board Indicator Bi-level

Dialight

553-XXXX

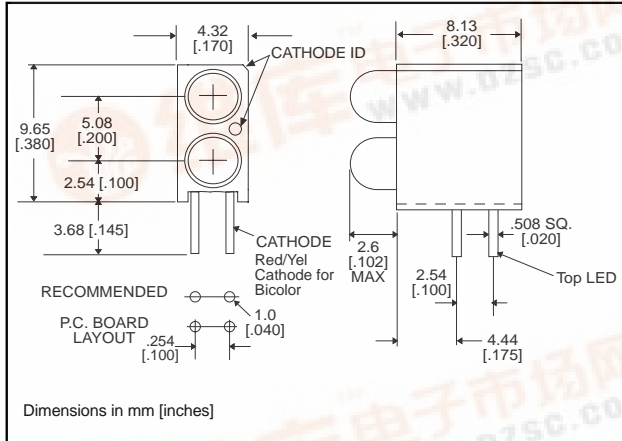

Dimensions in mm [inches]

Standard Polarity shown in drawing: Cathode right

Features

- Multiple CBIs form horizontal LED arrays on 4.45mm (0.175") center-lines. See page 4-41 and 4-42 for pre-assembled arrays
- High Contrast, UL 94 V-0 rated, black housing
- Oxygen index: 32%
- Polymer content: PBT, 0.343 g
- Housing stand-offs facilitate PCB cleaning
- Solderability per MIL-STD-202F, method 208F
- LEDs are safe for direct viewing per IEC 825-1, EN-60825-1

Tolerance note: As noted, otherwise:

- LED Protrusion: ± 0.04 mm [± 0.016]
- CBI Housing: ± 0.02 mm [± 0.008]

Custom Combinations

- Contact factory for information on custom bi-level arrays and color combinations.

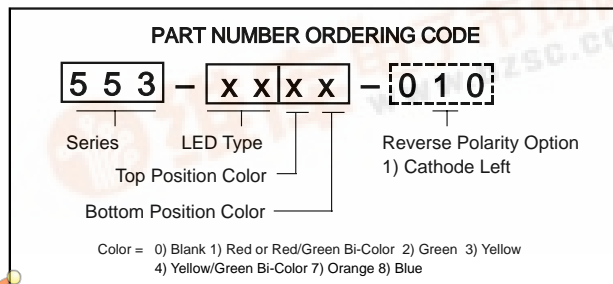

-010 Ordering Code Suffix required ONLY for Reverse Polarity Option

PART NO.

COLOR*

HIGH EFFICIENCY - LED TYPE 01

| | |
|----------|-------------------|
| 553-0111 | Red |
| 553-0122 | Green |
| 553-0133 | Yellow |
| 553-0177 | Orange |
| 553-0188 | Blue ³ |



LOW CURRENT - LED TYPE 02

| | |
|----------|--------|
| 553-0211 | Red |
| 553-0222 | Green |
| 553-0233 | Yellow |

RESISTOR 5 VOLTS - LED TYPE 03

| | |
|----------|--------|
| 553-0311 | Red |
| 553-0322 | Green |
| 553-0333 | Yellow |

BI-COLOR - LED TYPE 07

| | |
|----------|--------------|
| 553-0711 | Red/Green |
| 553-0744 | Yellow/Green |

NON-DIFFUSED - LED TYPE 22

| | |
|----------|--------|
| 553-2211 | Red |
| 553-2222 | Green |
| 553-2233 | Yellow |

* Top-Bottom LED

To order any of the 553-xxxx part numbers with Reverse Polarity (Cathode Left), please add -010 to the part numbers shown above.



ATTENTION
OBSERVE PRECAUTIONS
FOR HANDLING
ELECTROSTATIC
SENSITIVE
DEVICES



[查询"553-0133"供应商](#)Typical Operating Characteristics ($T_A=25^{\circ}\text{C}$)

See LED data sheet for additional information
See page 4-70 and 4-71 for Reference Only LED Drive Circuit Examples. See page 4-72 for Pin Out

HIGH EFFICIENCY

| Part Number | Color | Peak Wavelength nm | I_V mcd | V_F Volts | Test Current (mA) | Viewing Angle $2\theta_{\%}$ | LED Data sheet | Page # |
|-------------|--------|--------------------|-----------|-------------|-------------------|------------------------------|----------------|--------|
| 553-0111 | Red | 650 | 10 | 2 | 10 | 45° | 521-9427 | 4-64 |
| 553-0122 | Green | 563 | 16 | 2.1 | 10 | 45° | 521-9408 | 4-64 |
| 553-0133 | Yellow | 585 | 6.3 | 2.1 | 10 | 45° | 521-9428 | 4-64 |
| 553-0177 | Orange | 600 | 7 | 2.2 | 10 | 60° | 521-9498 | 4-58 |
| 553-0188 | Blue | 428 | 12 | 3.5 | 10 | 70° | 521-9831 | 4-57 |

LOW CURRENT

| Part Number | Color | Peak Wavelength nm | I_V mcd | V_F Volts | Test Current (mA) | Viewing Angle $2\theta_{\%}$ | LED Data sheet | Page # |
|-------------|--------|--------------------|-----------|-------------|-------------------|------------------------------|----------------|--------|
| 553-0211 | Red | 635 | 1.6 | 1.7 | 2 | 60° | 521-9324 | 4-60 |
| 553-0222 | Green | 565 | 1.6 | 1.9 | 2 | 60° | 521-9326 | 4-60 |
| 553-0233 | Yellow | 585 | 1.6 | 1.8 | 2 | 60° | 521-9325 | 4-60 |

INTEGRAL RESISTOR, 5 VOLTS

| Part Number | Color | Peak Wavelength nm | I_V mcd | Test Voltage | Forward Current (mA) | Viewing Angle $2\theta_{\%}$ | LED Data sheet | Page # |
|-------------|--------|--------------------|-----------|--------------|----------------------|------------------------------|----------------|--------|
| 553-0311 | Red | 635 | 29 | 5 | 10 | 60° | 521-9215 | 4-59 |
| 553-0322 | Green | 565 | 19 | 5 | 10 | 60° | 521-9323 | 4-59 |
| 553-0333 | Yellow | 585 | 12.6 | 5 | 10 | 60° | 521-9322 | 4-59 |

BI-COLOR

| Part Number | Color | Peak Wavelength nm | I_V mcd | V_F Volts | Test Current (mA) | Viewing Angle $2\theta_{\%}$ | LED Data sheet | Page # |
|-------------|--------------|--------------------|-----------|-------------|-------------------|------------------------------|----------------|--------|
| 553-0711 | Red/Green | 635/565 | 4.7/10 | 2/2.1 | 10 | 50° | 521-9459 | 4-63 |
| 553-0744 | Yellow/Green | 585/565 | 4.3/6.3 | 2.1*/2.1* | 10 | 80° | 521-9478 | 4-62 |

* $I_F = 20\text{mA}$

NON-DIFFUSED

| Part Number | Color | Peak Wavelength nm | I_V mcd | V_F Volts* | Test Current (mA) | Viewing Angle $2\theta_{\%}$ | LED Data sheet | Page # |
|-------------|--------|--------------------|-----------|--------------|-------------------|------------------------------|----------------|--------|
| 553-2211 | Red | 635 | 29 | 2 | 10 | 45° | 521-9432 | 4-61 |
| 553-2222 | Green | 565 | 50 | 2.1 | 10 | 45° | 521-9430 | 4-61 |
| 553-2233 | Yellow | 585 | 20 | 2.1 | 10 | 45° | 521-9431 | 4-61 |

* $I_F = 20\text{mA}$

CBI ARRAYS .200 PITCH

Dialight offers its Multiarray to reduce insertions and to assure indicator alignment. Multiarrays mount indicators on .200 centers. These assemblies are available in arrays of 2 to 6. See pages 4-41 and 4-42 for information. Call factory for information on .185 pitched arrays.



3mm Discrete LED
Tinted, Diffused

Dialight

521-9831



PART NO. 521-9831
COLOR Blue³

MOUNTING CLIP: 515-0006
located on page 4-65



ATTENTION
OBSERVE PRECAUTIONS
FOR HANDLING
ELECTROSTATIC
SENSITIVE
DEVICES

4

ABSOLUTE MAXIMUM RATINGS (T_A=25°C)

Blue
-9831

| | |
|----------------------------|------------------------------------|
| Power Dissipation (mW) | 100 |
| Forward Current (mA) | 20 |
| Derating (mA/°C) From 55°C | .44 |
| Operating Temperature (°C) | -40/+100 |
| Storage Temperature (°C) | -40/+100 |
| Soldering Temperature | 260°C, 5 seconds, 1.6 mm from case |

Solder Adherence per MIL-STD-202E, Method 208C

OPERATING CHARACTERISTICS (T_A=25°C)

Blue
-9831

| | | |
|--|---------|-----|
| Luminous Intensity (mcd) | Min. | 6.3 |
| I _F =10mA | Typical | 12 |
| Peak Wavelength (nm) | Typical | 428 |
| λ Peak | | |
| Viewing Angle (2Θ _{1/2}) | Typical | 70° |
| Forward Voltage (V) | Typical | 3.5 |
| I _F =10mA | Max. | 4.2 |
| Reverse Voltage (V) I _R =10μA | Min. | 3 |

Θ_{1/2} is the off axis angle at which the luminous intensity is half the axial luminous intensity

3mm Discrete LED

High Efficiency
Diffused

521-9210, -9211, -9216, -9498, -9636

Dialight

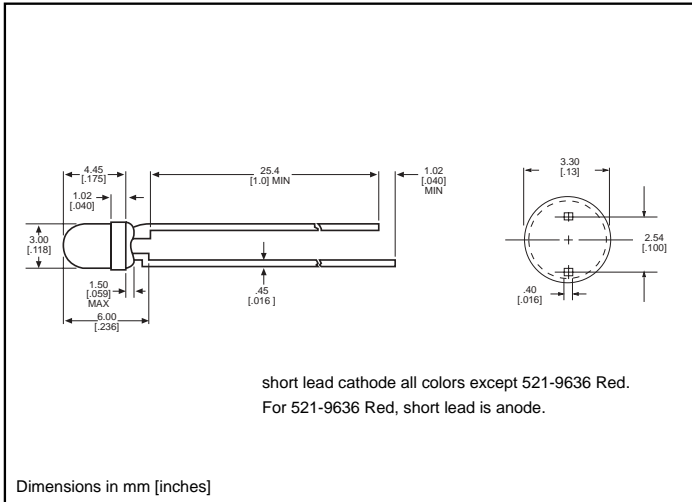

PART NO. COLOR

521-9210 Green
521-9211 Yellow
521-9216 Red
521-9498 Orange
521-9636 Red



MOUNTING CLIP: 515-0006
located on page 4-65

| ABSOLUTE MAXIMUM RATINGS ($T_A=25^\circ\text{C}$) | Green -9210 | Yellow -9211 | Red -9216 | Orange -9498 | Red -9636 |
|--|------------------------------------|------------------------|---------------------|------------------------|---------------------|
| Power Dissipation (mW) | 100 | 60 | 100 | 135 | 100 |
| Forward Current (mA) | 30 | 20 | 30 | 25 | 40 |
| Derating (mA/°C) From 50°C ¹ from 25°C | .4 | .25 | .4 | .5 | .5 ¹ |
| Operating Temperature (°C) | -55/+100 | -55/+100 | -55/+100 | -55/+100 | -55/+100 |
| Storage Temperature (°C) | -55/+100 | -55/+100 | -55/+100 | -55/+100 | -55/+100 |
| Soldering Temperature | 260°C, 5 seconds, 1.6 mm from body | | | | |

Solder Adherence per MIL-STD-202E, Method 208C

| OPERATING CHARACTERISTICS ($T_A=25^\circ\text{C}$) | | Green -9210 | Yellow -9211 | Red -9216 | Orange -9498 | Red -9636 |
|---|---------|-----------------------|------------------------|---------------------|------------------------|---------------------|
| Luminous Intensity (mcd) | Min. | 4.7 | 7.4 | 7.4 | 3.4 | 8.7 ¹ |
| | Typical | 12.6 | 10 | 10 | 7 | 48 ¹ |
| Peak Wavelength (nm) | Typical | 565 | 585 | 635 | 600 | 660 |
| Viewing Angle (2θ °) | Typical | 60° | 60° | 60° | 60° | 60° |
| Forward Voltage (V) | Typical | 2.1 ¹ | 2.1 ¹ | 2 ¹ | 2.2 | 1.8 ¹ |
| | Max. | 2.8 ¹ | 2.8 ¹ | 2.8 ¹ | 3 | 2.4 ¹ |
| Reverse Voltage (V), $I_R=100\mu\text{A}$ | Max. | 5 | 5 | 5 | 5 | 4 |

¹ θ is the off axis angle at which the luminous intensity is half the axial luminous intensity

3mm Discrete LED

Integral Resistor, 5V
Diffused

Dialight

521-9215, -9322, -9323

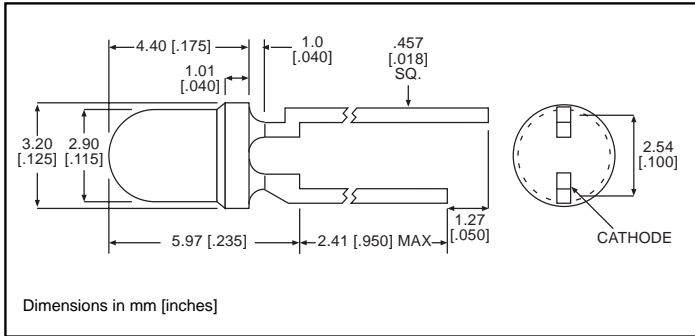

| PART NO. | COLOR |
|----------|--------|
| 521-9215 | Red |
| 521-9322 | Yellow |
| 521-9323 | Green |

MOUNTING CLIP: 515-0006
located on page 4-65

ABSOLUTE MAXIMUM RATINGS ($T_A=25^\circ\text{C}$)

| | Red -9215 | Yellow -9322 | Green -9323 |
|---|--|-----------------|----------------|
| Forward Voltage (V) | 7.5 | 7.5 | 7.5 |
| Derating ($V/^\circ\text{C}$) From 50°C | .086 | .086 | .071 |
| Operating Temperature ($^\circ\text{C}$) | -40/+85 | -40/+85 | -20/+85 |
| Storage Temperature ($^\circ\text{C}$) | -55/+100 | -55/+100 | -55/+100 |
| Soldering Temperature | 260 $^\circ\text{C}$, 5 seconds, 1.6 mm from case | | |

Solder Adherence per MIL-STD-202E, Method 208C

OPERATING CHARACTERISTICS ($T_A=25^\circ\text{C}$)

| | | Red -9215 | Yellow -9322 | Green -9323 |
|---|---------|--------------|-----------------|----------------|
| Luminous Intensity (mcd) | Min. | 8.7 | 3.7 | 5.6 |
| | Typical | 29 | 12.6 | 19 |
| Peak Wavelength (nm) | Typical | 635 | 585 | 565 |
| Viewing Angle ($2\theta_{1/2}$) | Typical | 60 $^\circ$ | 60 $^\circ$ | 60 $^\circ$ |
| Forward Current (mA) | Typical | 10 | 10 | 10 |
| | Max. | 20 | 20 | 20 |
| Reverse Voltage (V), $I_R=100\mu\text{A}$ | Min. | 5 | 5 | 5 |

$\theta_{1/2}$ is the off axis angle at which the luminous intensity is half the axial luminous intensity

4

3mm Discrete LED

Low Current
Diffused

Dialight

521-9324, -9325, -9326

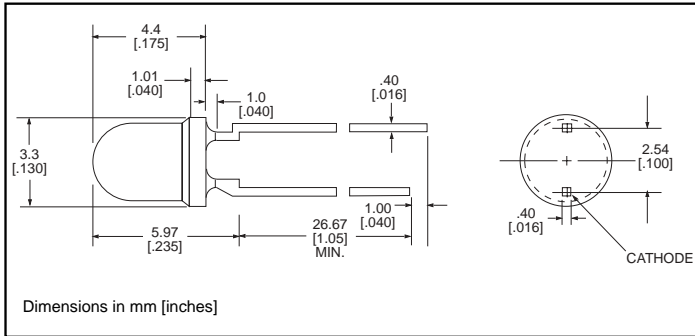

| PART NO. | COLOR |
|----------|--------|
| 521-9324 | Red |
| 521-9325 | Yellow |
| 521-9326 | Green |

MOUNTING CLIP: 515-0006
located on page 4-65

ABSOLUTE MAXIMUM RATINGS (T_A=25°C)

| | Red -9324 | Yellow -9325 | Green -9326 |
|--|------------------------------------|-----------------|----------------|
| Power Dissipation (mW) | 20 | 20 | 20 |
| Forward Current (mA) | 7 | 7 | 7 |
| Derating (mA/°C) From 90°C | .7 | .7 | .7 |
| Peak Current (mA) Pulse width = 10 μs | 500 | 500 | 500 |
| Operating Temperature (°C) | -55/+100 | -55/+100 | -55/+100 |
| Storage Temperature (°C) | -55/+100 | -55/+100 | -55/+100 |
| Soldering Temperature | 260°C, 5 seconds, 1.6 mm from case | | |

Solder Adherence per MIL-STD-202E, Method 208C

OPERATING CHARACTERISTICS (T_A=25°C)

| | | Red -9324 | Yellow -9325 | Green -9326 |
|---|---------|--------------|-----------------|----------------|
| Luminous Intensity (mcd) I _F =2mA | Min. | 1 | 1 | 1 |
| | Typical | 1.6 | 1.6 | 1.6 |
| Peak Wavelength (nm) λ _{Peak} | Typical | 635 | 585 | 565 |
| Viewing Angle (2Θ ^{1/2}) | Typical | 60° | 60° | 60° |
| Forward Voltage (V) I _F =2mA | Typical | 1.7 | 1.8 | 1.9 |
| | Max. | 2.2 | 2.7 | 2.2 |
| Reverse Voltage (V), I _R =50μA | Min. | 5 | 5 | 5 |

Θ^{1/2} is the off axis angle at which the luminous intensity is half the axial luminous intensity

查询"552-0193"供应商

3mm Discrete LED
High Efficiency
Tinted, Non-Diffused



521-9430, -9431, -9432

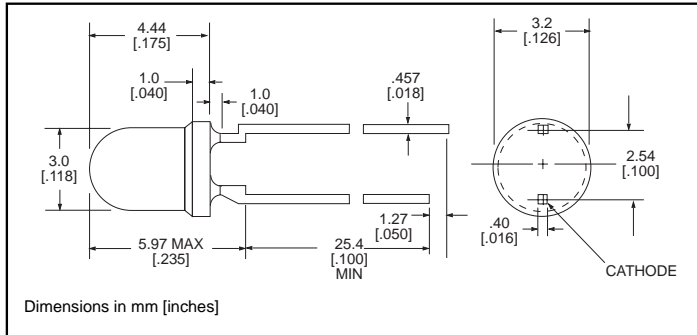

| PART NO. | COLOR |
|----------|--------|
| 521-9430 | Green |
| 521-9431 | Yellow |
| 521-9432 | Red |

MOUNTING CLIP: 515-0006
 located on page 4-65

ABSOLUTE MAXIMUM RATINGS ($T_A=25^\circ\text{C}$)

| | Green -9430 | Yellow -9431 | Red -9432 |
|--|------------------------------------|------------------------|---------------------|
| Power Dissipation (mW) | 100 | 60 | 100 |
| Forward Current (mA) | 30 | 20 | 30 |
| Derating (mA/°C) From 50°C | .4 | .25 | .4 |
| Peak Current (mA) Pulse width = 100µs | 120 | 80 | 120 |
| Operating Temperature (°C) | -55/+100 | -55/+100 | -55/+100 |
| Storage Temperature (°C) | -55/+100 | -55/+100 | -55/+100 |
| Soldering Temperature | 260°C, 5 seconds, 1.6 mm from case | | |

Solder Adherence per MIL-STD-202E, Method 208C

OPERATING CHARACTERISTICS ($T_A=25^\circ\text{C}$)

| | | Green -9430 | Yellow -9431 | Red -9432 |
|---|---------|-----------------------|------------------------|---------------------|
| Luminous Intensity (mcd) $I_F=10\text{mA}$ | Min. | 32 | 10 | 8.7 |
| | Typical | 50 | 20 | 29 |
| Peak Wavelength (nm) λ Peak | Typical | 565 | 585 | 635 |
| Viewing Angle ($2\theta_{1/2}$) | Typical | 45° | 45° | 45° |
| Forward Voltage (V) $I_F=20\text{mA}$ | Typical | 2.1 | 2.1 | 2 |
| | Max. | 2.8 | 2.8 | 2.8 |

$\theta_{1/2}$ is the off axis angle at which the luminous intensity is half the axial luminous intensity

4

3mm Discrete LED

Bi-Color
Non-Tinted, Diffused



521-9478, -9628, -9768

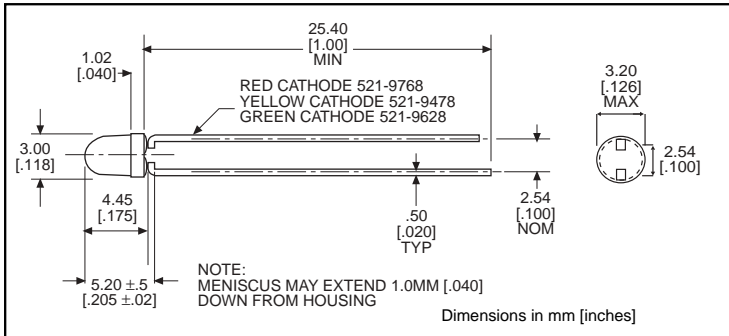

| PART NO. | COLOR |
|----------|--------------|
| 521-9478 | Yellow/Green |
| 521-9628 | Red/Green |
| 521-9768 | Red/Yellow |

MOUNTING CLIP: 515-0006
located on page 4-65

| ABSOLUTE MAXIMUM RATINGS (T _A =25°C) | Yellow/Green | Red/Green | Red/Yellow |
|---|-------------------------------------|-----------|-----------------------------------|
| | -9478 | -9628 | -9768 |
| Power Dissipation (mW) | 60/100 | 140/100 | 100/60 |
| Forward Current (mA) | 20/30 | 40/30 | 30/20 |
| Derating (mA/°C) From 25°C 1 From 50°C | .25 ¹ /.40 ¹ | .5/.4 | .4 ¹ /.25 ¹ |
| Peak Current (mA) Pulse width = 10µs | 80/120 | 200/120 | 120/80 |
| Operating Temperature (°C) | -55/+100 | -55/+100 | -55/+100 |
| Storage Temperature (°C) | -55/+100 | -55/+100 | -55/+100 |
| Soldering Temperature | 260°C, 5 seconds, 1.66 mm from case | | |

Solder Adherence per MIL-STD-202E, Method 208C

| OPERATING CHARACTERISTICS (T _A =25°C) | | Yellow/Green | Red/Green | Red/Yellow |
|--|---------|--------------|------------|------------|
| | | -9478 | -9628 | -9768 |
| Luminous Intensity (mcd) | Min. | 2.5/2.5 | 3.7*/1.1* | 1.7*/1.7* |
| | Typical | 4.3/6.3 | 12.6*/3.7* | 5.6*/5.6* |
| Peak Wavelength (nm) | Typical | 585/565 | 660/565 | 630/585 |
| Viewing Angle (2θ ^½) | Typical | 80° | 200° | 80° |
| Forward Voltage (V) | Typical | 2.1/2.1 | 1.8/2.1 | 2/2.1 |
| | Max. | 2.8/2.8 | 2.4/2.8 | 2.8/2.8 |
| Reverse Voltage (V) | Min. | 5 | 5 | 5 |

θ¹ is the off axis angle at which the luminous intensity is half the axial luminous intensity

查询:551-0113 供应商

3mm Discrete LED
Bi-Color
Non-Tinted, Diffused



521-9459

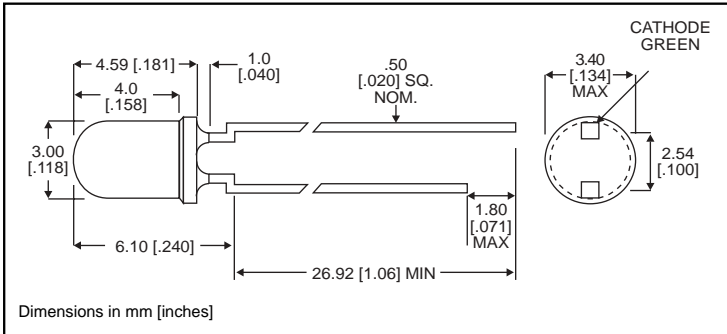

PART NO. 521-9459
COLOR Red/Green

MOUNTING CLIP: 515-0006
 located on page 4-65

ABSOLUTE MAXIMUM RATINGS ($T_A=25^\circ\text{C}$)

Red/Green
-9459

| | |
|----------------------------|------------------------------------|
| Power Dissipation (mW) | 140 |
| Forward Current (mA) | 45 |
| Derating (mA/°C) From 25°C | .6 |
| Peak Current (mA) | 1000 |
| Pulse width = 10µs | |
| Operating Temperature (°C) | -55/+100 |
| Storage Temperature (°C) | -55/+100 |
| Soldering Temperature | 260°C, 5 seconds, 1.6 mm from case |

Solder Adherence per MIL-STD-202E, Method 208C

OPERATING CHARACTERISTICS ($T_A=25^\circ\text{C}$)

Red/Green
-9459

| | | |
|-----------------------------------|---------|---------|
| Luminous Intensity (mcd) | Min. | 2.5/3.7 |
| $I_F=10\text{mA}$ | Typical | 4.7/10 |
| Peak Wavelength (nm) | Typical | 635/565 |
| λ Peak | | |
| Viewing Angle ($2\theta_{1/2}$) | Typical | 50° |
| Forward Voltage (V) | Typical | 2/2.1 |
| $I_F=10\text{mA}$ | Max. | 2.8/2.8 |

$\theta_{1/2}$ is the off axis angle at which the luminous intensity is half the axial luminous intensity

3mm Discrete LED
High Efficiency
Diffused

Dialight

521-94xx



TYPE
521-9408
521-9427
521-9428

COLOR
Green
Red
Yellow

MOUNTING CLIP: 515-0006
located on page 4-65

ABSOLUTE MAXIMUM RATINGS ($T_A=25^\circ\text{C}$)

| | Green -9408 | Red -9427 | Yellow -9428 |
|-----------------------------------|------------------------------------|---------------------|------------------------|
| Power Dissipation (mW) | 75 | 60 | 60 |
| Forward Current (mA) | 25 | 20 | 20 |
| Derating (mA/°C) <i>From 50°C</i> | .5 | .5 | .5 |
| Peak Current (mA) | 60 | 60 | 60 |
| Operating Temperature (°C) | -25/+85 | -25/+85 | -25/+85 |
| Storage Temperature (°C) | -30/+100 | -30/+100 | -30/+100 |
| Soldering Temperature | 260°C, 5 seconds, 1.6 mm from case | | |

Solder Adherence per MIL-STD-202E, Method 208C

OPERATING CHARACTERISTICS ($T_A=25^\circ\text{C}$)

| | | Green -9408 | Red -9427 | Yellow -9428 |
|--|---------|-----------------------|---------------------|------------------------|
| Luminous Intensity (mcd) | Min. | 5.6 | 3.6 | 2.2 |
| | Typical | 16 | 10 | 6.3 |
| Peak Wavelength (nm) | Typical | 563 | 650 | 585 |
| Viewing Angle ($2\theta^{1/2}$) | Typical | 45° | 45° | 45° |
| Forward Voltage (V) | Typical | 2.1 | 2 | 2.1 |
| | Max. | 3 | 3 | 3 |
| Reverse Voltage (V), $I_R=10\mu\text{A}$ | Min. | 3 | 3 | 3 |

$\theta^{1/2}$ is the off axis angle at which the luminous intensity is half the axial luminous intensity