

ST 2SC4672U

[查询"2SC4672U"供应商](#)

NPN Silicon Epitaxial Planar Transistor

Low Frequency Transistor

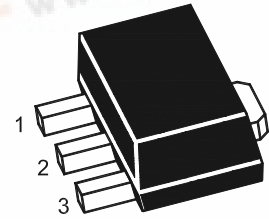

1.Base 2.Collector 3.Emitter
SOT-89 Plastic Package

Absolute Maximum Ratings ($T_a = 25\text{ }^\circ\text{C}$)

Parameter	Symbol	Value	Unit
Collector Base Voltage	V_{CBO}	60	V
Collector Emitter Voltage	V_{CEO}	50	V
Emitter Base Voltage	V_{EBO}	6	V
Collector Current - DC	I_C	3	A
Collector Current - Pulse ¹⁾	I_{CP}	6	A
Total Power Dissipation	P_{tot}	0.5 2 ²⁾	W
Junction Temperature	T_J	150	$^\circ\text{C}$
Storage Temperature Range	T_S	- 55 to + 150	$^\circ\text{C}$

¹⁾ Single pulse, PW = 10 ms.

²⁾ When mounted on a 40 X 40 X 0.7 mm ceramic board.

Characteristics at $T_a = 25\text{ }^\circ\text{C}$

Parameter	Symbol	Min.	Typ.	Max.	Unit
DC Current Gain at $V_{CE} = 2\text{ V}$, $I_C = 0.5\text{ A}$ at $V_{CE} = 2\text{ V}$, $I_C = 1.5\text{ A}$	h_{FE} h_{FE}	82 45	- -	270 -	- -
Collector Base Breakdown Voltage at $I_C = 50\text{ }\mu\text{A}$	$V_{(BR)CBO}$	60	-	-	V
Collector Emitter Breakdown Voltage at $I_C = 1\text{ mA}$	$V_{(BR)CEO}$	50	-	-	V
Emitter Base Breakdown Voltage at $I_E = 50\text{ }\mu\text{A}$	$V_{(BR)EBO}$	6	-	-	V
Collector Cutoff Current at $V_{CB} = 60\text{ V}$	I_{CBO}	-	-	0.1	μA
Emitter Cutoff Current at $V_{EB} = 5\text{ V}$	I_{EBO}	-	-	0.1	μA
Collector Emitter Saturation Voltage at $I_C = 1\text{ A}$, $I_B = 50\text{ mA}$	$V_{CE(sat)}$	-	-	0.35	V
Transition Frequency at $V_{CE} = 5\text{ V}$, $-I_E = 0.5\text{ A}$, $f = 100\text{ MHz}$	f_T	-	210	-	MHz
Output Capacitance at $V_{CB} = 10\text{ V}$, $f = 1\text{ MHz}$	C_{ob}	-	25	-	pF

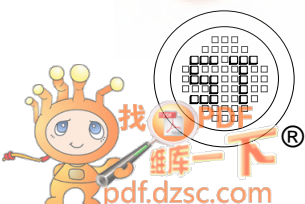

SEMTECH ELECTRONICS LTD.

(Subsidiary of Sino-Tech International Holdings Limited, a company
listed on the Hong Kong Stock Exchange, Stock Code: 724)



Dated : 06/12/2006

ST 2SC4672U

查询"2SC4672U"供应商

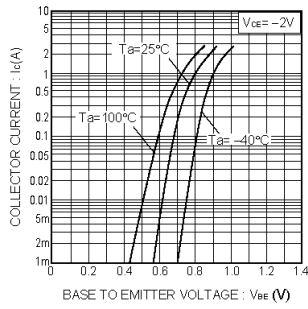

Fig.1 Grounded emitter propagation characteristics

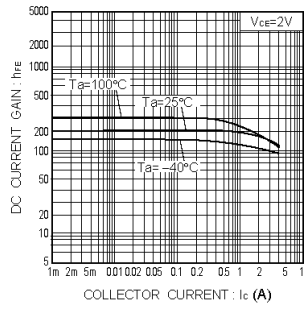

Fig.2 DC current gain vs. collector current

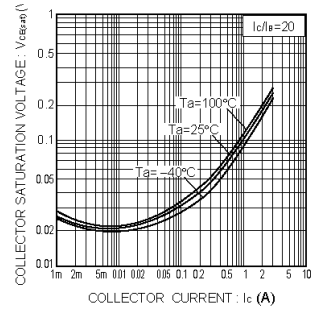

Fig.3 Collector-emitter saturation voltage vs. collector current

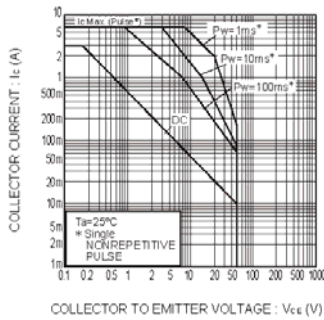
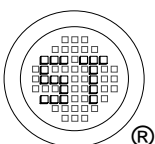

Fig.4 Safe Operating area



SEMTECH ELECTRONICS LTD.

(Subsidiary of Sino-Tech International Holdings Limited, a company listed on the Hong Kong Stock Exchange, Stock Code: 724)



ISO/TS 16949 : 2002
Certificate No. 05103



ISO 14001:2004
Certificate No. 71116



ISO 9001:2000
Certificate No. 0506098

ST 2SC4672U

[查询"2SC4672U"供应商](#)

SOT-89 PACKAGE OUTLINE

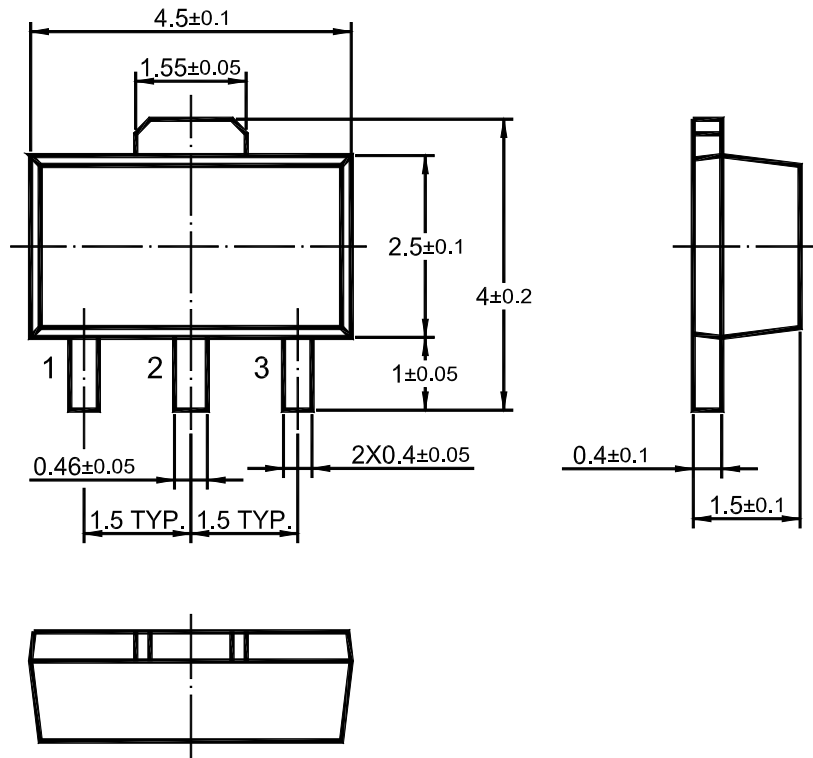

Dimensions in mm

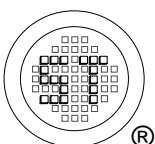

SEMTECH ELECTRONICS LTD.

(Subsidiary of Sino-Tech International Holdings Limited, a company listed on the Hong Kong Stock Exchange, Stock Code: 724)



Dated : 06/12/2006