

查询"74HCT4046AD-T"供应商

PHASE LOCKED LOOP WITH VCO

FEATURES

- Low power consumption
- Centre frequency of up to 17 MHz (typ.) at  $V_{CC} = 4.5 V$
- Choice of three phase comparators: EXCLUSIVE-OR; edge-triggered JK flip-flop; edge-triggered RS flip-flop
- Excellent VCO frequency linearity
- VCO-inhibit control for ON/OFF keying and for low standby power consumption
- Minimal frequency drift
- Operating power supply voltage range: VCO section 3.0 to 6.0 V digital section 2.0 to 6.0 V
- Zero voltage offset due to op-amp buffering
- Output capability: standard
- $I_{CC}$  category: MSI

SYMBOL	PARAMETER	CONDITIONS	TYPICAL		UNIT
			HC	HCT	
$f_o$	VCO centre frequency	$C_1 = 40 \text{ pF}$ $R_1 = 3 \text{ k}\Omega$ $V_{CC} = 5 V$	19	19	MHz
$C_I$	input capacitance (pin 5)		3.5	3.5	pF
CPD	power dissipation capacitance per package	notes 1 and 2	24	24	pF

$GND = 0 V$ ;  $T_{amb} = 25^\circ C$

Notes

1. CPD is used to determine the dynamic power dissipation ( $P_D$  in  $\mu W$ ):

$$P_D = CPD \times V_{CC}^2 \times f_i + \sum (C_L \times V_{CC}^2 \times f_o) \text{ where:}$$

$f_i$  = input frequency in MHz       $C_L$  = output load capacitance in pF  
 $f_o$  = output frequency in MHz       $V_{CC}$  = supply voltage in V  
 $\sum (C_L \times V_{CC}^2 \times f_o)$  = sum of outputs

2. Applies to the phase comparator section only (VCO disabled).  
 For power dissipation of the VCO and demodulator sections see Figs 22, 23 and 24.

PACKAGE OUTLINES

16-lead DIL; plastic (SOT38Z).  
 16-lead mini-pack; plastic (SO16; SOT109A).

GENERAL DESCRIPTION

The 74HC/HCT4046A are high-speed Si-gate CMOS devices and are pin compatible with the "4046" of the "4000B" series. They are specified in compliance with JEDEC standard no. 7A. The 74HC/HCT4046A are phase-locked-loop circuits that comprise a linear voltage-controlled oscillator (VCO) and three different phase comparators (PC1, PC2 and PC3) with a common signal input amplifier and a common comparator input.

The signal input can be directly coupled to large voltage signals, or indirectly coupled (with a series capacitor) to small voltage signals. A self-bias input circuit keeps small voltage signals within the linear region of the input amplifiers. With a passive low-pass filter, the "4046A" forms a second-order loop PLL. The excellent VCO linearity is achieved by the use of linear op-amp techniques.

(continued on next page)

APPLICATIONS

- FM modulation and demodulation
- Frequency synthesis and multiplication
- Frequency discrimination
- Tone decoding
- Data synchronization and conditioning
- Voltage-to-frequency conversion
- Motor-speed control

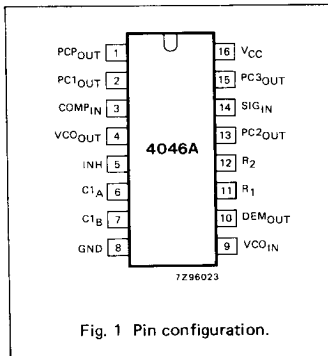

Fig. 1 Pin configuration.

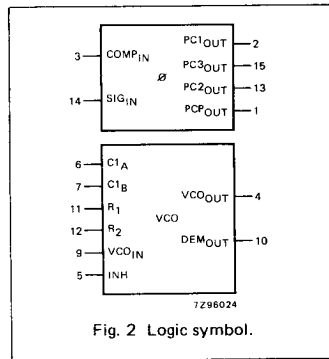

Fig. 2 Logic symbol.

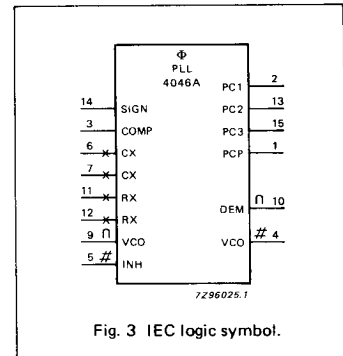

Fig. 3 IEC logic symbol.

查询"74HCT4046AD-T"供应商

PIN DESCRIPTION

PIN NO.	SYMBOL	NAME AND FUNCTION
1	PC <sub>1</sub> OUT	phase comparator pulse output
2	PC <sub>1</sub> OUT	phase comparator 1 output
3	COMP <sub>1</sub> N	comparator input
4	VCO <sub>OUT</sub>	VCO output
5	INH	inhibit input
6	C <sub>1</sub> A	capacitor C1 connection A
7	C <sub>1</sub> B	capacitor C1 connection B
8	GND	ground (0 V)
9	VCO <sub>IN</sub>	VCO input
10	DEM <sub>OUT</sub>	demodulator output
11	R <sub>1</sub>	resistor R1 connection
12	R <sub>2</sub>	resistor R2 connection
13	PC <sub>2</sub> OUT	phase comparator 2 output
14	SIG <sub>1</sub> N	signal input
15	PC <sub>3</sub> OUT	phase comparator 3 output
16	V <sub>CC</sub>	positive supply voltage

VCO output signal has a duty factor of 50% (maximum expected deviation 1%), if the VCO input is held at a constant DC level. A LOW level at the inhibit input (INH) enables the VCO and demodulator, while a HIGH level turns both off to minimize standby power consumption.

The only difference between the HC and HCT versions is the input level specification of the INH input. This input disables the VCO section. The sections of the comparator are identical, so that there is no difference in the SIG<sub>1</sub>N (pin 14) or COMP<sub>1</sub>N (pin 3) inputs between the HC and HCT versions.

Phase comparators

The signal input (SIG<sub>1</sub>N) can be directly coupled to the self-biasing amplifier at pin 14, provided that the signal swing is between the standard HC family input logic levels. Capacitive coupling is required for signals with smaller swings.

Phase comparator 1 (PC1)

This is an EXCLUSIVE-OR network. The signal and comparator input frequencies ( $f_i$ ) must have a 50% duty factor to obtain the maximum locking range. The transfer characteristic of PC1, assuming ripple ( $f_r = 2f_i$ ) is suppressed, is:

$$V_{DEMOUT} = \frac{V_{CC}}{\pi} (\phi_{SIGIN} - \phi_{COMPIN})$$

where  $V_{DEMOUT}$  is the demodulator output at pin 10;

$V_{DEMOUT} = V_{PC1OUT}$  (via low-pass filter).

GENERAL DESCRIPTION (Cont'd)  
VCO

The VCO requires one external capacitor C1 (between C<sub>1</sub>A and C<sub>1</sub>B) and one external resistor R1 (between R<sub>1</sub> and GND) or two external resistors R1 and R2 (between R<sub>1</sub> and GND, and R<sub>2</sub> and GND). Resistor R1 and capacitor C1 determine the frequency range of the VCO. Resistor R2 enables the VCO to have a frequency offset if required.

The high input impedance of the VCO simplifies the design of low-pass filters by giving the designer a wide choice of

resistor/capacitor ranges. In order not to load the low-pass filter, a demodulator output of the VCO input voltage is provided at pin 10 (DEM<sub>OUT</sub>). In contrast to conventional techniques where the DEM<sub>OUT</sub> voltage is one threshold voltage lower than the VCO input voltage, here the DEM<sub>OUT</sub> voltage equals that of the VCO input. If DEM<sub>OUT</sub> is used, a load resistor (R<sub>S</sub>) should be connected from DEM<sub>OUT</sub> to GND; if unused, DEM<sub>OUT</sub> should be left open. The VCO output (VCO<sub>OUT</sub>) can be connected directly to the comparator input (COMP<sub>1</sub>N), or connected via a frequency-divider. The

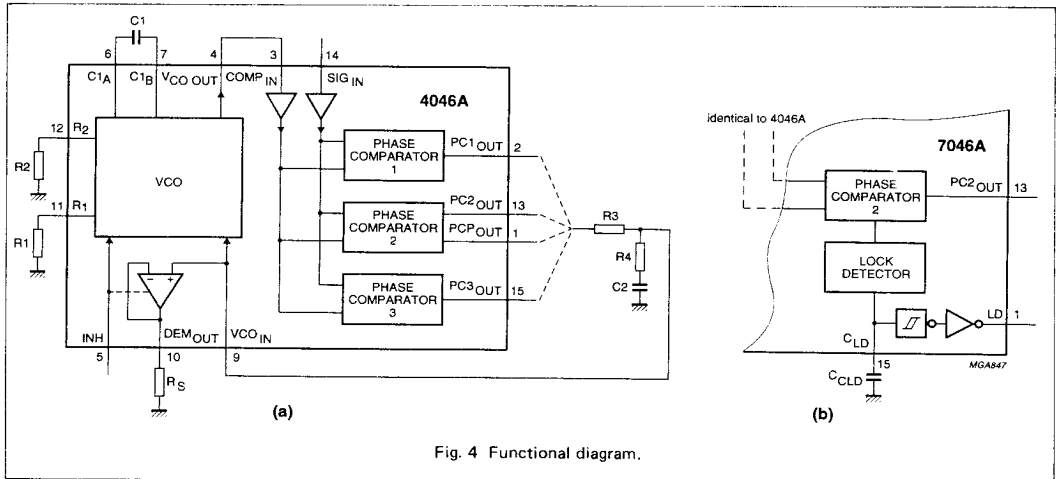

Fig. 4 Functional diagram.

查询"74HCT4046AD-T"供应商

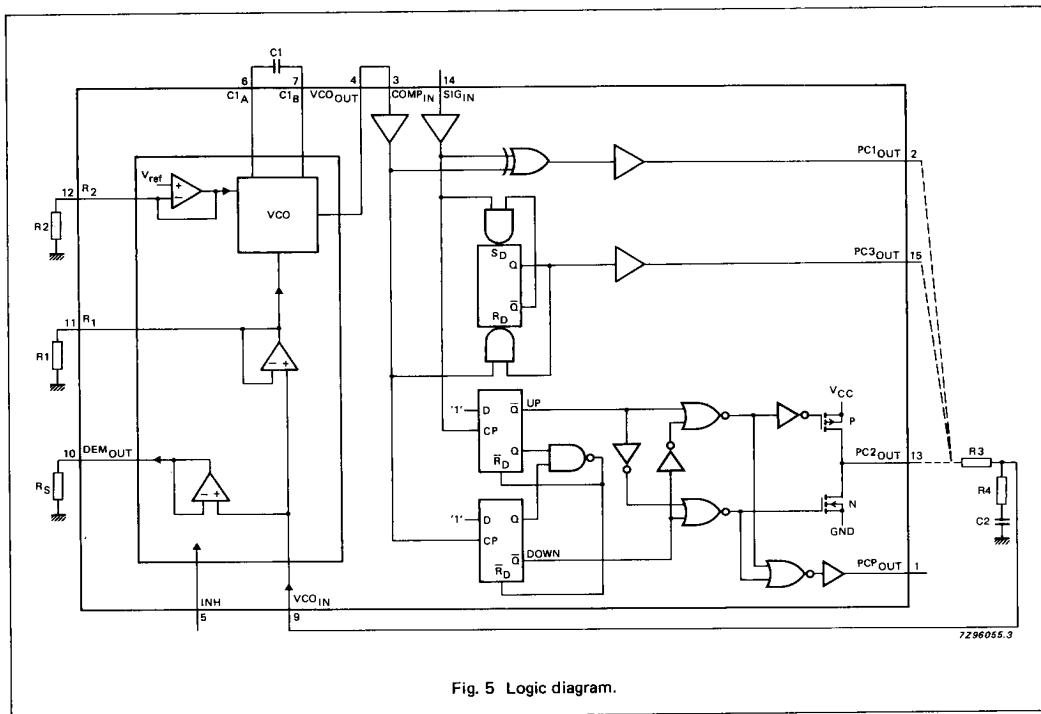

Fig. 5 Logic diagram.

The phase comparator gain is:

$$K_p = \frac{V_{CC}}{\pi} \text{ (V/r)}.$$

The average output voltage from PC1, fed to the VCO input via the low-pass filter and seen at the demodulator output at pin 10 ( $V_{DEMOUT}$ ), is the resultant of the phase differences of signals ( $SIG_{IN}$ ) and the comparator input ( $COMP_{IN}$ ) as shown in Fig. 6. The average of  $V_{DEMOUT}$  is equal to  $1/2 V_{CC}$  when there is no signal or noise at  $SIG_{IN}$  and with this input the VCO oscillates at the centre frequency ( $f_0$ ). Typical waveforms for the PC1 loop locked at  $f_0$  are shown in Fig. 7.

The frequency capture range ( $2f_c$ ) is defined as the frequency range of input signals on which the PLL will lock if it was initially out-of-lock. The frequency lock range ( $2f_L$ ) is defined as the frequency range of input signals on which the loop will stay locked if it was initially in lock. The capture range is smaller or equal to the lock range.

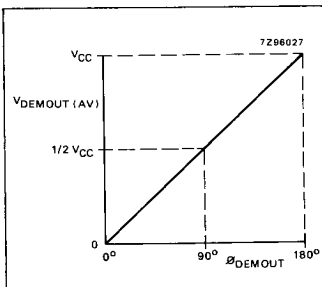

Fig. 6 Phase comparator 1: average output voltage versus input phase difference:

$$V_{DEMOUT} = V_{PC1OUT} =$$

$$\frac{V_{CC}}{\pi} (\phi_{SIGIN} - \phi_{COMPIN})$$

$$\phi_{DEMOUT} = (\phi_{SIGIN} - \phi_{COMPIN}).$$

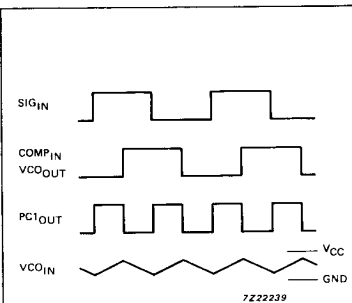

Fig. 7 Typical waveforms for PLL using phase comparator 1, loop locked at  $f_0$ .

## 查询"74HCT4046AD-T"供应商

### GENERAL DESCRIPTION (Cont'd)

#### Phase comparators (Cont'd)

With PC1, the capture range depends on the low-pass filter characteristics and can be made as large as the lock range. This configuration retains lock even with very noisy input signals. Typical behaviour of this type of phase comparator is that it can lock to input frequencies close to the harmonics of the VCO centre frequency.

#### Phase comparator 2 (PC2)

This is a positive edge-triggered phase and frequency detector. When the PLL is using this comparator, the loop is controlled by positive signal transitions and the duty factors of SIG<sub>IN</sub> and COMP<sub>IN</sub> are not important. PC2 comprises two D-type flip-flops, control-gating and a 3-state output stage. The circuit functions as an up-down counter (Fig. 5) where SIG<sub>IN</sub> causes an up-count and COMP<sub>IN</sub> a down-count. The transfer function of PC2, assuming ripple ( $f_r = f_i$ ) is suppressed, is:

$$V_{\text{DEMOUT}} = \frac{V_{\text{CC}}}{4\pi} (\phi_{\text{SIGIN}} - \phi_{\text{COMPIN}})$$

where  $V_{\text{DEMOUT}}$  is the demodulator output at pin 10;

$V_{\text{DEMOUT}} = V_{\text{PC2OUT}}$  (via low-pass filter).

The phase comparator gain is:

$$K_p = \frac{V_{\text{CC}}}{4\pi} (V/r).$$

$V_{\text{DEMOUT}}$  is the resultant of the initial phase differences of SIG<sub>IN</sub> and COMP<sub>IN</sub> as shown in Fig. 8. Typical waveforms for the PC2 loop locked at  $f_0$  are shown in Fig. 9.

When the frequencies of SIG<sub>IN</sub> and COMP<sub>IN</sub> are equal but the phase of SIG<sub>IN</sub> leads that of COMP<sub>IN</sub>, the p-type output driver at PC2OUT is held "ON" for a time corresponding to the phase difference ( $\phi_{\text{DEMOUT}}$ ). When the phase of SIG<sub>IN</sub> lags that of COMP<sub>IN</sub>, the n-type driver is held "ON".

When the frequency of SIG<sub>IN</sub> is higher than that of COMP<sub>IN</sub>, the p-type output driver is held "ON" for most of the input signal cycle time, and for the remainder of the cycle both n and p-type drivers are "OFF" (3-state). If the SIG<sub>IN</sub> frequency

is lower than the COMP<sub>IN</sub> frequency, then it is the n-type driver that is held "ON" for most of the cycle. Subsequently, the voltage at the capacitor (C2) of the low-pass filter connected to PC2OUT varies until the signal and comparator inputs are equal in both phase and frequency. At this stable point the voltage on C2 remains constant as the PC2 output is in 3-state and the VCO input at pin 9 is a high impedance. Also in this condition, the signal at the phase comparator pulse output (PCPOUT) is a HIGH level and so can be used for indicating a locked condition.

Thus, for PC2, no phase difference exists between SIG<sub>IN</sub> and COMP<sub>IN</sub> over the full frequency range of the VCO. Moreover, the power dissipation due to the low-pass filter is reduced because both p and n-type drivers are "OFF" for most of the signal input cycle. It should be noted that the PLL lock range for this type of phase comparator is equal to the capture range and is independent of the low-pass filter. With no signal present at SIG<sub>IN</sub> the VCO adjusts, via PC2, to its lowest frequency.

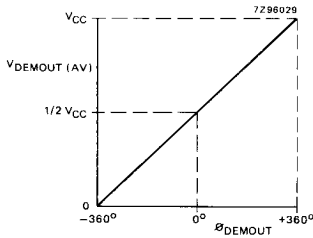

Fig. 8 Phase comparator 2: average output voltage versus input phase difference:

$$V_{\text{DEMOUT}} = V_{\text{PC2OUT}} =$$

$$\frac{V_{\text{CC}}}{4\pi} (\phi_{\text{SIGIN}} - \phi_{\text{COMPIN}})$$

$$\phi_{\text{DEMOUT}} = (\phi_{\text{SIGIN}} - \phi_{\text{COMPIN}}).$$

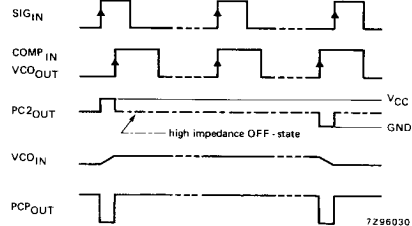

Fig. 9 Typical waveforms for PLL using phase comparator 2, loop locked at  $f_0$ .

## 查询"74HCT4046AD-T"供应商

### Phase comparator 3 (PC3)

This is a positive edge-triggered sequential phase detector using an RS-type flip-flop. When the PLL is using this comparator, the loop is controlled by positive signal transitions and the duty factors of SIG<sub>IN</sub> and COMP<sub>IN</sub> are not important. The transfer characteristic of PC3, assuming ripple ( $f_r = f_i$ ) is suppressed, is:

$$V_{\text{DEMOUT}} = \frac{V_{\text{CC}}}{2\pi} (\phi_{\text{SIGIN}} - \phi_{\text{COMPIN}})$$

where  $V_{\text{DEMOUT}}$  is the demodulator output at pin 10;

$V_{\text{DEMOUT}} = V_{\text{PC3OUT}}$  (via low-pass filter).

The phase comparator gain is:

$$K_p = \frac{V_{\text{CC}}}{2\pi} (V/r).$$

The average output from PC3, fed to the VCO via the low-pass filter and seen at the demodulator output at pin 10 ( $V_{\text{DEMOUT}}$ ), is the resultant of the phase differences of SIG<sub>IN</sub> and COMP<sub>IN</sub> as shown in Fig. 10. Typical waveforms for the PC3 loop locked at  $f_0$  are shown in Fig. 11.

The phase-to-output response characteristic of PC3 (Fig. 10) differs from that of PC2 in that the phase angle between SIG<sub>IN</sub> and COMP<sub>IN</sub> varies between  $0^\circ$  and  $360^\circ$  and is  $180^\circ$  at the

centre frequency. Also PC3 gives a greater voltage swing than PC2 for input phase differences but as a consequence the ripple content of the VCO input signal is higher. The PLL lock range for this type of phase comparator and the capture range are dependent on the low-pass filter. With no signal present at SIG<sub>IN</sub> the VCO adjusts, via PC3, to its lowest frequency.

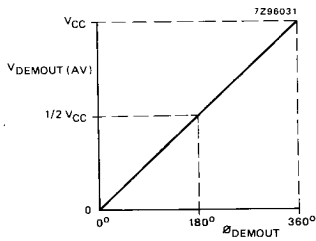

Fig. 10 Phase comparator 3: average output voltage versus input phase difference:

$$V_{\text{DEMOUT}} = V_{\text{PC3OUT}} =$$

$$\frac{V_{\text{CC}}}{2\pi} (\phi_{\text{SIGIN}} - \phi_{\text{COMPIN}})$$

$$\phi_{\text{DEMOUT}} = (\phi_{\text{SIGIN}} - \phi_{\text{COMPIN}}).$$

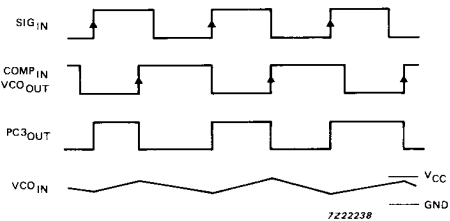

Fig. 11 Typical waveforms for PLL using phase comparator 3, loop locked at  $f_0$ .

[查询"74HCT4046AD-T"供应商](#)

RECOMMENDED OPERATING CONDITIONS FOR 74HC/HCT

SYMBOL	PARAMETER	74HC			74HCT			UNIT	CONDITIONS
		min.	typ.	max.	min.	typ.	max.		
V <sub>CC</sub>	DC supply voltage	3.0	5.0	6.0	4.5	5.0	5.5	V	
V <sub>CC</sub>	DC supply voltage if VCO section is not used	2.0	5.0	6.0	4.5	5.0	5.5	V	
V <sub>I</sub>	DC input voltage range	0		V <sub>CC</sub>	0		V <sub>CC</sub>	V	
V <sub>O</sub>	DC output voltage range	0		V <sub>CC</sub>	0		V <sub>CC</sub>	V	
T <sub>amb</sub>	operating ambient temperature range	-40		+85	-40		+85	°C	see DC and AC CHARACTERISTICS
T <sub>amb</sub>	operating ambient temperature range	-40		+125	-40		+125	°C	
t <sub>r</sub> , t <sub>f</sub>	input rise and fall times (pin 5)		6.0	1000 500 400		6.0	500	ns	V <sub>CC</sub> = 2.0 V V <sub>CC</sub> = 4.5 V V <sub>CC</sub> = 6.0 V

RATINGS

Limiting values in accordance with the Absolute Maximum System (IEC 134)

Voltages are referenced to GND (ground = 0 V)

SYMBOL	PARAMETER	MIN.	MAX.	UNIT	CONDITIONS
V <sub>CC</sub>	DC supply voltage	-0.5	+7	V	
±I <sub>IJK</sub>	DC input diode current		20	mA	for V <sub>I</sub> < -0.5 V or V <sub>I</sub> > V <sub>CC</sub> + 0.5 V
±I <sub>OK</sub>	DC output diode current		20	mA	for V <sub>O</sub> < -0.5 V or V <sub>O</sub> > V <sub>CC</sub> + 0.5 V
±I <sub>O</sub>	DC output source or sink current		25	mA	for -0.5 V < V <sub>O</sub> < V <sub>CC</sub> + 0.5 V
±I <sub>CC</sub> ; ±I <sub>GND</sub>	DC V <sub>CC</sub> or GND current		50	mA	
T <sub>stg</sub>	storage temperature range	-65	+150	°C	
P <sub>tot</sub>	power dissipation per package				for temperature range: -40 to +125 °C
	plastic DIL		750	mW	74HC/HCT above +70 °C: derate linearly with 12 mW/K
	plastic mini-pack (SO)		500	mW	above +70 °C: derate linearly with 8 mW/K

## 查询"74HCT4046AD-T"供应商

## DC CHARACTERISTICS FOR 74HC

## Quiescent supply current

Voltages are referenced to GND (ground = 0 V)

SYMBOL	PARAMETER	T <sub>amb</sub> (°C)						UNIT	TEST CONDITIONS		
		74HC							V <sub>CC</sub> V	OTHER	
		+25			-40 to +85		-40 to +125				
		min.	typ.	max.	min.	max.	min.				max.
I <sub>CC</sub>	quiescent supply current (VCO disabled)			8.0		80.0		160.0	μA	6.0	pins 3, 5, and 14 at V <sub>CC</sub> ; pin 9 at GND; I <sub>I</sub> at pins 3 and 14 to be excluded

## Phase comparator section

Voltages are referenced to GND (ground = 0 V)

SYMBOL	PARAMETER	T <sub>amb</sub> (°C)						UNIT	TEST CONDITIONS			
		74HC							V <sub>CC</sub> V	V <sub>I</sub>	OTHER	
		+25			-40 to +85		-40 to +125					
		min.	typ.	max.	min.	max.	min.					max.
V <sub>IH</sub>	DC coupled HIGH level input voltage SIG <sub>IN</sub> , COMP <sub>IN</sub>	1.5 3.15 4.2	1.2 2.4 3.2		1.5 3.15 4.2		1.5 3.15 4.2		V	2.0 4.5 6.0		
V <sub>IL</sub>	DC coupled LOW level input voltage SIG <sub>IN</sub> , COMP <sub>IN</sub>		0.8 2.1 2.8	0.5 1.35 1.8		0.5 1.35 1.8	0.5 1.35 1.8		V	2.0 4.5 6.0		
V <sub>OH</sub>	HIGH level output voltage PC <sub>OUT</sub> , PC <sub>nOUT</sub>	1.9 4.4 5.9	2.0 4.5 6.0		1.9 4.4 5.9		1.9 4.4 5.9		V	2.0 4.5 6.0	V <sub>IH</sub> or V <sub>IL</sub>	-I <sub>O</sub> = 20 μA -I <sub>O</sub> = 20 μA -I <sub>O</sub> = 20 μA
V <sub>OH</sub>	HIGH level output voltage PC <sub>OUT</sub> , PC <sub>nOUT</sub>	3.98 5.48	4.32 5.81		3.84 5.34		3.7 5.2		V	4.5 6.0	V <sub>IH</sub> or V <sub>IL</sub>	-I <sub>O</sub> = 4.0 mA -I <sub>O</sub> = 5.2 mA
V <sub>OL</sub>	LOW level output voltage PC <sub>OUT</sub> , PC <sub>nOUT</sub>		0 0 0	0.1 0.1 0.1		0.1 0.1 0.1	0.1 0.1 0.1		V	2.0 4.5 6.0	V <sub>IH</sub> or V <sub>IL</sub>	I <sub>O</sub> = 20 μA I <sub>O</sub> = 20 μA I <sub>O</sub> = 20 μA
V <sub>OL</sub>	LOW level output voltage PC <sub>OUT</sub> , PC <sub>nOUT</sub>		0.15 0.16	0.26 0.26		0.33 0.33	0.4 0.4		V	4.5 6.0	V <sub>IH</sub> or V <sub>IL</sub>	I <sub>O</sub> = 4.0 mA I <sub>O</sub> = 5.2 mA
±I <sub>I</sub>	input leakage current SIG <sub>IN</sub> , COMP <sub>IN</sub>			3.0 7.0 18.0 30.0		4.0 9.0 23.0 38.0		5.0 11.0 27.0 45.0	μA	2.0 3.0 4.5 6.0	V <sub>CC</sub> or GND	
±I <sub>OZ</sub>	3-state OFF-state current PC <sub>2OUT</sub>			0.5		5.0		10.0	μA	6.0	V <sub>IH</sub> or V <sub>IL</sub>	V <sub>O</sub> = V <sub>CC</sub> or GND
R <sub>I</sub>	input resistance SIG <sub>IN</sub> , COMP <sub>IN</sub>		800 250 150						kΩ	3.0 4.5 6.0		V <sub>I</sub> at self-bias operating point; ΔV <sub>I</sub> = 0.5 V; see Figs 12, 13 and 14

查询"74HCT4046AD-T"供应商

DC CHARACTERISTICS FOR 74HC (Cont'd)  
VCO section

Voltages are referenced to GND (ground = 0 V)

SYMBOL	PARAMETER	T <sub>amb</sub> (°C)						UNIT	TEST CONDITIONS			
		74HC							V <sub>CC</sub> V	V <sub>I</sub>	OTHER	
		+25			-40 to +85		-40 to +125					
		min.	typ.	max.	min.	max.	min.					max.
V <sub>IH</sub>	HIGH level input voltage INH	2.1 3.15 4.2	1.7 2.4 3.2		2.1 3.15 4.2		2.1 3.15 4.2	V	3.0 4.5 6.0			
V <sub>IL</sub>	LOW level input voltage INH		1.3 2.1 2.8	0.9 1.35 1.8		0.9 1.35 1.8		0.9 1.35 1.8	V	3.0 4.5 6.0		
V <sub>OH</sub>	HIGH level output voltage VCO <sub>OUT</sub>	2.9 4.4 5.9	3.0 4.5 6.0		2.9 4.4 5.9		2.9 4.4 5.9	V	3.0 4.5 6.0	V <sub>IH</sub> or V <sub>IL</sub>	-I <sub>O</sub> = 20 μA -I <sub>O</sub> = 20 μA -I <sub>O</sub> = 20 μA	
V <sub>OH</sub>	HIGH level output voltage VCO <sub>OUT</sub>	3.98 5.48	4.32 5.81		3.84 5.34		3.7 5.2	V	4.5 6.0	V <sub>IH</sub> or V <sub>IL</sub>	-I <sub>O</sub> = 4.0 mA -I <sub>O</sub> = 5.2 mA	
V <sub>OL</sub>	LOW level output voltage VCO <sub>OUT</sub>		0 0 0	0.1 0.1 0.1		0.1 0.1 0.1		0.1 0.1 0.1	V	3.0 4.5 6.0	V <sub>IH</sub> or V <sub>IL</sub>	I <sub>O</sub> = 20 μA I <sub>O</sub> = 20 μA I <sub>O</sub> = 20 μA
V <sub>OL</sub>	LOW level output voltage VCO <sub>OUT</sub>		0.15 0.16	0.26 0.26		0.33 0.33		0.4 0.4	V	4.5 6.0	V <sub>IH</sub> or V <sub>IL</sub>	I <sub>O</sub> = 4.0 mA I <sub>O</sub> = 5.2 mA
V <sub>OL</sub>	LOW level output voltage C1 <sub>A</sub> , C1 <sub>B</sub>			0.40 0.40		0.47 0.47		0.54 0.54	V	4.5 6.0	V <sub>IH</sub> or V <sub>IL</sub>	I <sub>O</sub> = 4.0 mA I <sub>O</sub> = 5.2 mA
±I <sub>I</sub>	input leakage current INH, VCO <sub>IN</sub>			0.1		1.0		1.0	μA	6.0	V <sub>CC</sub> or GND	
R1	resistor range	3.0 3.0 3.0		300 300 300					kΩ	3.0 4.5 6.0		note 1
R2	resistor range	3.0 3.0 3.0		300 300 300					kΩ	3.0 4.5 6.0		note 1
C1	capacitor range	40 40 40		no limit					pF	3.0 4.5 6.0		
V <sub>VCOIN</sub>	operating voltage range at VCO <sub>IN</sub>	1.1 1.1 1.1		1.9 3.4 5.9					V	3.0 4.5 6.0		over the range specified for R1; for linearity see Figs 20 and 21.

Note

1. The parallel value of R1 and R2 should be more than 2.7 kΩ. Optimum performance is achieved when R1 and/or R2 are/is > 10 kΩ.



[查询"74HCT4046AD-T"供应商](#)**Demodulator section**

Voltages are referenced to GND (ground = 0 V)

SYMBOL	PARAMETER	T <sub>amb</sub> (°C)						UNIT	TEST CONDITIONS		
		74HC							V <sub>CC</sub> V	OTHER	
		+25			-40 to +85		-40 to +125				
		min.	typ.	max.	min.	max.	min.				max.
R <sub>S</sub>	resistor range	50 50 50		300 300 300				kΩ	3.0 4.5 6.0	at R <sub>S</sub> > 300 kΩ the leakage current can influence V <sub>DEMOUT</sub>	
V <sub>OFF</sub>	offset voltage V <sub>COIN</sub> to V <sub>DEMOUT</sub>		±30 ±20 ±10					mV	3.0 4.5 6.0	V <sub>I</sub> = V <sub>COIN</sub> = 1/2 V <sub>CC</sub> ; values taken over R <sub>S</sub> range; see Fig. 15	
R <sub>D</sub>	dynamic output resistance at V <sub>DEMOUT</sub>		25 25 25					Ω	3.0 4.5 6.0	V <sub>DEMOUT</sub> = 1/2 V <sub>CC</sub>	

[查询"74HCT4046AD-T"供应商](#)

## AC CHARACTERISTICS FOR 74HC

## Phase comparator section

GND = 0 V;  $t_r = t_f = 6$  ns;  $C_L = 50$  pF

SYMBOL	PARAMETER	$T_{amb}$ (°C)						UNIT	TEST CONDITIONS		
		74HC							$V_{CC}$ V	OTHER	
		+25			-40 to +85		-40 to +125				
		min.	typ.	max.	min.	max.	min.		max.		
$t_{PHL}/$ $t_{PLH}$	propagation delay SIG <sub>IN</sub> , COMP <sub>IN</sub> to PC <sub>1OUT</sub>		63 23 18	200 40 34		250 50 43		300 60 51	ns	2.0 4.5 6.0	Fig. 16
$t_{PHL}/$ $t_{PLH}$	propagation delay SIG <sub>IN</sub> , COMP <sub>IN</sub> to PC <sub>2OUT</sub>		96 35 28	340 68 58		425 85 72		510 102 87	ns	2.0 4.5 6.0	Fig. 16
$t_{PHL}/$ $t_{PLH}$	propagation delay SIG <sub>IN</sub> , COMP <sub>IN</sub> to PC <sub>3OUT</sub>		77 28 22	270 54 46		340 68 58		405 81 69	ns	2.0 4.5 6.0	Fig. 16
$t_{pZH}/$ $t_{pZL}$	3-state output enable time SIG <sub>IN</sub> , COMP <sub>IN</sub> to PC <sub>2OUT</sub>		83 30 24	280 56 48		350 70 60		420 84 71	ns	2.0 4.5 6.0	Fig. 17
$t_{pHZ}/$ $t_{pLZ}$	3-state output disable time SIG <sub>IN</sub> , COMP <sub>IN</sub> to PC <sub>2OUT</sub>		99 36 29	325 65 55		405 81 69		490 98 83	ns	2.0 4.5 6.0	Fig. 17
$t_{THL}/$ $t_{TLH}$	output transition time		19 7 6	75 15 13		95 19 16		110 22 19	ns	2.0 4.5 6.0	Fig. 16
$V_I$ (p-p)	AC coupled input sensitivity (peak-to-peak value) at SIG <sub>IN</sub> or COMP <sub>IN</sub>		9 11 15 33						mV	2.0 3.0 4.5 6.0	$f_i = 1$ MHz

## VCO section

GND = 0 V;  $t_r = t_f = 6$  ns;  $C_L = 50$  pF

SYMBOL	PARAMETER	$T_{amb}$ (°C)						UNIT	TEST CONDITIONS		
		74HC							$V_{CC}$ V	OTHER	
		+25			-40 to +85		-40 to +125				
		min.	typ.	max.	typ.	max.	min.		max.		
$\Delta f/T$	frequency stability with temperature change				0.20 0.15 0.14				%/K	3.0 4.5 6.0	$V_I = V_{VCOIN} = 1/2 V_{CC}$ ; $R_1 = 100$ k $\Omega$ ; $R_2 = \infty$ ; $C_1 = 100$ pF; see Fig. 18
$f_o$	VCO centre frequency (duty factor = 50%)	3.0 11.0 13.0	10.0 17.0 21.0						MHz	3.0 4.5 6.0	$V_{VCOIN} = 1/2 V_{CC}$ ; $R_1 = 3$ k $\Omega$ ; $R_2 = \infty$ ; $C_1 = 40$ pF; see Fig. 19
$\Delta f_{VCO}$	VCO frequency linearity		1.0 0.4 0.3						%	3.0 4.5 6.0	$R_1 = 100$ k $\Omega$ ; $R_2 = \infty$ ; $C_1 = 100$ pF; see Figs 20 and 21
$\delta_{VCO}$	duty factor at VCO <sub>OUT</sub>		50 50 50						%	3.0 4.5 6.0	

[查询"74HCT4046AD-T"供应商](#)
**DC CHARACTERISTICS FOR 74HCT****Quiescent supply current**

Voltages are referenced to GND (ground = 0 V)

SYMBOL	PARAMETER	T <sub>amb</sub> (°C)						UNIT	TEST CONDITIONS		
		74HCT							V <sub>CC</sub> V	OTHER	
		+25			-40 to +85		-40 to +125				
		min.	typ.	max.	min.	max.	min.				max.
I <sub>CC</sub>	quiescent supply current (VCO disabled)			8.0		80.0		160.0	μA	6.0	pins 3, 5 and 14 at V <sub>CC</sub> ; pin 9 at GND; I <sub>I</sub> at pins 3 and 14 to be excluded
ΔI <sub>CC</sub>	additional quiescent supply current per input pin for unit load coefficient is 1 (note 1) V <sub>I</sub> = V <sub>CC</sub> - 2.1 V		100	360		450		490	μA	4.5 to 5.5	pins 3 and 14 at V <sub>CC</sub> ; pin 9 at GND; I <sub>I</sub> at pins 3 and 14 to be excluded

**Note**

1. The value of additional quiescent supply current (ΔI<sub>CC</sub>) for a unit load of 1 is given above.  
To determine ΔI<sub>CC</sub> per input, multiply this value by the unit load coefficient shown in the table below.

INPUT	UNIT LOAD COEFFICIENT
INH	1.00

[查询"74HCT4046AD-T"供应商](#)

DC CHARACTERISTICS FOR 74HCT

Phase comparator section

Voltages are referenced to GND (ground = 0 V)

SYMBOL	PARAMETER	T <sub>amb</sub> (°C)						UNIT	TEST CONDITIONS			
		74HCT							V <sub>CC</sub> V	V <sub>I</sub>	OTHER	
		+25			-40 to +85		-40 to +125					
		min.	typ.	max.	min.	max.	min.					max.
V <sub>IH</sub>	DC coupled HIGH level input voltage SIG <sub>1IN</sub> , COMP <sub>1IN</sub>	3.15	2.4					V	4.5			
V <sub>IL</sub>	DC coupled LOW level input voltage SIG <sub>1IN</sub> , COMP <sub>1IN</sub>		2.1	1.35				V	4.5			
V <sub>OH</sub>	HIGH level output voltage PC <sub>POUT</sub> , PC <sub>nOUT</sub>	4.4	4.5		4.4		4.4	V	4.5	V <sub>IH</sub> or V <sub>IL</sub>	-I <sub>O</sub> = 20 μA	
V <sub>OH</sub>	HIGH level output voltage PC <sub>POUT</sub> , PC <sub>nOUT</sub>	3.98	4.32		3.84		3.7	V	4.5	V <sub>IH</sub> or V <sub>IL</sub>	-I <sub>O</sub> = 4.0 mA	
V <sub>OL</sub>	LOW level output voltage PC <sub>POUT</sub> , PC <sub>nOUT</sub>		0	0.1		0.1		0.1	V	4.5	V <sub>IH</sub> or V <sub>IL</sub>	I <sub>O</sub> = 20 μA
V <sub>OL</sub>	LOW level output voltage PC <sub>POUT</sub> , PC <sub>nOUT</sub>		0.15	0.26		0.33		0.4	V	4.5	V <sub>IH</sub> or V <sub>IL</sub>	I <sub>O</sub> = 4.0 mA
±I <sub>I</sub>	input leakage current SIG <sub>1IN</sub> , COMP <sub>1IN</sub>			30		38		45	μA	5.5	V <sub>CC</sub> or GND	
±I <sub>OZ</sub>	3-state OFF-state current PC <sub>2OUT</sub>			0.5		5.0		10.0	μA	5.5	V <sub>IH</sub> or V <sub>IL</sub>	V <sub>O</sub> = V <sub>CC</sub> or GND
R <sub>I</sub>	input resistance SIG <sub>1IN</sub> , COMP <sub>1IN</sub>		250						kΩ	4.5		V <sub>I</sub> at self-bias operating point; ΔV <sub>I</sub> = 0.5 V; see Figs 12, 13 and 14

## 查询"74HCT4046AD-T"供应商

## DC CHARACTERISTICS FOR 74HCT

## VCO section

Voltages are referenced to GND (ground = 0 V)

SYMBOL	PARAMETER	T <sub>amb</sub> (°C)								UNIT	TEST CONDITIONS		
		74HCT									V <sub>CC</sub> V	V <sub>I</sub>	OTHER
		+25			-40 to +85		-40 to +125						
		min.	typ.	max.	min.	max.	min.	max.					
V <sub>IH</sub>	HIGH level input voltage INH	2.0	1.6		2.0		2.0		V	4.5 to 5.5			
V <sub>IL</sub>	LOW level input voltage INH		1.2	0.8		0.8		0.8	V	4.5 to 5.5			
V <sub>OH</sub>	HIGH level output voltage VCO <sub>OUT</sub>	4.4	4.5		4.4		4.4		V	4.5	V <sub>IH</sub> or V <sub>IL</sub>	-I <sub>O</sub> = 20 μA	
V <sub>OH</sub>	HIGH level output voltage VCO <sub>OUT</sub>	3.98	4.32		3.84		3.7		V	4.5	V <sub>IH</sub> or V <sub>IL</sub>	-I <sub>O</sub> = 4.0 mA	
V <sub>OL</sub>	LOW level output voltage VCO <sub>OUT</sub>		0	0.1		0.1		0.1	V	4.5	V <sub>IH</sub> or V <sub>IL</sub>	I <sub>O</sub> = 20 μA	
V <sub>OL</sub>	LOW level output voltage VCO <sub>OUT</sub>		0.15	0.26		0.33		0.4	V	4.5	V <sub>IH</sub> or V <sub>IL</sub>	I <sub>O</sub> = 4.0 mA	
V <sub>OL</sub>	LOW level output voltage C1 <sub>A</sub> , C1 <sub>B</sub> (test purposes only)			0.40		0.47		0.54	V	4.5	V <sub>IH</sub> or V <sub>IL</sub>	I <sub>O</sub> = 4.0 mA	
±I <sub>I</sub>	input leakage current INH, VCO <sub>IN</sub>			0.1		1.0		1.0	μA	5.5	V <sub>CC</sub> or GND		
R1	resistor range	3.0		300					kΩ	4.5		note 1	
R2	resistor range	3.0		300					kΩ	4.5		note 1	
C1	capacitor range	40		no limit					pF	4.5			
V <sub>VCOIN</sub>	operating voltage range at VCO <sub>IN</sub>	1.1		3.4					V	4.5		over the range specified for R1; for linearity see Figs 20 and 21.	

## Note

1. The parallel value of R1 and R2 should be more than 2.7 kΩ. Optimum performance is achieved when R1 and/or R2 are/is &gt; 10 kΩ.

[查询"74HCT4046AD-T"供应商](#)

DC CHARACTERISTICS FOR 74HCT

Demodulator section

Voltages are referenced to GND (ground = 0 V)

SYMBOL	PARAMETER	T <sub>amb</sub> (°C)								UNIT	TEST CONDITIONS	
		74HCT									V <sub>CC</sub> V	OTHER
		+25			-40 to +85		-40 to +125					
		min.	typ.	max.	min.	max.	min.	max.				
R <sub>S</sub>	resistor range	50		300						kΩ	4.5	at R <sub>S</sub> > 300 kΩ the leakage current can influence V <sub>DEMOUT</sub>
V <sub>OFF</sub>	offset voltage V <sub>COIN</sub> to V <sub>DEMOUT</sub>		±20							mV	4.5	V <sub>I</sub> = V <sub>VCOIN</sub> = 1/2 V <sub>CC</sub> ; values taken over R <sub>S</sub> range; see Fig. 15
R <sub>D</sub>	dynamic output resistance at DEMOUT		25							Ω	4.5	V <sub>DEMOUT</sub> = 1/2 V <sub>CC</sub>

## 查询"74HCT4046AD-T"供应商

## AC CHARACTERISTICS FOR 74HCT

## Phase comparator section

GND = 0 V;  $t_r = t_f = 6$  ns;  $C_L = 50$  pF

SYMBOL	PARAMETER	T <sub>amb</sub> (°C)						UNIT	TEST CONDITIONS		
		74HCT							V <sub>CC</sub> V	OTHER	
		+25			-40 to +85		-40 to +125				
		min.	typ.	max.	min.	max.	min.				max.
t <sub>PHL</sub> / t <sub>PLH</sub>	propagation delay SIG <sub>1IN</sub> , COMP <sub>1IN</sub> to PC <sub>1OUT</sub>		23	40		50		60	ns	4.5	Fig. 16
t <sub>PHL</sub> / t <sub>PLH</sub>	propagation delay SIG <sub>1IN</sub> , COMP <sub>1IN</sub> to PC <sub>2OUT</sub>		35	68		85		102	ns	4.5	Fig. 16
t <sub>PHL</sub> / t <sub>PLH</sub>	propagation delay SIG <sub>1IN</sub> , COMP <sub>1IN</sub> to PC <sub>3OUT</sub>		28	54		68		81	ns	4.5	Fig. 16
t <sub>PZH</sub> / t <sub>PZL</sub>	3-state output enable time SIG <sub>1IN</sub> , COMP <sub>1IN</sub> to PC <sub>2OUT</sub>		30	56		70		84	ns	4.5	Fig. 17
t <sub>PHZ</sub> / t <sub>PLZ</sub>	3-state output disable time SIG <sub>1IN</sub> , COMP <sub>1IN</sub> to PC <sub>2OUT</sub>		36	65		81		98	ns	4.5	Fig. 17
t <sub>THL</sub> / t <sub>TLH</sub>	output transition time		7	15		19		22	ns	4.5	Fig. 16
V <sub>I</sub> (p-p)	AC coupled input sensitivity (peak-to-peak value) at SIG <sub>1IN</sub> or COMP <sub>1IN</sub>		15						mV	4.5	f <sub>i</sub> = 1 MHz

## VCO section

GND = 0 V;  $t_r = t_f = 6$  ns;  $C_L = 50$  pF

SYMBOL	PARAMETER	T <sub>amb</sub> (°C)						UNIT	TEST CONDITIONS		
		74HCT							V <sub>CC</sub> V	OTHER	
		+25			-40 to +85		-40 to +125				
		min.	typ.	max.	typ.	max.	min.				max.
Δf/T	frequency stability with temperature change				0.15				%/K	4.5	V <sub>I</sub> = V <sub>VCO1IN</sub> within recommended range; R1 = 100 kΩ; R2 = ∞; C1 = 100 pF; see Fig. 18b
f <sub>o</sub>	VCO centre frequency (duty factor = 50%)	11.0	17.0						MHz	4.5	V <sub>VCO1IN</sub> = 1/2 V <sub>CC</sub> ; R1 = 3 kΩ; R2 = ∞; C1 = 40 pF; see Fig. 19
Δf <sub>VCO</sub>	VCO frequency linearity		0.4						%	4.5	R1 = 100 kΩ; R2 = ∞; C1 = 100 pF; see Figs 20 and 21
δ <sub>VCO</sub>	duty factor at VCO <sub>OUT</sub>		50						%	4.5	

查询"74HCT4046AD-T"供应商

FIGURE REFERENCES FOR DC CHARACTERISTICS

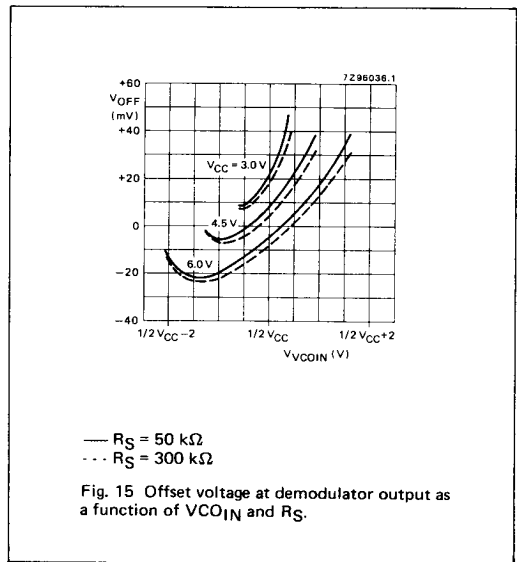
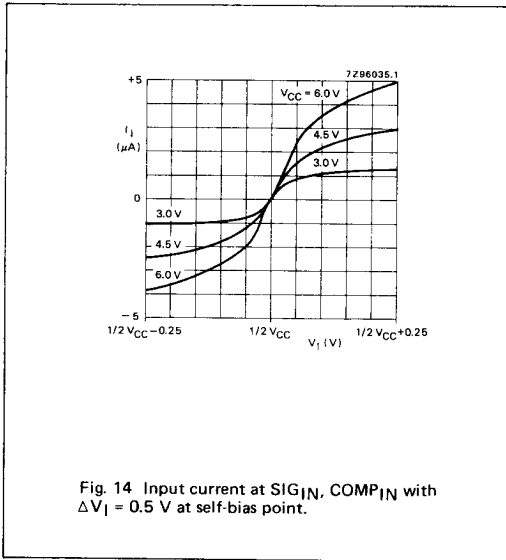
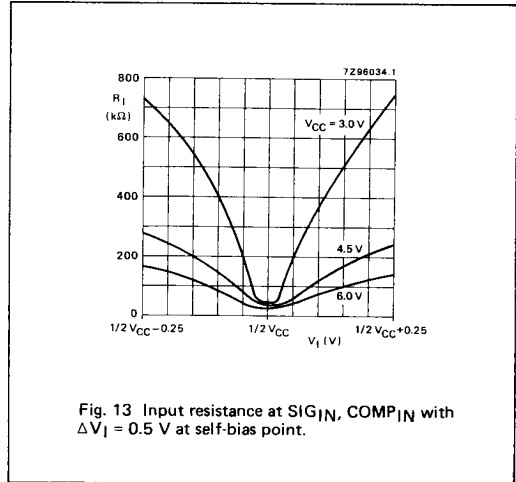
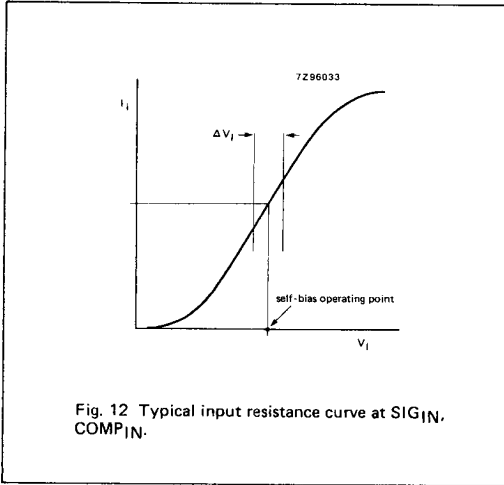



查询"74HCT4046AD-T"供应商

AC WAVEFORMS

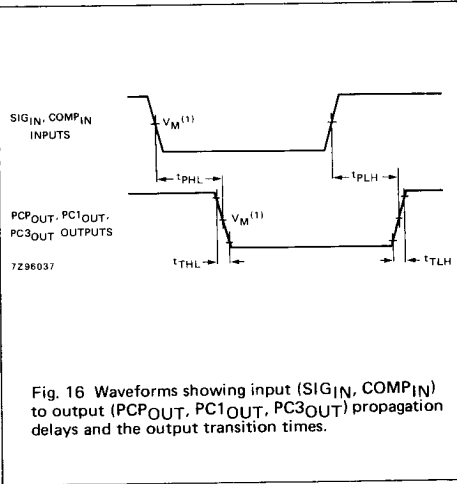

Fig. 16 Waveforms showing input (SIG<sub>IN</sub>, COMP<sub>IN</sub>) to output (PC<sub>2</sub>OUT, PC<sub>1</sub>OUT, PC<sub>3</sub>OUT) propagation delays and the output transition times.

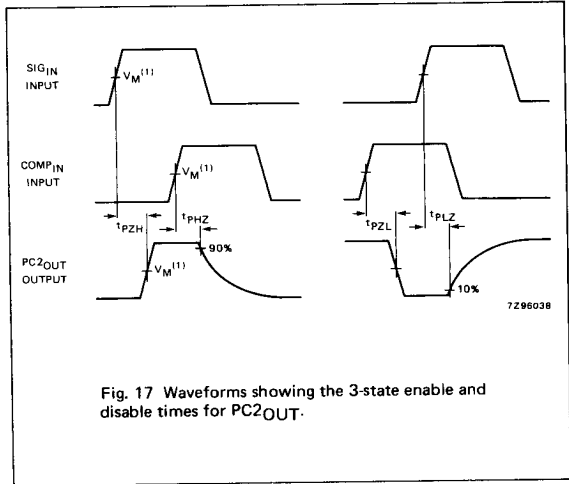

Fig. 17 Waveforms showing the 3-state enable and disable times for PC<sub>2</sub>OUT.

Note to AC waveforms

(1) HC :  $V_M = 50\%$ ;  $V_I = \text{GND to } V_{CC}$ .

查询"74HCT4046AD-T"供应商

AC WAVEFORMS (Continued)

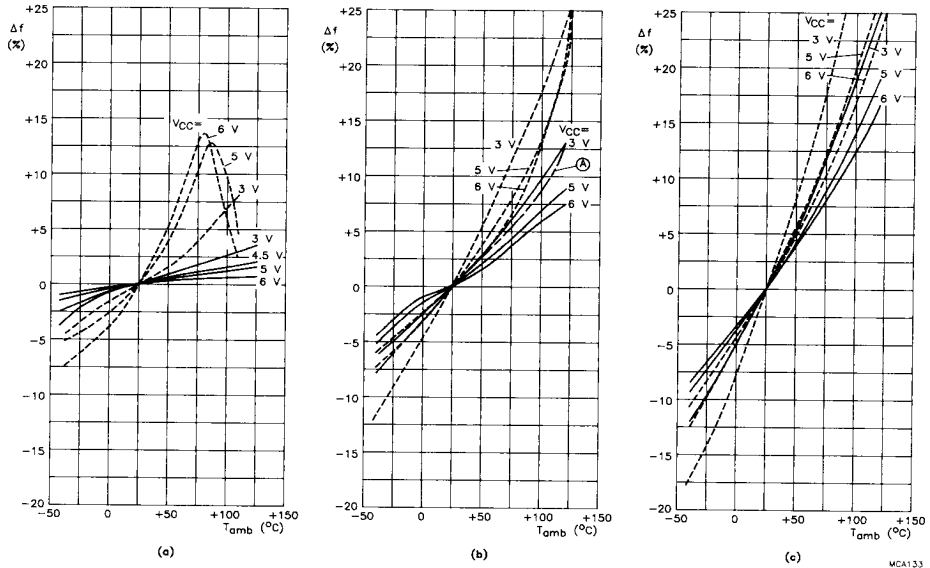

Fig.18 Frequency stability of the VCO as a function of ambient temperature with supply voltage as a parameter.  
 — without offset ( $R_2 = \infty$ ): (a)  $R_1 = 3\text{ k}\Omega$ ; (b)  $R_1 = 10\text{ k}\Omega$ ; (c)  $R_1 = 300\text{ k}\Omega$ .  
 - - - with offset ( $R_1 = \infty$ ): (a)  $R_2 = 3\text{ k}\Omega$ ; (b)  $R_2 = 10\text{ k}\Omega$ ; (c)  $R_2 = 300\text{ k}\Omega$ .  
 In (b), the frequency stability for  $R_1 = R_2 = 10\text{ k}\Omega$  at 5 V is also given (curve A). This curve is set by the total VCO bias current, and is not simply the addition of the two  $10\text{ k}\Omega$  stability curves.  $C_1 = 100\text{ pF}$ ;  $V_{VCO\text{ IN}} = 0.5 V_{CC}$ .

[查询"74HCT4046AD-T"供应商](#)

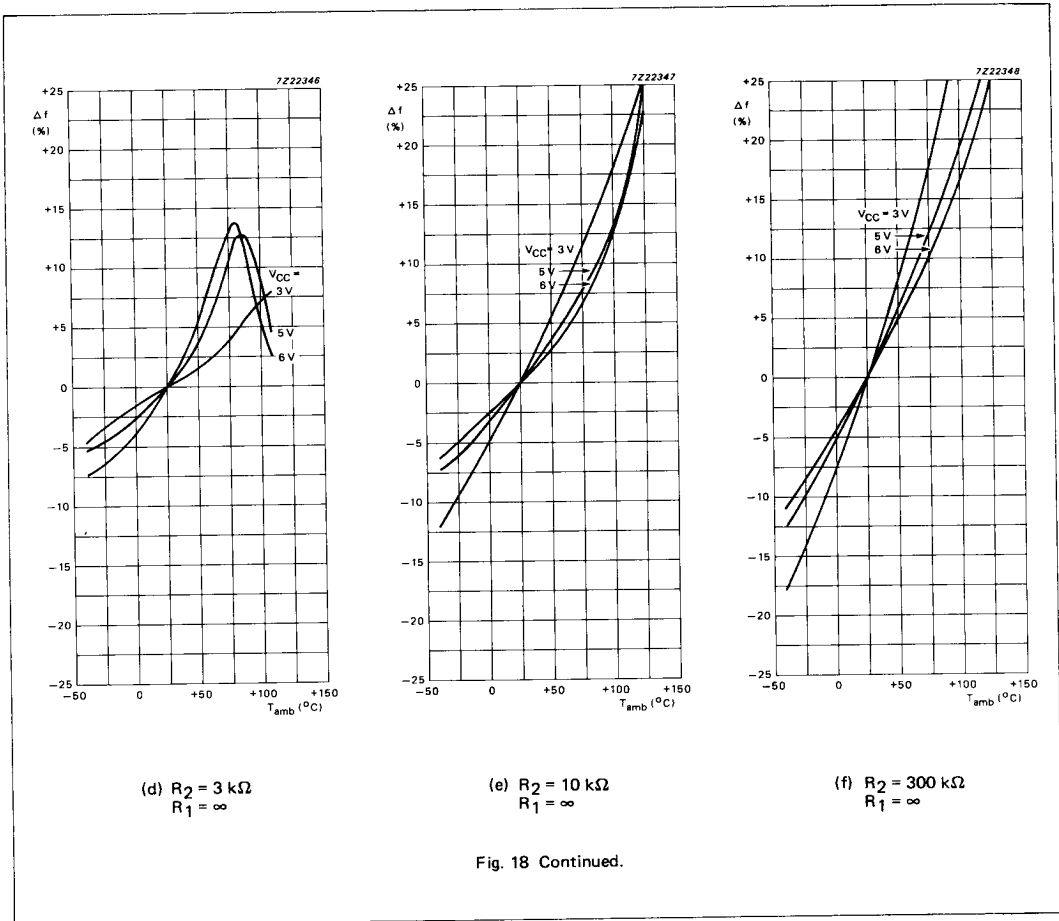

Fig. 18 Continued.

**Note to Fig. 18**

To obtain optimum temperature stability, C1 must be as small as possible but larger than 100 pF.

AC WAVEFORMS (Continued)  
普通 74HC/HCT4046A-T"供应商

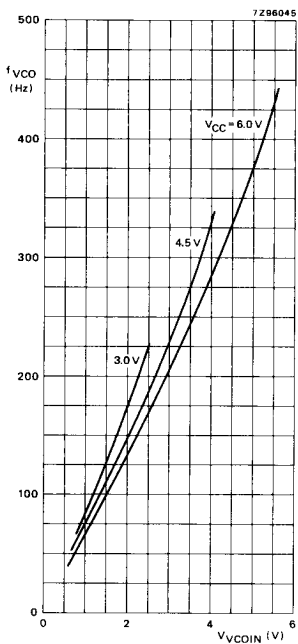
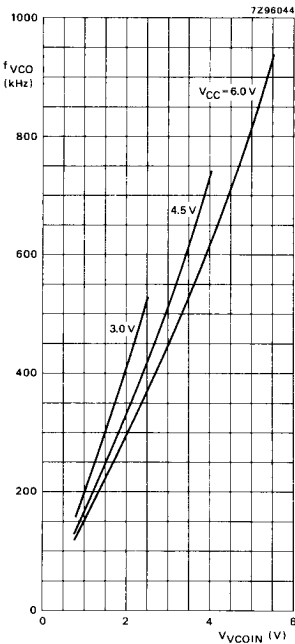
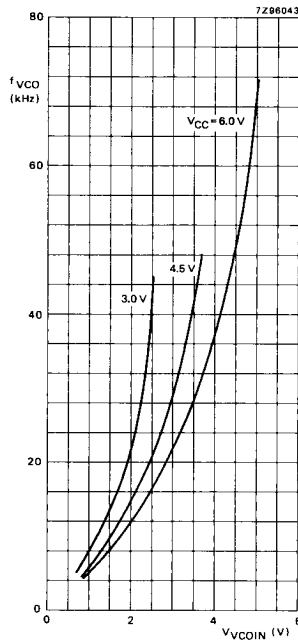
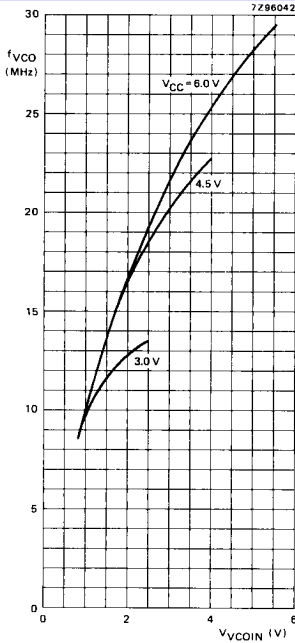
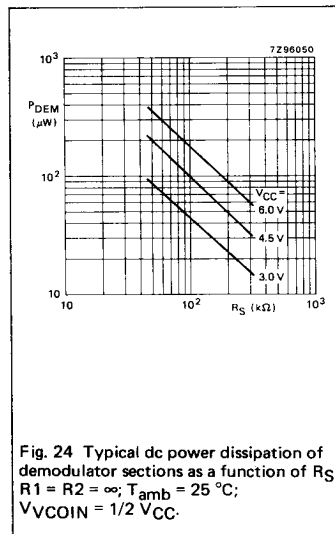
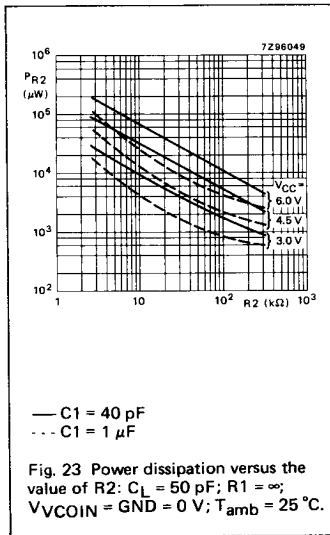
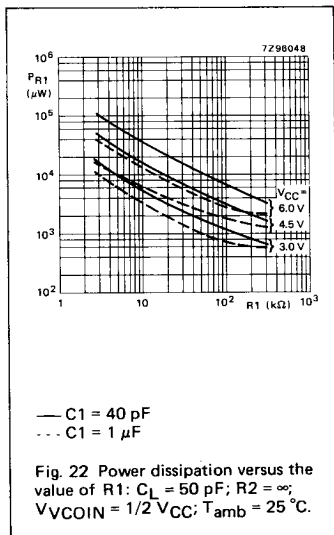
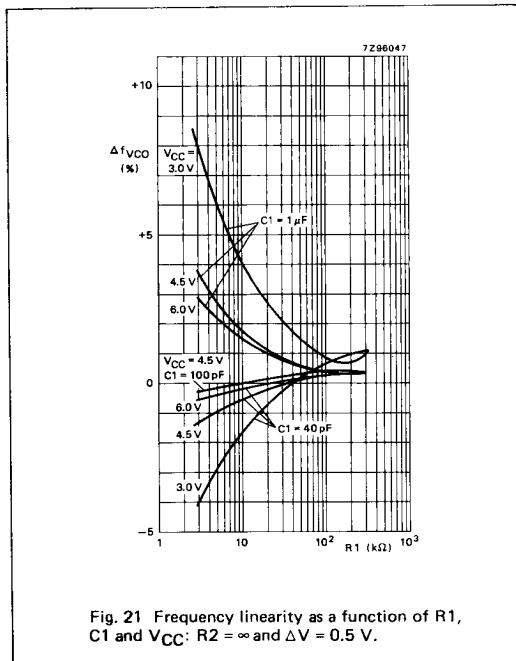
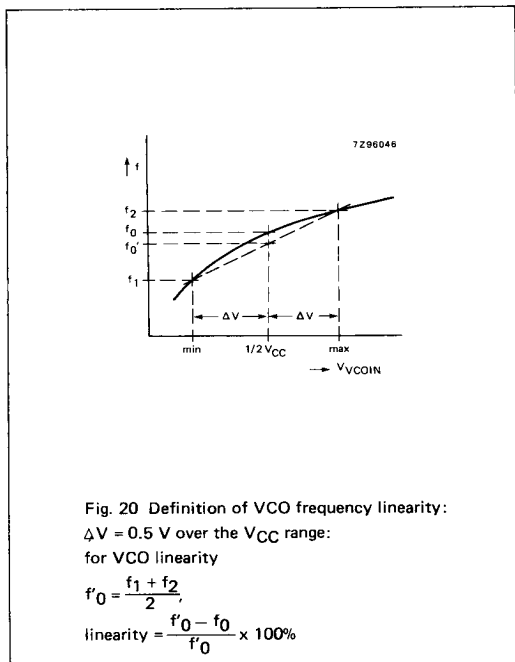

Fig. 19 Graphs showing VCO frequency ( $f_{VCO}$ ) as a function of the VCO input voltage ( $V_{VCOIN}$ ).

查询"74HCT4046AD-T"供应商



查询"74HCT4046AD-T"供应商

APPLICATION INFORMATION

This information is a guide for the approximation of values of external components to be used with the 74HC/HCT4046A in a phase-lock-loop system.

References should be made to Figs 29, 30 and 31 as indicated in the table.

Values of the selected components should be within the following ranges:

- R1 between 3 kΩ and 300 kΩ;
- R2 between 3 kΩ and 300 kΩ;
- R1 + R2 parallel value > 2.7 kΩ;
- C1 greater than 40 pF.

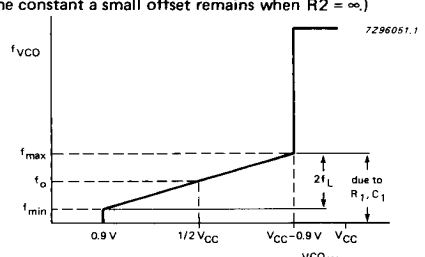
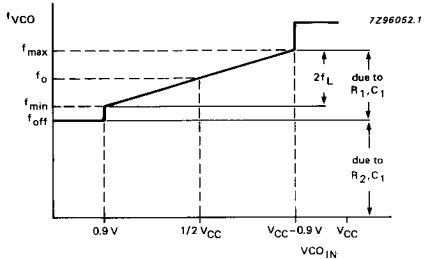
SUBJECT	PHASE COMPARATOR	DESIGN CONSIDERATIONS
VCO frequency without extra offset	PC1, PC2 or PC3	<p><b>VCO frequency characteristic</b></p> <p>With <math>R2 = \infty</math> and <math>R1</math> within the range <math>3\text{ k}\Omega &lt; R1 &lt; 300\text{ k}\Omega</math>, the characteristics of the VCO operation will be as shown in Fig. 25. (Due to <math>R1</math>, <math>C1</math> time constant a small offset remains when <math>R2 = \infty</math>.)</p>  <p>Fig. 25 Frequency characteristic of VCO operating without offset: <math>f_o</math> = centre frequency; <math>2f_L</math> = frequency lock range.</p>
	PC1	<p><b>Selection of R1 and C1</b></p> <p>Given <math>f_o</math>, determine the values of <math>R1</math> and <math>C1</math> using Fig. 29.</p>
	PC2 or PC3	<p>Given <math>f_{max}</math> and <math>f_o</math>, determine the values of <math>R1</math> and <math>C1</math> using Fig. 29, use Fig. 31 to obtain <math>2f_L</math> and then use this to calculate <math>f_{min}</math>.</p>
VCO frequency with extra offset	PC1, PC2 or PC3	<p><b>VCO frequency characteristic</b></p> <p>With <math>R1</math> and <math>R2</math> within the ranges <math>3\text{ k}\Omega &lt; R1 &lt; 300\text{ k}\Omega</math>, <math>3\text{ k}\Omega &lt; R2 &lt; 300\text{ k}\Omega</math>, the characteristics of the VCO operation will be as shown in Fig. 26.</p>  <p>Fig. 26 Frequency characteristic of VCO operating with offset: <math>f_o</math> = centre frequency; <math>2f_L</math> = frequency lock range.</p>
	PC1, PC2 or PC3	<p><b>Selection of R1, R2 and C1</b></p> <p>Given <math>f_o</math> and <math>f_L</math>, determine the value of product <math>R1C1</math> by using Fig. 31. Calculate <math>f_{off}</math> from the equation <math>f_{off} = f_o - 1.6f_L</math>. Obtain the values of <math>C1</math> and <math>R2</math> by using Fig. 30. Calculate the value of <math>R1</math> from the value of <math>C1</math> and the product <math>R1C1</math>.</p>

查询"74HCT4046AD-T"供应商

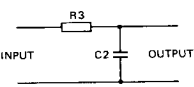
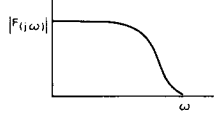
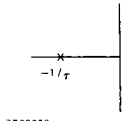
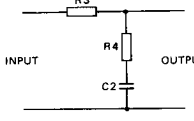
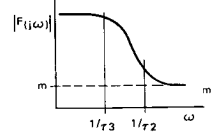
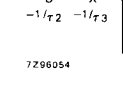
SUBJECT	PHASE COMPARATOR	DESIGN CONSIDERATIONS
PLL conditions with no signal at the SIG <sub>IN</sub> input	PC1	VCO adjusts to $f_o$ with $\phi_{\text{DEMOUT}} = 90^\circ$ and $V_{\text{VCOIN}} = 1/2 V_{\text{CC}}$ (see Fig. 6).
	PC2	VCO adjusts to $f_o$ with $\phi_{\text{DEMOUT}} = -360^\circ$ and $V_{\text{VCOIN}} = \text{min.}$ (see Fig. 8).
	PC3	VCO adjusts to $f_o$ with $\phi_{\text{DEMOUT}} = -360^\circ$ and $V_{\text{VCOIN}} = \text{min.}$ (see Fig. 10).
PLL frequency capture range	PC1, PC2 or PC3	<p><b>Loop filter component selection</b></p>  <p>(a) <math>\tau = R3 \times C2</math>      (b) amplitude characteristic      (c) pole-zero diagram</p>   <p>A small capture range (<math>2f_c</math>) is obtained if <math>2f_c \approx 1/\pi (\sqrt{2\pi f_L \tau})</math></p> <p>Fig. 27 Simple loop filter for PLL without offset; <math>R3 \geq 500 \Omega</math>.</p>  <p>(a) <math>\tau_1 = R3 \times C2</math>;      (b) amplitude characteristic      (c) pole-zero diagram  <math>\tau_2 = R4 \times C2</math>;  <math>\tau_3 = (R3 + R4) \times C2</math></p>   <p>Fig. 28 Simple loop filter for PLL with offset; <math>R3 + R4 \geq 500 \Omega</math>.</p>
PLL locks on harmonics at centre frequency	PC1 or PC3	yes
	PC2	no
noise rejection at signal input	PC1	high
	PC2 or PC3	low
AC ripple content when PLL is locked	PC1	$f_r = 2f_i$ , large ripple content at $\phi_{\text{DEMOUT}} = 90^\circ$
	PC2	$f_r = f_i$ , small ripple content at $\phi_{\text{DEMOUT}} = 0^\circ$
	PC3	$f_r = f_i$ , large ripple content at $\phi_{\text{DEMOUT}} = 180^\circ$

查询"74HCT4046AD-T"供应商

APPLICATION INFORMATION (Continued)

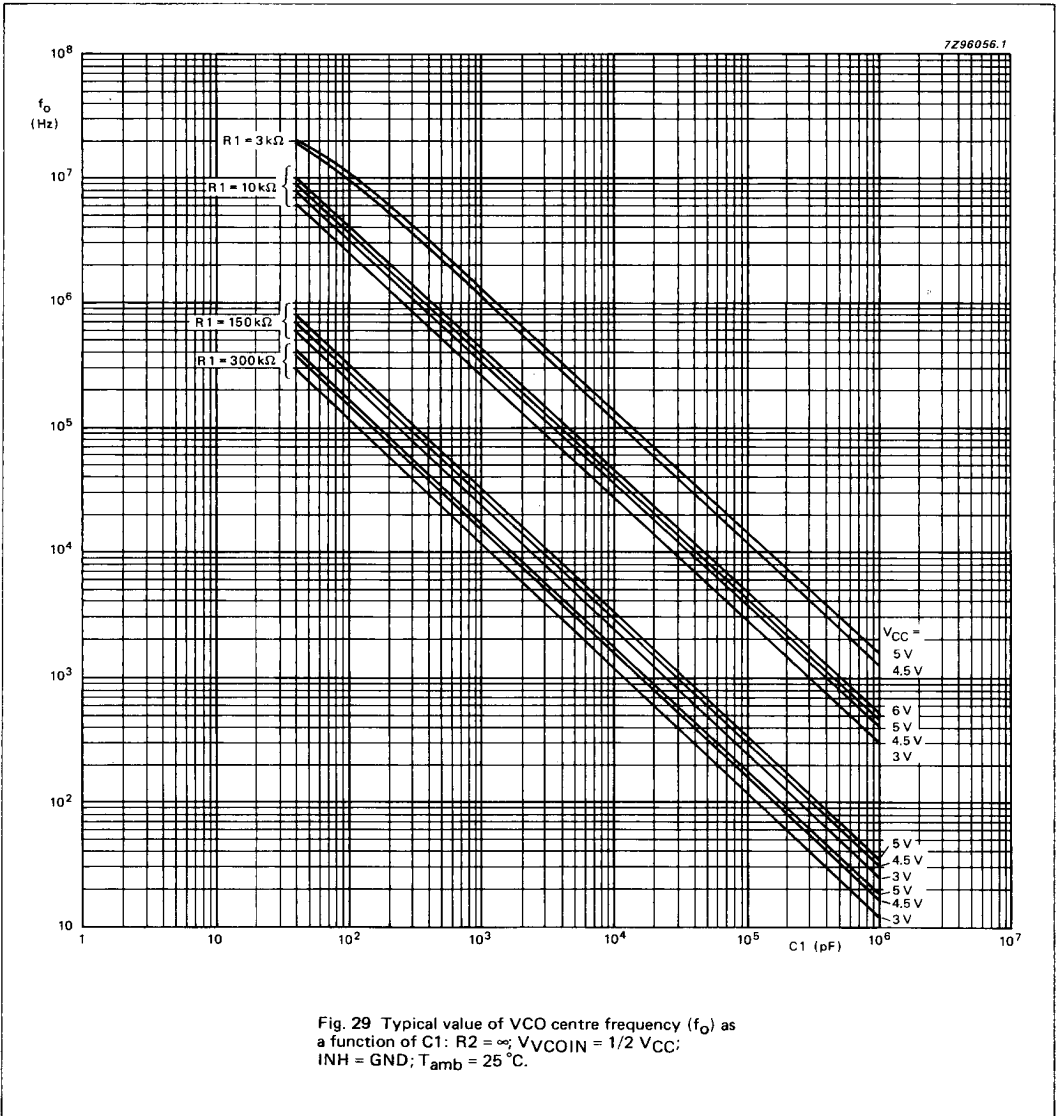

Notes to Fig. 29

1. To obtain optimum VCO performance,  $C_1$  must be as small as possible but larger than 100 pF.
2. Interpolation for various values of  $R_1$  can be easily calculated because, a constant  $R_1C_1$  product will produce almost the same VCO output frequency.

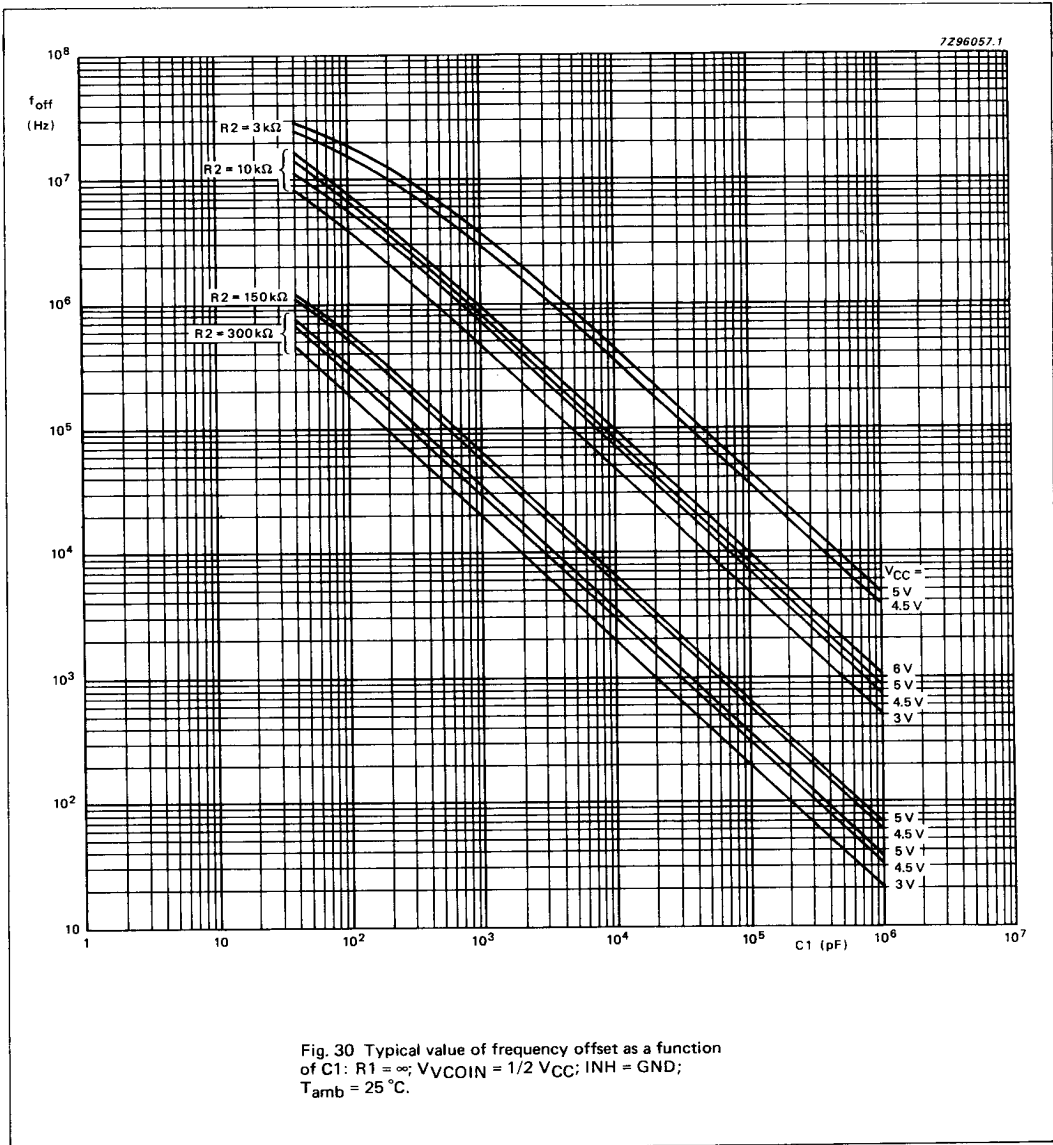

[查询"74HCT4046AD-T"供应商](#)**Notes to Fig. 30**

1. To obtain optimum VCO performance, C1 must be as small as possible but larger than 100 pF.
2. Interpolation for various values of R2 can be easily calculated because, a constant  $R2C1$  product will produce almost the same VCO output frequency.

[查询"74HCT4046AD-T"供应商](#)

APPLICATION INFORMATION (Continued)

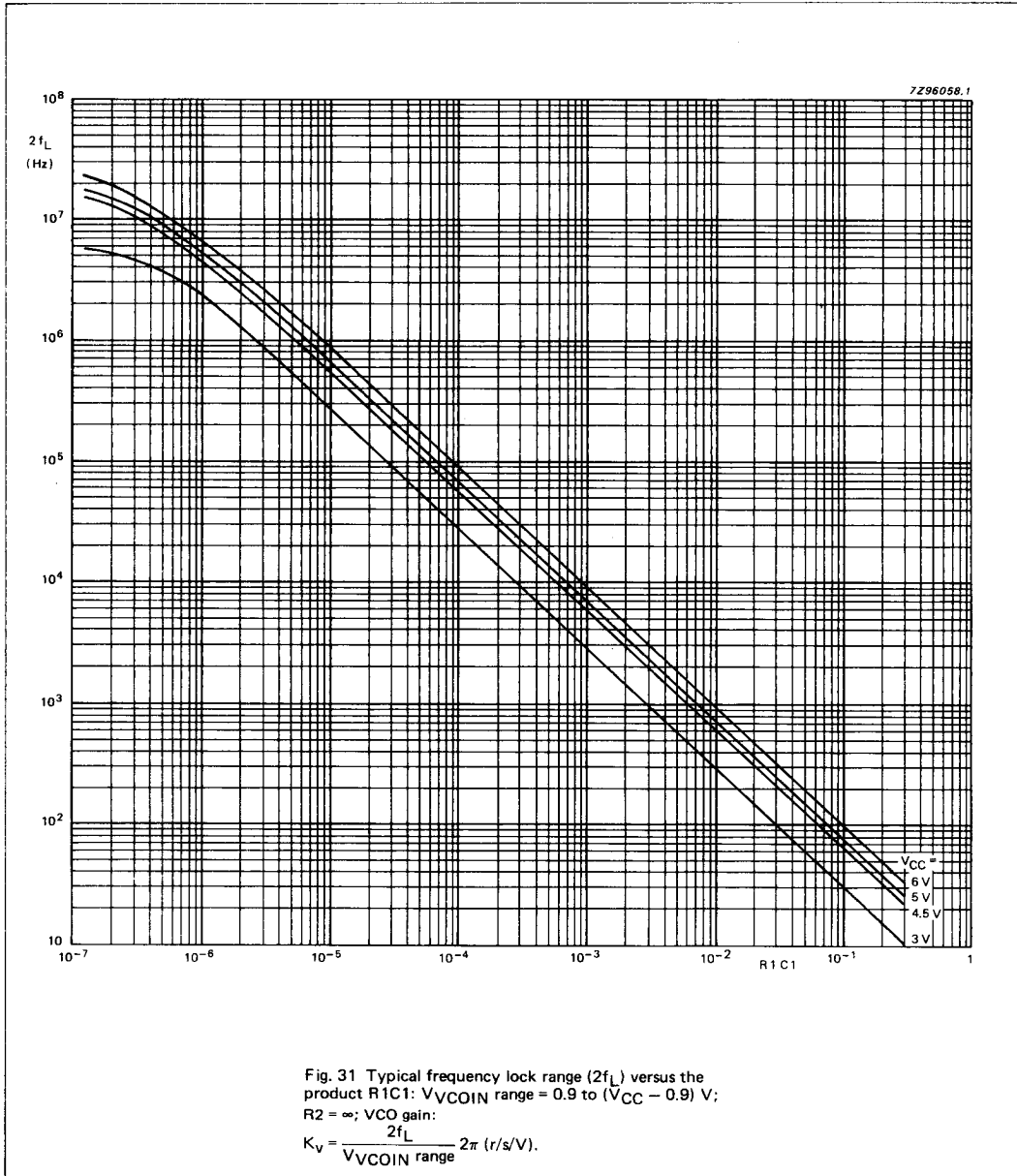

## 查询"74HCT4046AD-T"供应商

## PLL design example

The frequency synthesizer, used in the design example shown in Fig. 32, has the following parameters:

Output frequency: 2 MHz to 3 MHz  
frequency steps : 100 kHz  
settling time : 1 ms  
overshoot : < 20%

The open-loop gain is  $H(s) \times G(s) = K_p \times K_f \times K_o \times K_n$ .

Where:

$K_p$  = phase comparator gain  
 $K_f$  = low-pass filter transfer gain  
 $K_o$  =  $K_v/s$  VCO gain  
 $K_n$  =  $1/n$  divider ratio

The programmable counter ratio  $K_n$  can be found as follows:

$$N_{\min.} = \frac{f_{\text{out}}}{f_{\text{step}}} = \frac{2 \text{ MHz}}{100 \text{ kHz}} = 20$$

$$N_{\max.} = \frac{f_{\text{out}}}{f_{\text{step}}} = \frac{3 \text{ MHz}}{100 \text{ kHz}} = 30$$

The VCO is set by the values of R1, R2 and C1, R2 = 10 k $\Omega$  (adjustable).

The values can be determined using the information in the section "DESIGN CONSIDERATIONS".

With  $f_o = 2.5$  MHz and  $f_L = 500$  kHz this gives the following values ( $V_{CC} = 5.0$  V):

R1 = 10 k $\Omega$   
R2 = 10 k $\Omega$   
C1 = 500 pF

The VCO gain is:

$$K_v = \frac{2f_L \times 2 \times \pi}{0.9 - (V_{CC} - 0.9)} = \frac{1 \text{ MHz}}{3.2} \times 2\pi \approx 2 \times 10^6 \text{ r/s/V}$$

The gain of the phase comparator is:

$$K_p = \frac{V_{CC}}{4 \times \pi} = 0.4 \text{ V/r.}$$

The transfer gain of the filter is given by:

$$K_f = \frac{1 + \tau_2 s}{1 + (\tau_1 + \tau_2) s}$$

Where:

$$\tau_1 = R3C2 \text{ and } \tau_2 = R4C2.$$

The characteristics equation is:

$$1 + H(s) \times G(s) = 0.$$

This results in:

$$s^2 + \frac{1 + K_p \times K_v \times K_n \times \tau_2}{(\tau_1 + \tau_2)} s + \frac{K_p \times K_v \times K_n}{(\tau_1 + \tau_2)} = 0.$$

$$K_p \times K_v \times K_n = 0.$$

The natural frequency  $\omega_n$  is defined as follows:

$$\omega_n = \sqrt{\frac{K_p \times K_v \times K_n}{(\tau_1 + \tau_2)}}.$$

and the damping value  $\xi$  is defined as follows:

$$\xi = \frac{1}{2\omega_n} \times \frac{1 + K_p \times K_v \times K_n \times \tau_2}{(\tau_1 + \tau_2)}.$$

In Fig. 33 the output frequency response to a step of input frequency is shown.

The overshoot and settling time percentages are now used to determine  $\omega_n$ . From Fig. 33 it can be seen that the damping ratio  $\xi = 0.45$  will produce an overshoot of less than 20% and settle to within 5% at  $\omega_n t = 5$ . The required settling time is 1 ms. This results in:

$$\omega_n = \frac{5}{t} = \frac{5}{0.001} = 5 \times 10^3 \text{ r/s.}$$

Rewriting the equation for natural frequency results in:

$$(\tau_1 + \tau_2) = \frac{K_p \times K_v \times K_n}{\omega_n^2}.$$

The maximum overshoot occurs at  $N_{\max.}$ :

$$(\tau_1 + \tau_2) = \frac{0.4 \times 2 \times 10^6}{5000^2 \times 30} = 0.0011 \text{ s.}$$

When  $C2 = 470$  nF, then

$$R4 = \frac{(\tau_1 + \tau_2) \times 2 \times \omega_n \times \xi - 1}{K_p \times K_v \times K_n \times C2} = 315 \Omega$$

now R3 can be calculated:

$$R3 = \frac{\tau_1}{C2} - R4 = 2 \text{ k}\Omega.$$

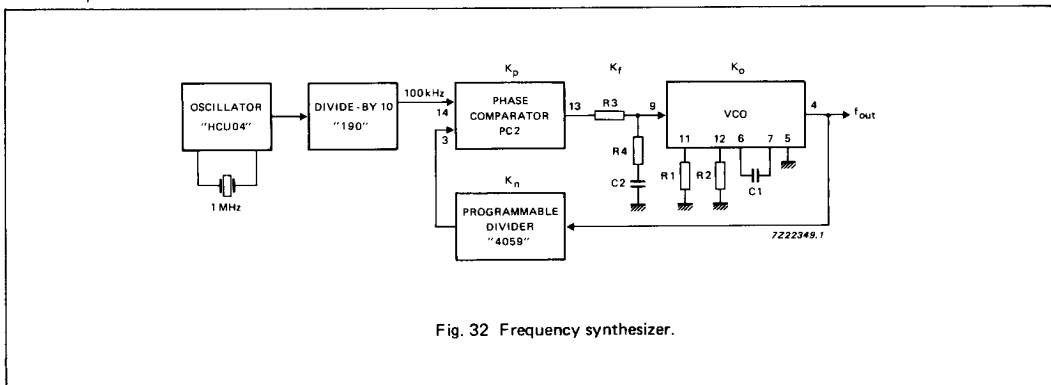

Fig. 32 Frequency synthesizer.

## Note

For an extensive description and application example please refer to application note ordering number 9398 649 90011. Also available a computer design program for PLL's ordering number 9398 961 10061.

查询"74HCT4046AD-T"供应商

APPLICATION INFORMATION (Continued)

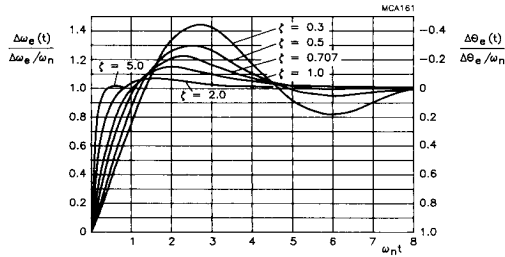

Fig. 33 Type 2, second order frequency step response.

Since the output frequency is proportional to the VCO control voltage, the PLL frequency response can be observed with an oscilloscope by monitoring pin 9 of the VCO. The average frequency response, as calculated by the Laplace method, is found experimentally by smoothing this voltage at pin 9 with a simple RC filter, whose time constant is long compared to the phase detector sampling rate but short compared to the PLL response time.

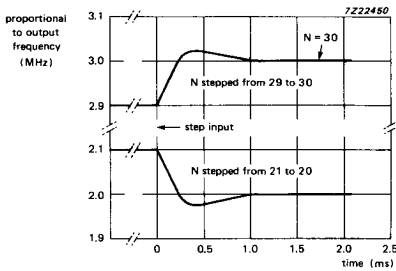

Fig. 34 Frequency compared to the time response.