

AS1332

Datasheet

650mA, Step-Down DC-DC Converter for RF Power Amplifiers

1 General Description

The AS1332 is a step-down DC-DC converter designed to power radiofrequency (RF) power amplifiers (PAs) from a single Li-Ion battery. The device also achieves high-performance in mobile phones and similar RF PA applications.

The AS1332 steps down an input voltage of 2.7V to 5.5V to output voltages ranging from 1.3V to 3.16V. Using a V_{CON} analog input, the output voltage is set for controlling power levels and efficiency of the RF PA.

The RF interferences are minimized due to the fixed-frequency PWM operation. The battery consumption is reduced to $0.01\mu A$ (typ.) during shutdown.

Because of the high switching frequencies (2 MHz) tiny surface-mount components can be used. Additional to the small size the amount is also small. Only three external components are required, an inductor and two ceramic capacitors.

The AS1332 is available in a 8-pin WL-CSP.

2 Key Features

- PWM Switching Frequency: 2MHz
- Single Lithium-Ion Cell Operation (2.7V to 5.5V)
- Dynamic Programmable Output Voltage (1.3V to 3.16V)
- Maximum load capability of 650mA
- High Efficiency (96% Typ at 3.6VIN, 3.16VOUT at 400mA) from internal synchronous rectification
- Current Overload Protection
- Thermal Overload Protection
- Soft Start
- 8-pin WL-CSP

3 Applications

The AS1332 is an ideal solution for cellular phones, hand-held radios, RF PC cards, and battery powered RF devices.

Figure 1. Typical Application Circuit

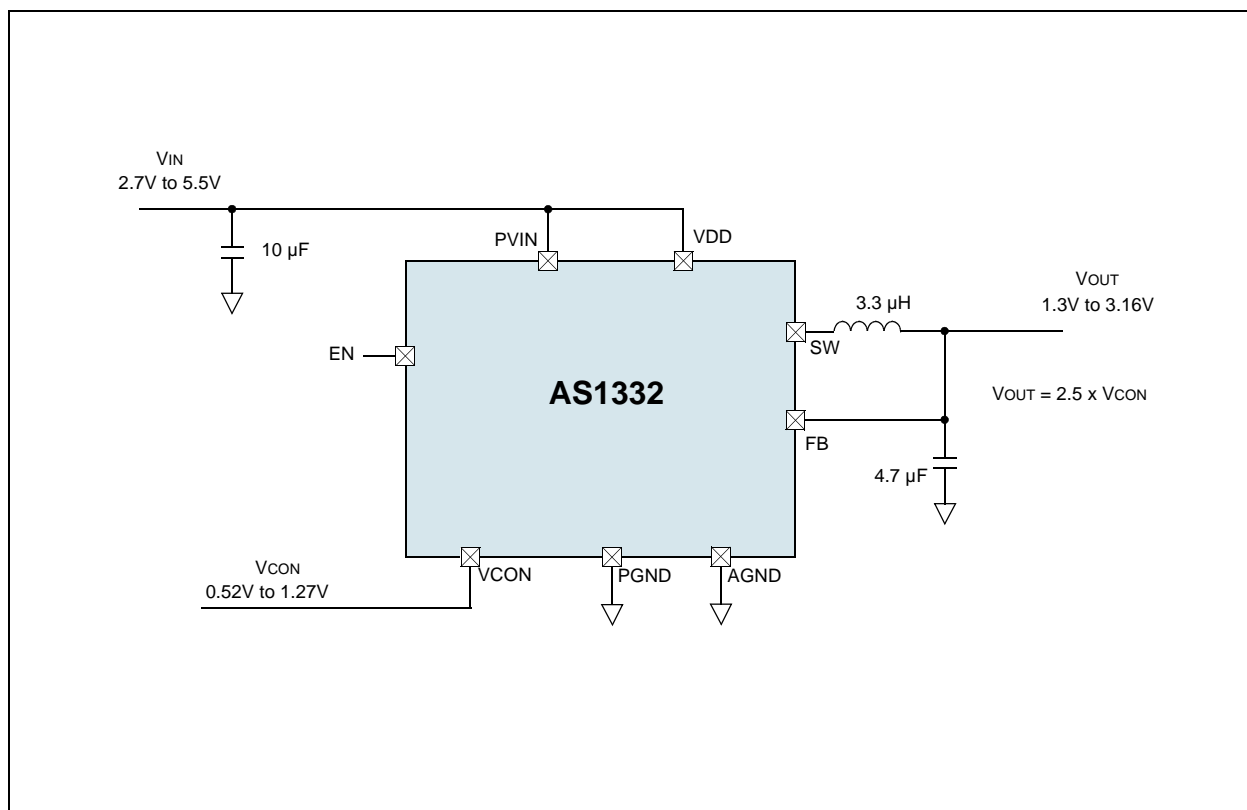

4 Pin Assignments

Figure 2. Pin Configuration

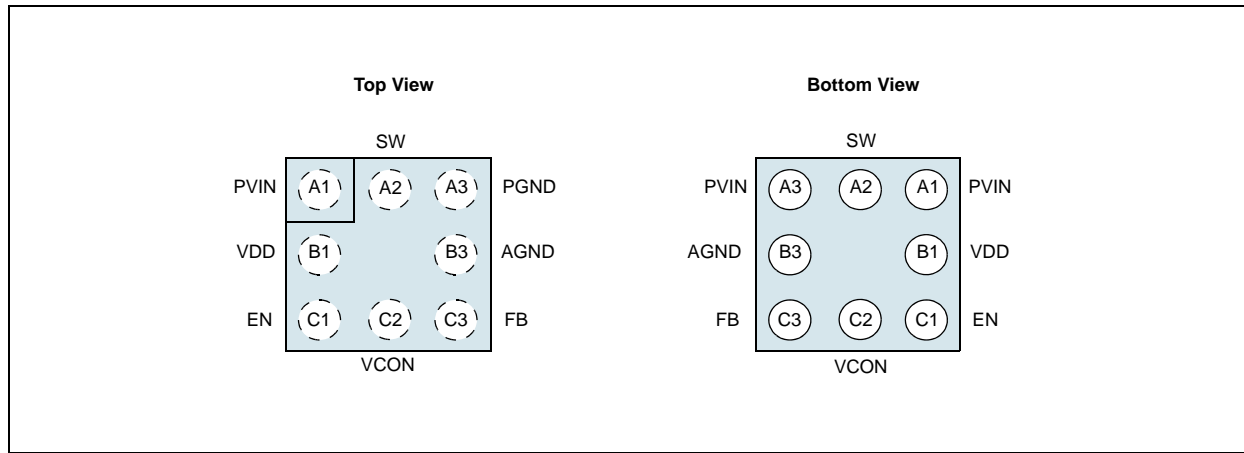

Pin Descriptions

Table 1. Pin Descriptions

Pin Name	Pin Number	Description
PVIN	A1	+2.7V to + 5.5V Power Supply Voltage. Input to the internal PFET switch.
VDD	B1	+2.7V to + 5.5V Analog Supply Input. Bypass this pin to GND with a $\geq 10\mu\text{F}$ capacitor.
EN	C1	Active-High Enable Input. Set this digital input high for normal operation. For shutdown, set low.
VCON	C2	Voltage Control Analog Input. VCON controls VOUT.
FB	C3	Feedback Pin. Connect to the output at the output filter capacitor.
AGND	B3	Analog and Control Ground
PGND	A3	Power Ground
SW	A2	Switch Pin. Switch node connection to the internal PFET switch and NFET synchronous rectifier. Limit specification of the AS1332.

5 Absolute Maximum Ratings

Stresses beyond those listed in [Table 2](#) may cause permanent damage to the device. These are stress ratings only, and functional operation of the device at these or any other conditions beyond those indicated in [Electrical Characteristics on page 4](#) is not implied. Exposure to absolute maximum rating conditions for extended periods may affect device reliability.

Table 2. Absolute Maximum Ratings

Parameter	Min	Max	Units	Comments
VDD, PVIN to AGND	-0.3	+7	V	
PGND to AGND	-0.3	+0.3	V	
EN, FB, VCON	AGND - 0.3	VDD + 0.3	V	7V max
SW	PGND - 0.3	PVIN + 0.3	V	
PVIN to VDD	-0.3	+0.3	V	
Operating Temperature Range	-40	+85	°C	
Junction Temperature (T _{J-MAX})		+150	°C	
Storage Temperature Range	-65	+150	°C	
Maximum Lead Temperature (soldering, 10sec)		+260	°C	
ESD Rating				
Human Body Model		2	kV	HBM MIL-Std. 883E 3015.7 methods
Operating Ratings				
Input Voltage Range	2.7	5.5	V	
Recommended Load Current		650	mA	
Junction Temperature (T _J) Range	-40	+125	°C	
Ambient Temperature (T _A) Range	-40	+85	°C	<p>In applications where high power dissipation and/or poor package thermal resistance is present, the maximum ambient temperature may have to be derated.</p> <p>Maximum ambient temperature (T_{A-MAX}) is dependent on the maximum operating junction temperature (T_{J-MAX-OP} = 125°C), the maximum power dissipation of the device in the application (P_{D-MAX}), and the junction-to ambient thermal resistance of the part/package in the application (θ_{JA}), as given by the following equation: T_{A-MAX} = T_{J-MAX-OP} - (θ_{JA} × P_{D-MAX}).</p>

6 Electrical Characteristics

$T_A = T_J = -40^{\circ}\text{C}$ to $+85^{\circ}\text{C}$; $PVIN = VDD = EN = 3.6\text{V}$, unless otherwise noted. Typ values are at $T_A = 25^{\circ}\text{C}$.

Table 3. Electrical Characteristics

Symbol	Parameter	Conditions	Min	Typ	Max	Units
$V_{FB,MIN}$	Feedback Voltage at Minimum Setting	$V_{CON} = 0.4\text{V}$	1.21	1.30	1.39	V
V_{FB}	Feedback Voltage	$V_{CON} = 1.1\text{V}$	2.693	2.75	2.807	V
$V_{FB,MAX}$	Feedback Voltage at Maximum Setting	$V_{CON} = 1.4\text{V}$	3.03	3.17	3.29	V
I_{SHDN}^1	Shutdown Supply Current	$EN = SW = V_{CON} = 0\text{V}$		0.01	2	μA
I_Q^2	DC Bias Current into VDD	$V_{CON} = 1\text{V}$, $FB = 0\text{V}$, No Switching		1	1.4	mA
DC-DC Switches						
$I_{LIM,PFET}$	Switch Peak Current Limit	Current limit is built-in, fixed, and not adjustable.	935	1100	1200	mA
$R_{DSON(P)}$	Pin-Pin Resistance for PFET	$I_{SW} = 200\text{mA}$; $T_A = +25^{\circ}\text{C}$		140	200	$\text{m}\Omega$
		$I_{SW} = 200\text{mA}$			230	
$R_{DSON(N)}$	Pin-Pin Resistance for NFET	$I_{SW} = -200\text{mA}$; $T_A = +25^{\circ}\text{C}$		300	415	$\text{m}\Omega$
		$I_{SW} = -200\text{mA}$			485	
Control Inputs						
$V_{IH,EN}$	Logic High Input Threshold		1.2			V
$V_{IL,EN}$	Logic Low Input Threshold				0.5	V
$I_{PIN,ENABLE}$	Pin Pull Down Current			5	7	μA
$V_{CON,min}$	V_{CON} Threshold Commanding $V_{FB,MIN}$	V_{CON} swept down	0.484	0.52	0.556	V
$V_{CON,max}$	V_{CON} Threshold Commanding $V_{FB,MAX}$	V_{CON} swept up	1.208	1.27	1.312	V
Z_{CON}	V_{CON} Input Resistance ³	$T_A = +25^{\circ}\text{C}$	100			$\text{k}\Omega$
I_{CON}	Control Pin Leakage Current		-10		10	μA
Gain	V_{CON} to V_{OUT} Gain	$0.556\text{V} \leq V_{CON} \leq 1.208\text{V}$		2.5		V/V
Oscillator						
F_{OSC}	Internal Oscillator Frequency		1.8	2	2.2	MHz

1. Shutdown current includes leakage current of PFET.
2. I_Q specified here is when the part is operating at 100% duty cycle.
3. Derived by input leakage test.

System Characteristics

$T_A = 25^\circ\text{C}$; $P_{VIN} = V_{DD} = EN = 3.6\text{V}$, unless otherwise noted. The following parameters are verified by characterisation and are not production tested.

Table 4. System Characteristics

Symbol	Parameter	Conditions	Min	Typ	Max	Units
Control Inputs						
T_{RESP}	Time for V_{OUT} to rise from 1.3V to 3.16V	$V_{IN} = 4.2\text{V}$, $C_{OUT} = 4.7\mu\text{F}$, $L = 3.3\mu\text{H}$, $R_{LOAD} = 5\Omega$		20	30	μs
	Time for V_{OUT} to fall from 3.16V to 1.3V	$V_{IN} = 4.2\text{V}$, $C_{OUT} = 4.7\mu\text{F}$, $L = 3.3\mu\text{H}$, $R_{LOAD} = 10\Omega$		20	30	
C_{CON}	V_{CON} Input Capacitance	$V_{CON} = 1\text{V}$, Test frequency = 100 kHz			20	pF
Linearity	Linearity in Control Range 0.556V to 1.208V	$V_{IN} = 3.6\text{V}$, Monotonic in nature	-3		+3	%
T_{ON}	Turn-On Time (time for output to reach 3.16V from enable low to high transition)	$EN = \text{Low to High}$, $V_{IN} = 4.2\text{V}$, $V_{OUT} = 3.16\text{V}$, $C_{OUT} = 4.7\mu\text{F}$, $I_{OUT} \leq 1\text{mA}$		210	750	μs
Performance Parameters						
η	Efficiency ($L = 3.3\mu\text{H}$, $DCR \leq 100\text{m}\Omega$)	$V_{IN} = 3.6\text{V}$, $V_{OUT} = 1.3\text{V}$, $I_{OUT} = 90\text{mA}$		87		%
		$V_{IN} = 3.6\text{V}$, $V_{OUT} = 3.16\text{V}$, $I_{OUT} = 400\text{mA}$		96		
$V_{OUT-ripple}$	Ripple voltage, PWM mode ¹	$V_{IN} = 3\text{V to } 4.5\text{V}$, $V_{OUT} = 1.3\text{V}$, $I_{OUT} = 10\text{mA to } 400\text{mA}$		10		mVp-p
Line_tr	Line transient response	$V_{IN} = 600\text{mV}$ perturbation, over V_{in} range 3V to 5.5V; $T_{RISE} = T_{FALL} = 10\mu\text{s}$, $V_{OUT} = 1.3\text{V}$, $I_{OUT} = 100\text{mA}$		50		mVp-k
Load_tr	Load transient response	$V_{IN} = 3.1/3.6/4.5\text{V}$, $V_{OUT} = 1.3\text{V}$, transients up to 100mA, $T_{RISE} = T_{FALL} = 10\mu\text{s}$		50		mVp-k
PSRR	$V_{IN} = 3.6\text{V}$, $V_{OUT} = 1.3\text{V}$, $I_{OUT} = 100\text{mA}$	sine wave perturbation frequency = 10kHz, amplitude = 100mVp-p		40		dB

1. Ripple voltage should be measured at C_{OUT} electrode on good layout PC board and under condition using suggested inductors and capacitors.

[查询"AS1332-BWLT"供应商](#)

7 Typical Operating Characteristics

Circuit in Figure 31 on page 12, $P_{VIN} = V_{DD} = EN = 3.6V$, $L = 3.3\mu H$ (LPS4018-332ML_), $C_{IN} = 10\mu F$ (GRM21BR61C106KA01), $C_{OUT} = 4.7\mu F$ (GRM32ER71H475KA88) unless otherwise noted;

Figure 3. I_Q vs. V_{IN} ; $V_{CON} = 2V$, $FB = 0V$, no switching

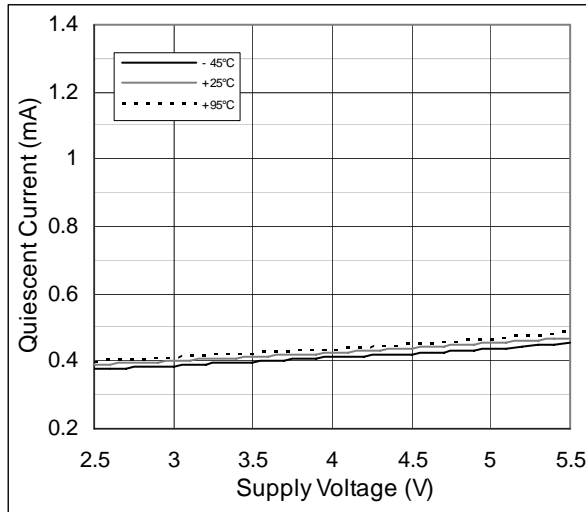

Figure 4. I_{SHDN} vs. Temperature; $V_{CON} = 0V$, $EN = 0V$

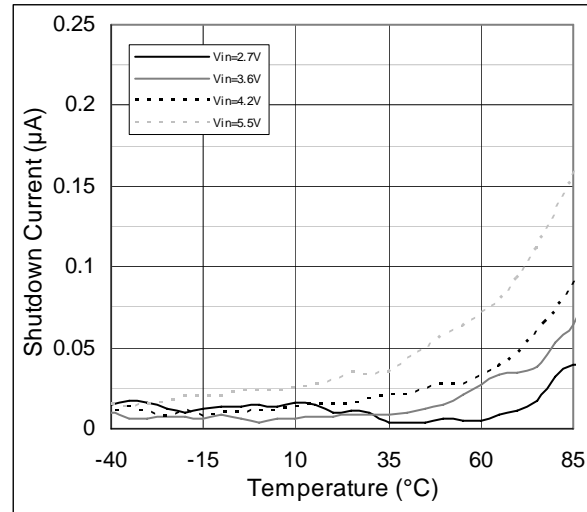

Figure 5. Switching Frequency Variation vs. Temp.

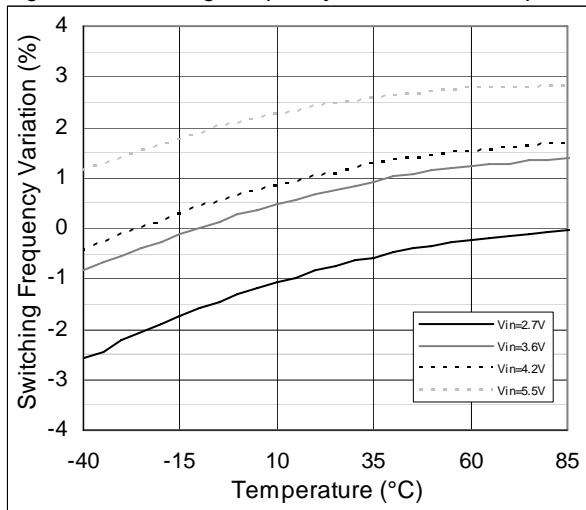

Figure 6. V_{OUT} vs. V_{IN} ; $V_{OUT} = 1.3V$

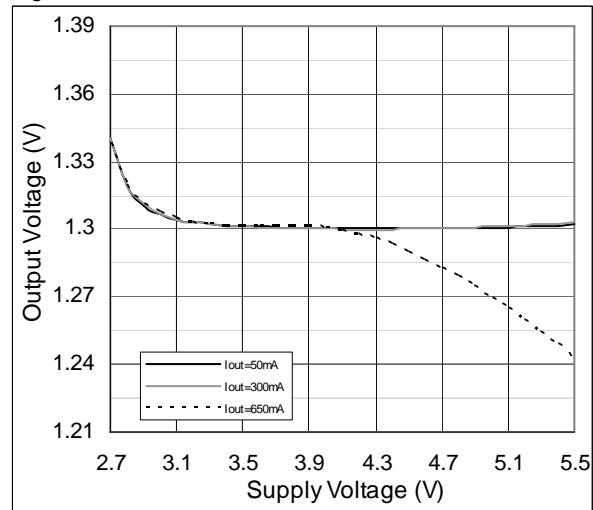

Figure 7. V_{OUT} vs. Temp; $V_{IN} = 3.6V$, $V_{OUT} = 1.3V$

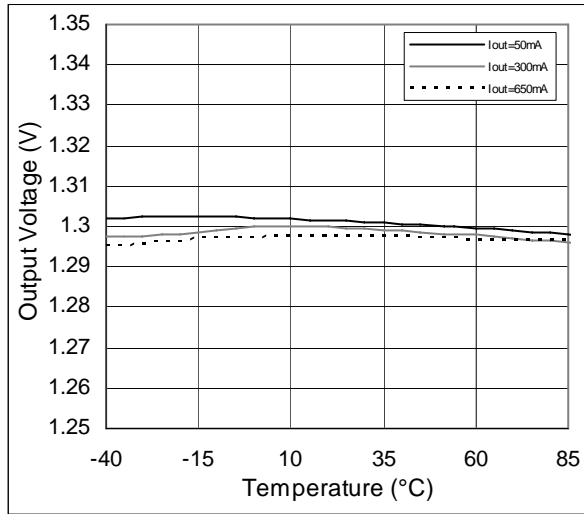

Figure 8. V_{OUT} vs. Temp; $V_{IN} = 3.6V$, $V_{OUT} = 3.16V$

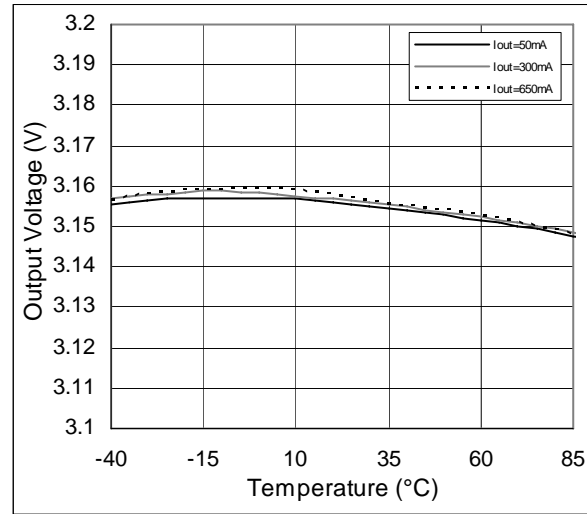

Figure 9. Switch Peak Current Limit vs. Temp.

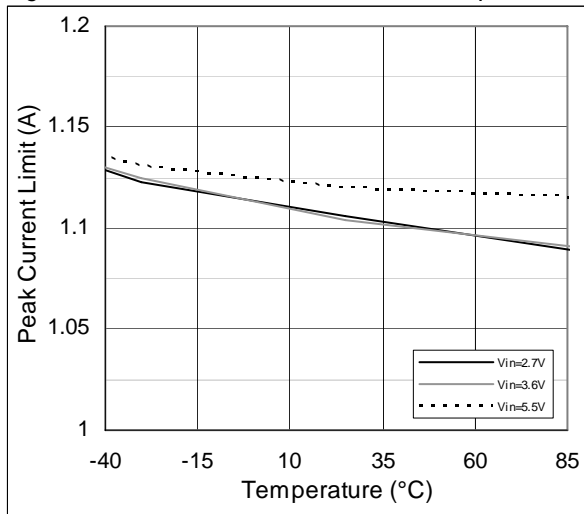

Figure 10. V_{CON} vs. V_{OUT} ; $V_{IN} = 4.2V$, $R_{LOAD} = 8\Omega$

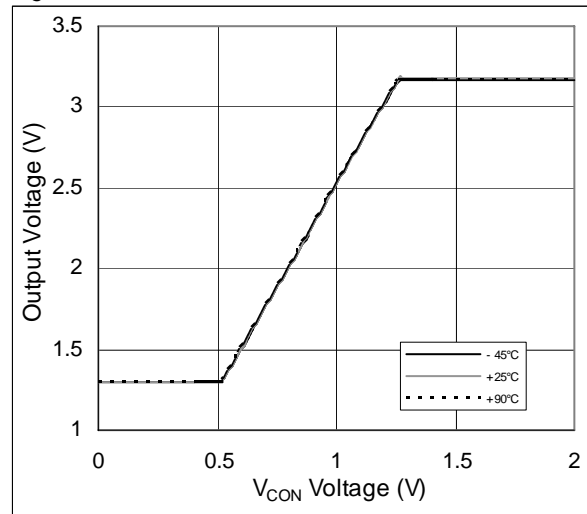

Figure 11. Efficiency vs. V_{OUT} ; $V_{IN} = 3.6V$

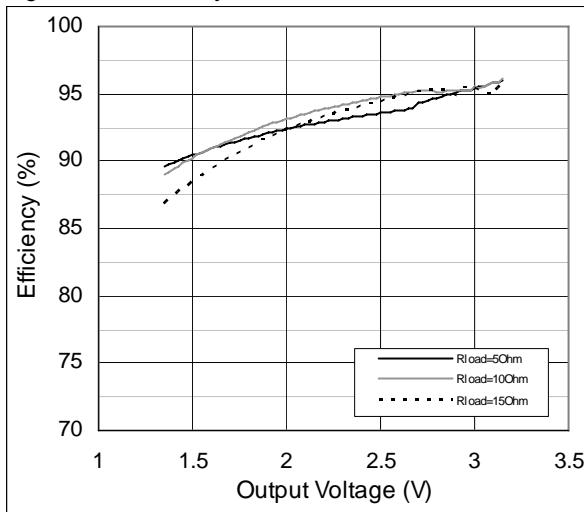
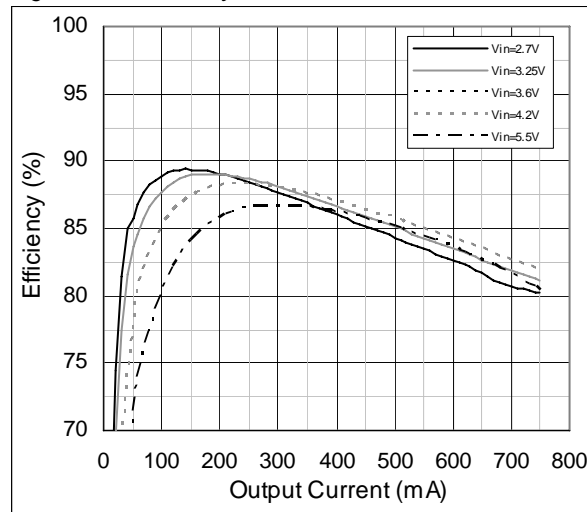

Figure 12. Efficiency vs. I_{OUT} ; $V_{OUT} = 1.3V$



[查询"AS1332-BWLT"供应商](#)

Figure 13. Efficiency vs. I_{OUT} ; $V_{OUT} = 3.09V$

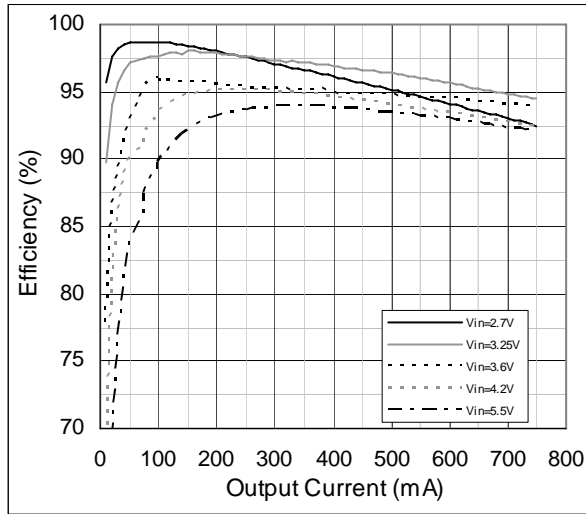

Figure 14. Load Transient Response; $V_{IN} = 3.6V$, $V_{OUT} = 1.3V$

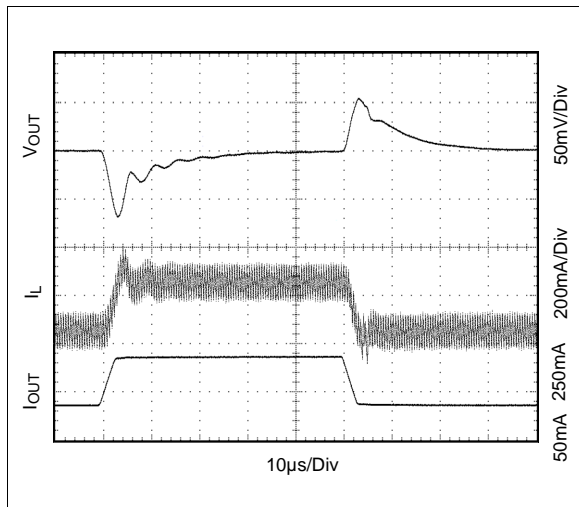

Figure 15. Startup; $V_{IN} = 3.6V$, $V_{OUT} = 1.3V$, $I_{OUT} < 1mA$, $R_{LOAD} = 4.7k\Omega$

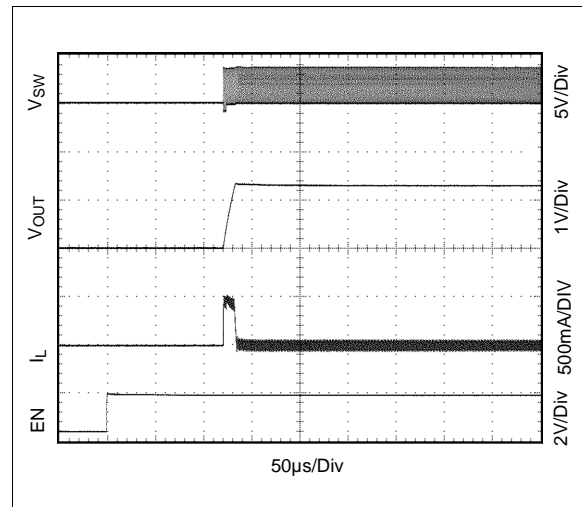

Figure 16. Startup; $V_{IN} = 4.2V$, $V_{OUT} = 3.16V$, $I_{OUT} < 1mA$, $R_{LOAD} = 4.7k\Omega$

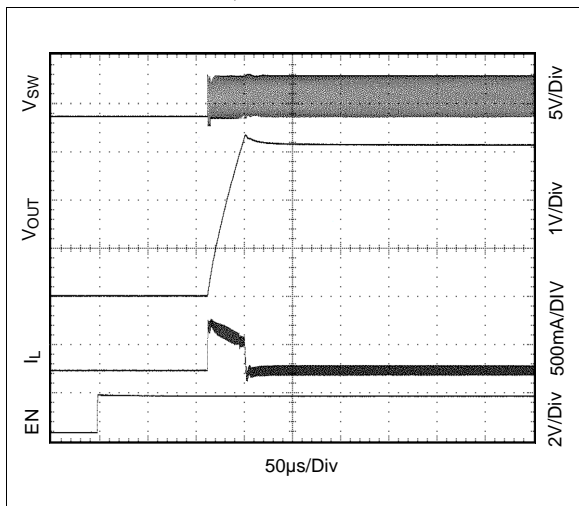
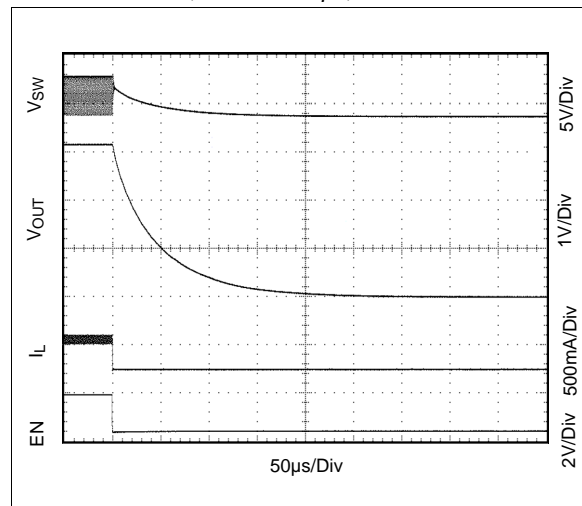

Figure 17. Shutdown Response; $V_{IN} = 4.2V$, $V_{OUT} = 3.16V$, $C_{OUT} = 4.7\mu F$, $R_{LOAD} = 10\Omega$



查询"AS1332-BWLT"供应商

Figure 18. V_{CON} Voltage Response; $V_{IN} = 4.2V$, $V_{CON} = 0V$ to $1.4V$, $R_{LOAD} = 10\Omega$

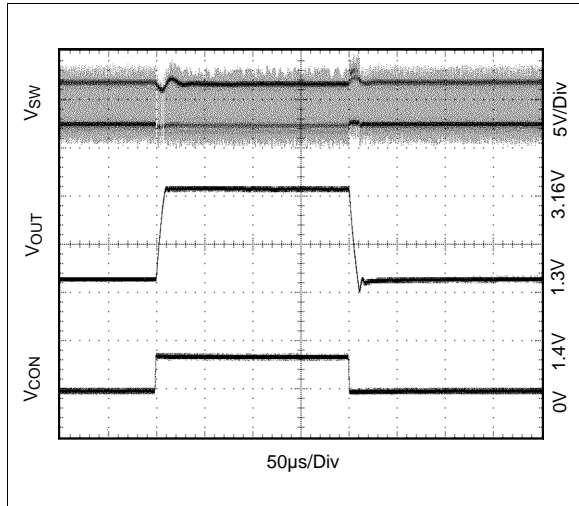

Figure 19. V_{CON} and Load Transient; $V_{IN} = 4.2V$, $V_{CON} = 0V$ to $1.4V$, $15\Omega/8\Omega$, same time

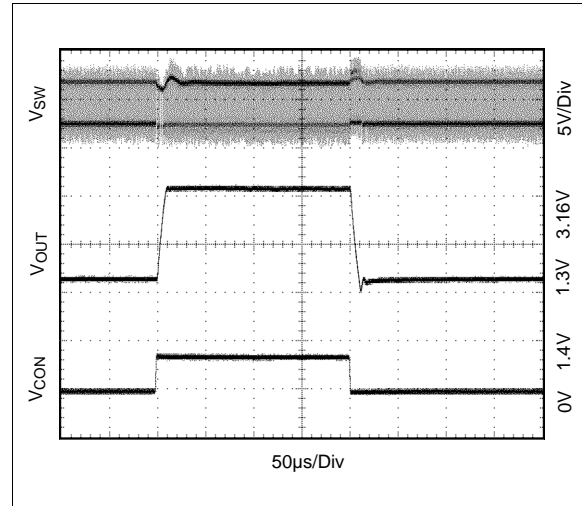

Figure 20. Timed Current Limit Response; $V_{IN} = 3.6V$, $V_{OUT} = 1.3V$, $R_{LOAD} = 10\Omega$

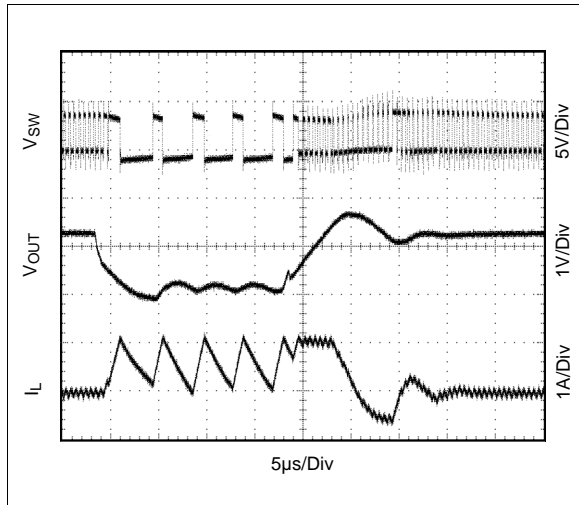

Figure 21. Output Voltage Ripple; $V_{IN} = 3.6V$, $V_{OUT} = 1.3V$, $I_{OUT} = 200mA$

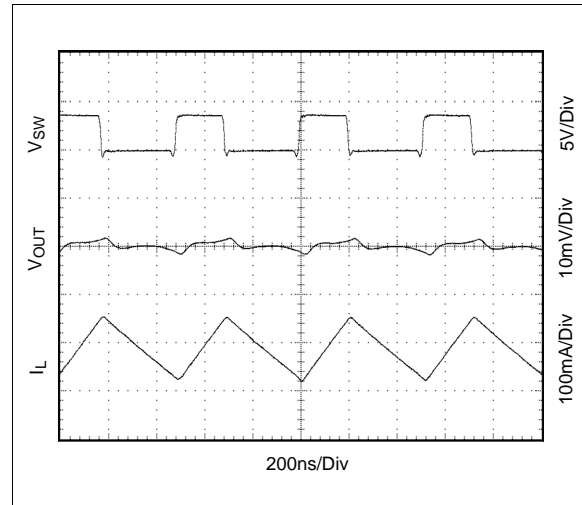

Figure 22. V_{OUT} Ripple in Skip Mode; $V_{IN} = 3.547V$, $V_{OUT} = 3.16V$, $R_{LOAD} = 5\Omega$

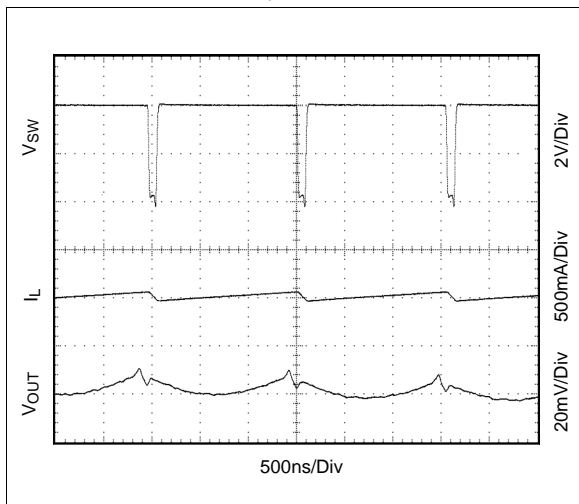

Figure 23. $R_{DS(on)}$ (P-Chanel) vs. Temperature; $I_{SW} = 200mA$

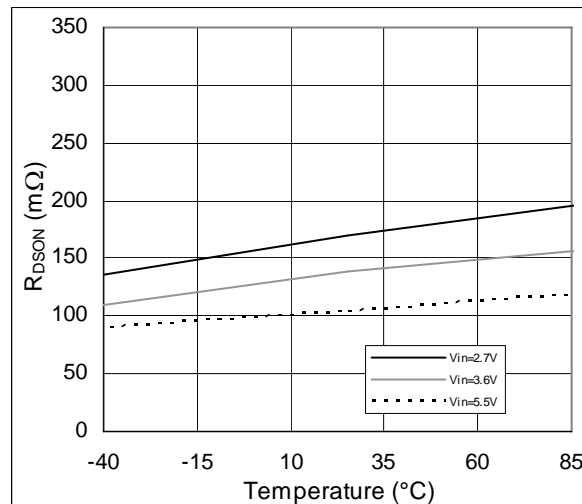

Figure 24. $R_{DS(on)}$ (N-Chanel) vs. Temp.; $I_{sw}=-200mA$

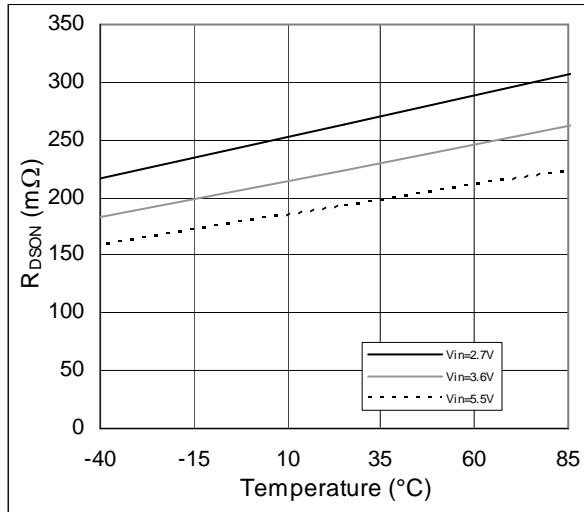

Figure 25. EN High Threshold vs. V_{IN}

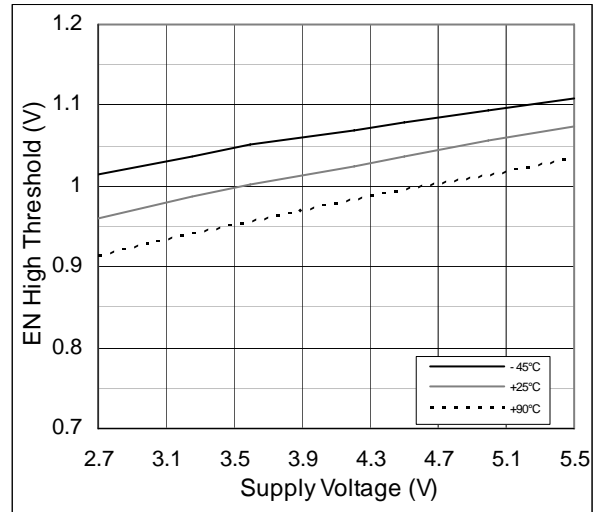

Figure 26. V_{CON} Threshold min vs. V_{IN}

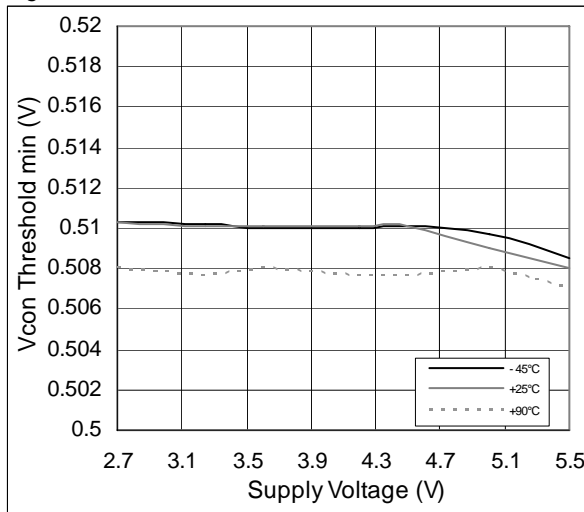

Figure 27. V_{CON} Threshold max vs. V_{IN}

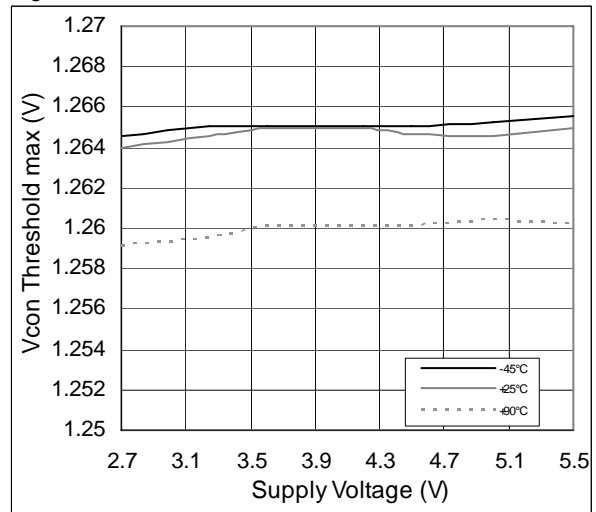

Figure 28. V_{FB} min vs. V_{IN} ; $V_{CON} = 0.4V$, $R_{LOAD} = 10\Omega$

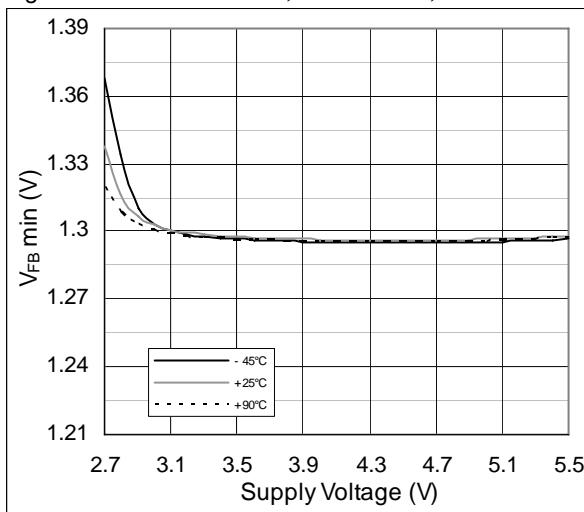
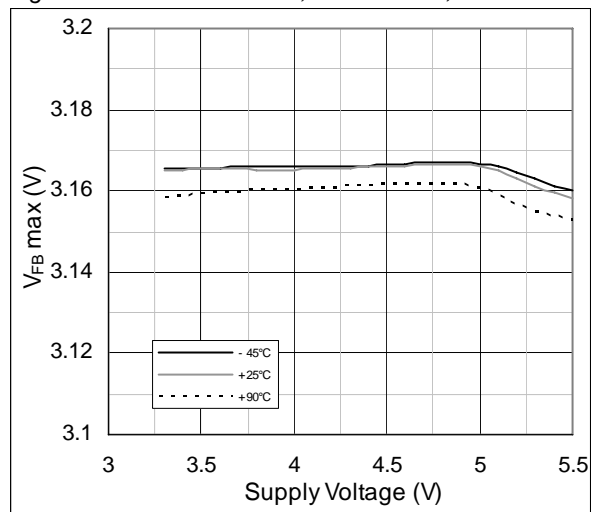

Figure 29. V_{FB} max vs. V_{IN} ; $V_{CON} = 0.4V$, $R_{LOAD} = 10\Omega$



8 Detailed Description

For driving RF power amplifiers in portable devices and battery powered RF devices the AS1332 is a very suitable DC-DC converter. The AS1332 features current overload protection, thermal overload shutdown and soft start. Besides these features the device also displays the following characteristics:

- Current-mode buck architecture with synchronous rectification for high efficiency.
- Operation at maximum efficiency over a wide range of power levels from a single Li-Ion battery cell.
- The maximum load capability of 650mA is provided in PWM mode, wherein the maximum load range may vary depending on input voltage, output voltage and the selected inductor.
- Efficiency is of around 96% for a 400mA load with 3.16V output and 3.6V input.
- For longer battery life, the output voltage can be dynamically programmable from 1.3V (typ) to 3.16V (typ) by adjusting the voltage on the control pin without the need for external feedback resistors.

Figure 30. AS1332 Block Diagram

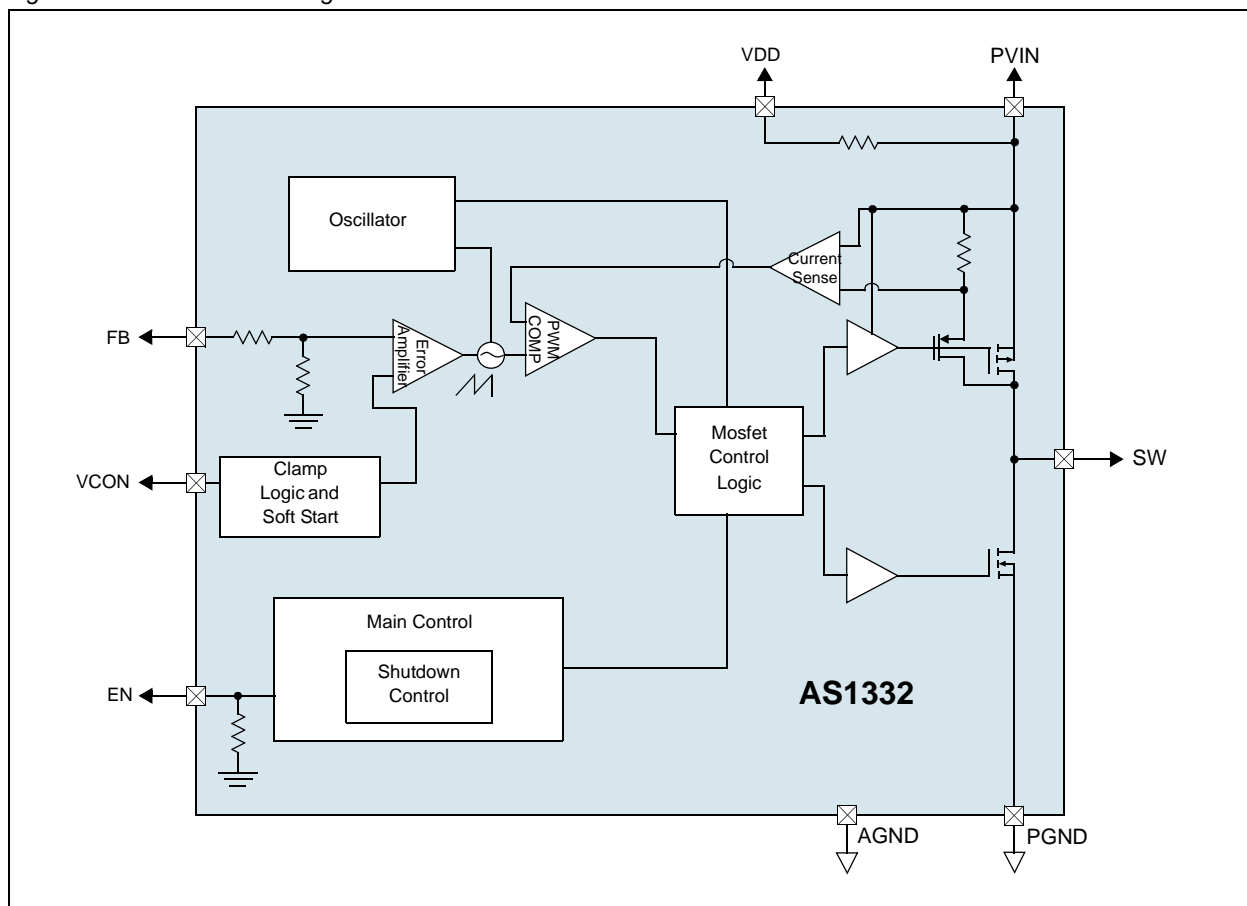

AS1332 is fabricated using a 8-pin WL-CSP, which requires special design considerations for implementation. Its fine bump pitch requires careful board design and precision assembly equipment. This package offers the smallest possible size, for space-critical applications such as cell phones, where board area is an important design consideration. The size of the external components is reduced by using a high switching frequency (2MHz). For implementation only three external power components are required (see Figure 1 on page 1). The 8-pin WL-CSP package is appropriate for opaque case applications, where its edges are not subject to high intensity ambient red or infrared light. Also the system controller should set EN low during power-up and other low supply voltage conditions. See Shutdown Mode on page 13.

Figure 31. Typical Operating System Circuit

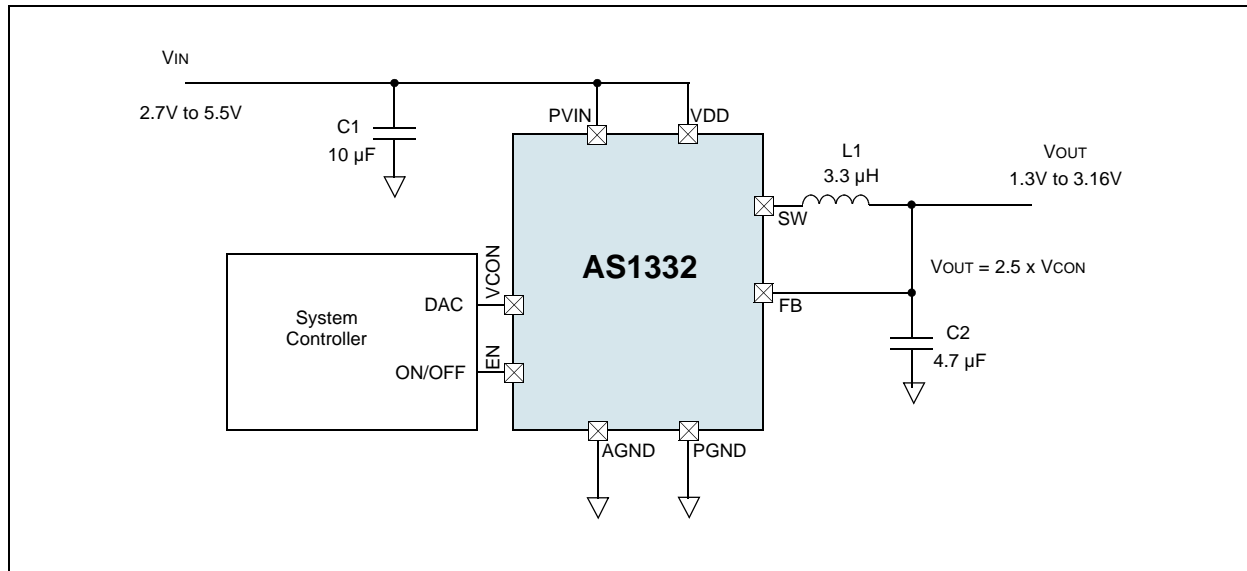

Operating the AS1332

AS1332's control block turns on the internal PFET (P-channel MOSFET) switch during the first part of each switching cycle, thus allowing current to flow from the input through the inductor to the output filter capacitor and load. The inductor limits the current to a ramp with a slope of around $(V_{IN} - V_{OUT}) / L$, by storing energy in a magnetic field.

During the second part of each cycle, the controller turns the PFET switch off, blocking current flow from the input, and then turns the NFET (N-channel MOSFET) synchronous rectifier on. As a result, the inductor's magnetic field collapses, generating a voltage that forces current from ground through the synchronous rectifier to the output filter capacitor and load.

While the stored energy is transferred back into the circuit and depleted, the inductor current ramps down with a slope around V_{OUT} / L . The output filter capacitor stores charge when the inductor current is high, and releases it when low, smoothing the voltage across the load. The output voltage is regulated by modulating the PFET switch on time to control the average current sent to the load. The effect is identical to sending a duty-cycle modulated rectangular wave formed by the switch and synchronous rectifier at SW to a low-pass filter formed by the inductor and output filter capacitor.

The output voltage is equal to the average voltage at the SW pin.

While in operation, the output voltage is regulated by switching at a constant frequency and then modulating the energy per cycle to control power to the load. Energy per cycle is set by modulating the PFET switch on-time pulse width to control the peak inductor current. This is done by comparing the signal from the current-sense amplifier with a slope compensated error signal from the voltage-feedback error amplifier. At the beginning of each cycle, the clock turns on the PFET switch, causing the inductor current to ramp up. When the current sense signal ramps past the error amplifier signal, the PWM comparator turns off the PFET switch and turns on the NFET synchronous rectifier, ending the first part of the cycle.

If an increase in load pulls the output down, the error amplifier output increases, which allows the inductor current to ramp higher before the comparator turns off the PFET. This increases the average current sent to the output and adjusts for the increase in the load. Before appearing at the PWM comparator, a slope compensation ramp from the oscillator is subtracted from the error signal for stability of the current feedback loop. The minimum on time of PFET in PWM mode is 50ns (typ.)

Internal Synchronous Rectifier

To reduce the rectifier forward voltage drop and the associated power loss, the AS1332 uses an internal NFET as a synchronous rectifier. The big advantage of a synchronous rectification is the higher efficiency in a condition where the output voltage is low compared to the voltage drop across an ordinary rectifier diode. During the inductor current down slope in the second part of each cycle the synchronous rectifier is turned on. Before the next cycle the synchronous rectifier is turned off.

There is no need for an external diode because the NFET is conducting through its intrinsic body diode during the transient intervals before it turns on.

Dynamic Output Voltage Programming

Because of the dynamically adjustable output voltage of the AS1332 there is no need for external feedback resistors. Through changing the voltage at the analog pin V_{CON} , the output voltage is set from $V_{FB,MIN}$ to $V_{FB,MAX}$. This is a very helpful feature because the supply voltage of a PA application can be changed due to the operation mode. For example, during the data transmission from a handset peak power is needed. In the other states the transmitting power can be reduced to ensure a longer battery lifetime.

Shutdown Mode

If EN is set to high ($>1.2V$) the AS1332 is in normal operation mode. During power-up and when the power supply is less than 2.7V minimum operating voltage, the chip should be turned off by setting EN low. In shutdown mode the following blocks of the AS1332 are turned off, PFET switch, NFET synchronous rectifier, reference voltage source, control and bias circuitry. The AS1332 is designed for compact portable applications, such as mobile phones where the system controller controls operation mode for maximizing battery life and requirements for small package size outweigh the additional size required for inclusion of UVLO (Under Voltage Lock-Out) circuitry.

Note: Setting the EN digital pin low ($<0.5V$) places the AS1332 in a $0.01\mu A$ (typ.) shutdown mode.

Thermal Overload Protection

To prevent the AS1332 from short-term misuse and overload conditions the chip includes a thermal overload protection. To block the normal operation mode the device is turning the PFET and the NFET off in PWM mode as soon as the junction temperature exceeds $150^{\circ}C$. To resume the normal operation the temperature has to drop below $125^{\circ}C$.

Note: Continuing operation in thermal overload conditions may damage the device and is considered bad practice.

Current Limiting

If in the PWM mode the cycle-by-cycle current limit of 1.2A (max.) is reached the current limit feature takes place and protects the device and the external components. A timed current limiting mode is working when a load pulls the output voltage down to approximately 0.375V. In this timed current limit mode the inductor current is forced to ramp down to a safe value. This is achieved by turning off the internal PFET switch and delaying the start of the next cycle for 3.5us. The synchronous rectifier is also turned off in the timed current limit mode.

The advantage of the timed current limit mode is to prevent the device of the loss of the current control.

9 Application Information

Through setting the voltage on the VCON pin (see Table 5) the output voltage of the AS1332 can be programmed from 1.3V (typ) to 3.16V (typ). This feature eliminates the need for external feedback resistors.

If the voltage on the control pin varies from 0.556V to 1.208V, the output voltage will change according to the equation stated in Table 5. The output voltage is regulated at $V_{FB,MIN}$ as long as the voltage on the control pin is less than 0.484V. If the voltage on the control pin is higher than 1.312V, the output voltage is regulated at $V_{FB,MAX}$.

Before the control voltage is fed to the error amplifier inputs, the control voltage is clamped internal in the device.

Table 5. Output Voltage Selection

VCON (V)	VOUT (V)
$V_{CON} \leq 0.484$	$V_{FB,MIN}$
$0.556 < V_{CON} < 1.208$	$V_{OUT} = 2.5 \times V_{CON}$
$V_{CON} \geq 1.312$	$V_{FB,MAX}$

External Component Selection

Inductor Selection

For the external inductor, a 3.3 μ H inductor is recommend. Minimum inductor size is dependant on the desired efficiency and output current. Inductors with low core losses and small DCR at 2MHz are recommended.

Table 6. Recommended Inductors

Part Number	L	DCR	Current Rating	Dimensions (L/W/T)	Manufacturer
LPS4018-222ML_	2.2 μ H	0.070 Ω	2.9A	3.9x3.9x1.7mm	Coilcraft www.coilcraft.com
LPS4018-332ML_	3.3 μ H	0.080 Ω	2.4A	3.9x3.9x1.7mm	
LPS4018-472ML_	4.7 μ H	0.125 Ω	1.9A	3.9x3.9x1.7mm	

Capacitor Selection

A 10 μ F capacitor is recommend for C_{IN} as well as a 4.7 μ F for C_{OUT}. Small-sized X5R or X7R ceramic capacitors are recommend as they retain capacitance over wide ranges of voltages and temperatures.

Input and Output Capacitor Selection

Low ESR input capacitors reduce input switching noise and reduce the peak current drawn from the battery. Also low ESR capacitors should be used to minimize V_{OUT} ripple. Multi-layer ceramic capacitors are recommended since they have extremely low ESR and are available in small footprints.

For input decoupling the ceramic capacitor should be located as close to the device as practical. A 4.7 μ F input capacitor is sufficient for most applications. Larger values may be used without limitations.

A 2.2 μ F to 10 μ F output ceramic capacitor is sufficient for most applications. Larger values up to 22 μ F may be used to obtain extremely low output voltage ripple and improve transient response.

Table 7. Recommended Capacitors for the Step-Down Converter

Part Number	C	Voltage	Type	Size	Manufacturer
GRM21BR60J226ME39	22 μ F	6.3V	X5R	0805	Murata www.murata.com
GRM21BR60J106KE01	10 μ F	6.3V	X5R	0805	
GRM21BR61C475KA88	4.7 μ F	16V	X5R	0805	
GRM188R61C225KE15	2.2 μ F	16V	X5R	0603	
GRM188R61A225KE34	2.2 μ F	10V	X5R	0603	
C0603C475K8PAC7867	4.7 μ F	10V	X5R	0603	KEMET www.kemet.com

EN Pin Control

Drive the EN pin using the system controller to turn the AS1332 ON and OFF. Use a comparator, Schmidt trigger or logic gate to drive the EN pin. Set EN high (>1.2V) for normal operation and low (<0.5V) for a 0.01 μ A (typ.) shutdown mode. Set EN low to turn off the AS1332 during power-up and under voltage conditions when the power supply is less than the 2.7V minimum operating voltage. The part is out of regulation when the input voltage is less than 2.7V.

Layout Considerations

The AS1332 converts higher input voltage to lower output voltage with high efficiency. This is achieved with an inductor based switching topology. During the first half of the switching cycle, the internal PMOS switch turns on, the input voltage is applied to the inductor, and the current flows from PVDD line to the output capacitor (C2) through the inductor. During the second half cycle, the PMOS turns off and the internal NMOS turns on. The inductor current continues to flow via the inductor from the device PGND line to the output capacitor (C2). Referring to [Figure 32](#), the AS1332 has two major current loops where pulse and ripple current flow. The loop shown in the left hand side is most important, because pulse current shown in [Figure 32](#) flows in this path. The right hand side is next. The current waveform in this path is triangular, as shown in [Figure 32](#). Pulse current has many high-frequency components due to fast di/dt. Triangular ripple current also has wide high-frequency components. Board layout and circuit pattern design of these two loops are the key factors for reducing noise radiation and stable operation. Other lines, such as from battery to C1(+) and C2(+) to load, are almost DC current, so it is not necessary to take so much care. Only pattern width (current capability) and DCR drop considerations are needed.

Figure 32. Current Loop

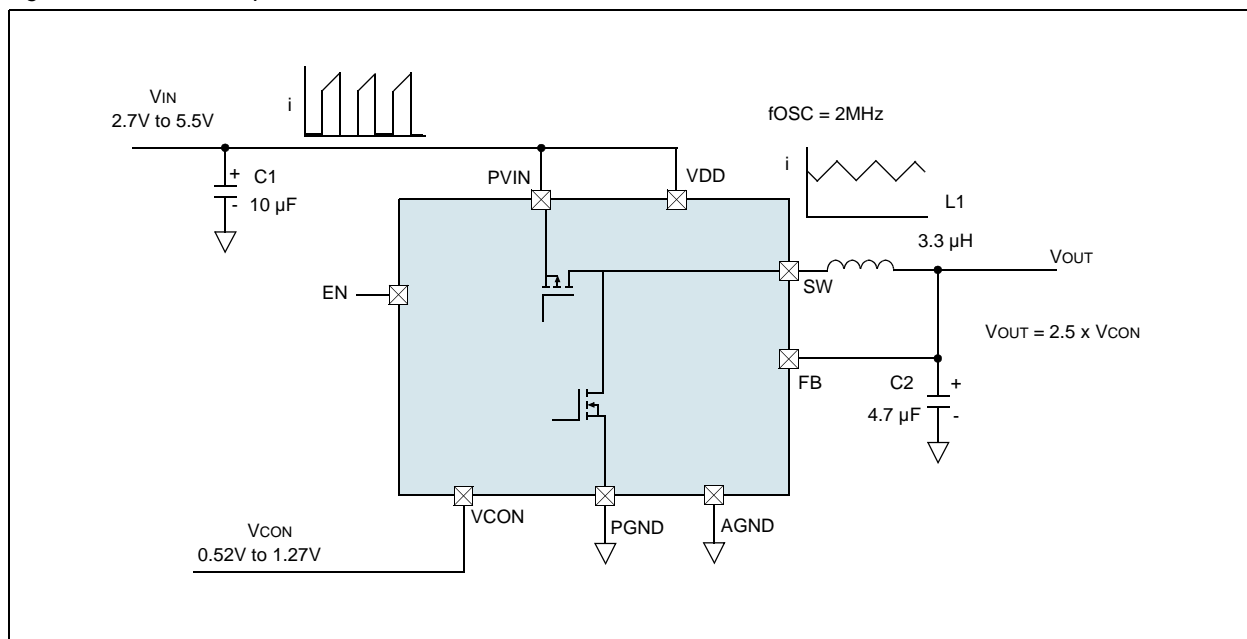

[查询"AS1332-BWLT"供应商](#)

10 Package Drawings and Markings

The device is available in a 8-pin WL-CSP

Figure 33. Package Drawings

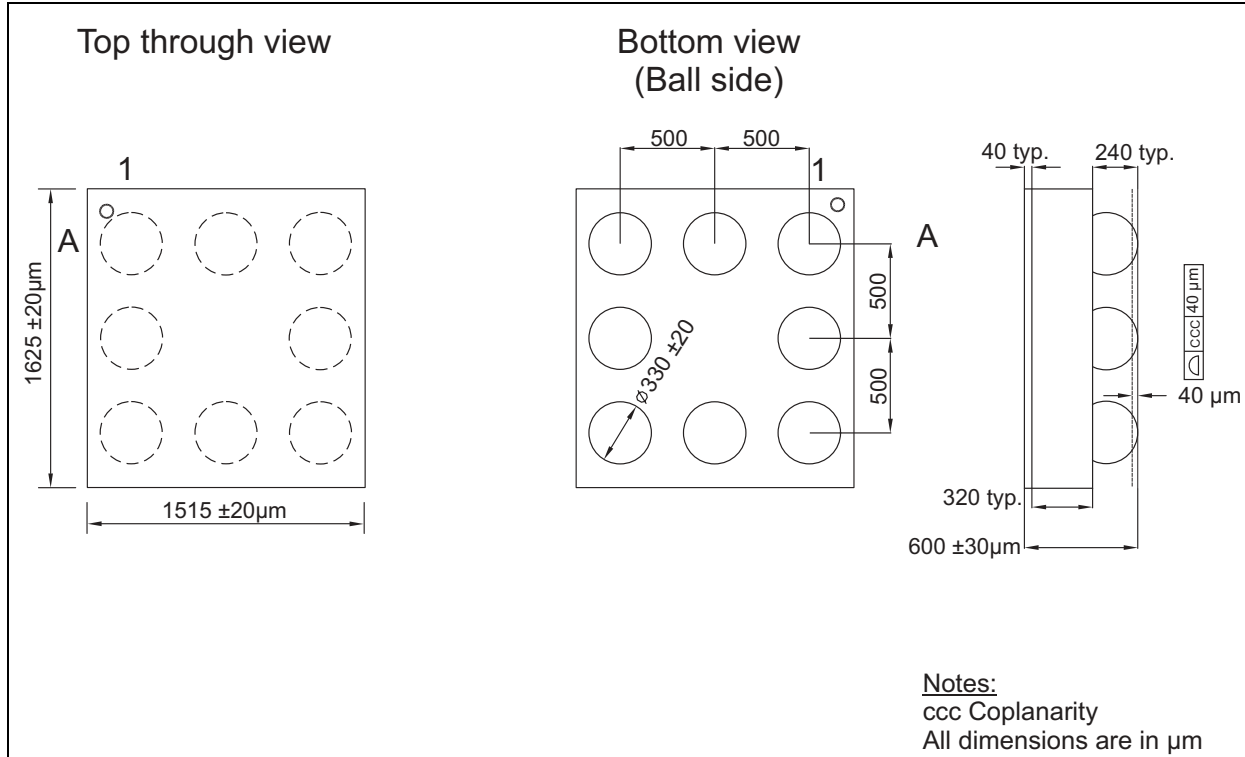

[查询"AS1332-BWLT"供应商](#)

11 Ordering Information

The device is available as the standard products listed in [Table 8](#).

Table 8. Ordering Information

Part Number	Marking	Description	Delivery Form	Package
AS1332-BWLT	ASQW	650mA, DC-DC Step-Down for RF	Tape and Reel	8-pin WL-CSP

All devices are RoHS compliant and free of halogene substances.

Copyrights

Copyright © 1997-2009, austriamicrosystems AG, Schloss Premstaetten, 8141 Unterpremstaetten, Austria-Europe. Trademarks Registered ®. All rights reserved. The material herein may not be reproduced, adapted, merged, translated, stored, or used without the prior written consent of the copyright owner.

All products and companies mentioned are trademarks or registered trademarks of their respective companies.

Disclaimer

Devices sold by austriamicrosystems AG are covered by the warranty and patent indemnification provisions appearing in its Term of Sale. austriamicrosystems AG makes no warranty, express, statutory, implied, or by description regarding the information set forth herein or regarding the freedom of the described devices from patent infringement.

austriamicrosystems AG reserves the right to change specifications and prices at any time and without notice.

Therefore, prior to designing this product into a system, it is necessary to check with austriamicrosystems AG for current information. This product is intended for use in normal commercial applications. Applications requiring extended temperature range, unusual environmental requirements, or high reliability applications, such as military, medical life-support or life-sustaining equipment are specifically not recommended without additional processing by austriamicrosystems AG for each application. For shipments of less than 100 parts the manufacturing flow might show deviations from the standard production flow, such as test flow or test location.

The information furnished here by austriamicrosystems AG is believed to be correct and accurate. However, austriamicrosystems AG shall not be liable to recipient or any third party for any damages, including but not limited to personal injury, property damage, loss of profits, loss of use, interruption of business or indirect, special, incidental or consequential damages, of any kind, in connection with or arising out of the furnishing, performance or use of the technical data herein. No obligation or liability to recipient or any third party shall arise or flow out of austriamicrosystems AG rendering of technical or other services.



Contact Information

Headquarters

austriamicrosystems AG

Tobelbaderstrasse 30

A-8141 Unterpremstaetten - Graz, Austria

Tel: +43 (0) 3136 500 0

Fax: +43 (0) 3136 525 01

For Sales Offices, Distributors and Representatives, please visit:

<http://www.austriamicrosystems.com/contact-us>