

## LP38843

# 3A Ultra Low Dropout Linear Regulators Stable with Ceramic Output Capacitors

### General Description

The LP38843 is a high-current, fast-response regulator which can maintain output voltage regulation with minimum input to output voltage drop. Fabricated on a CMOS process, the device operates from two input voltages: V<sub>bias</sub> provides voltage to drive the gate of the N-MOS power transistor, while V<sub>in</sub> is the input voltage which supplies power to the load. The use of an external bias rail allows the part to operate from ultra low V<sub>in</sub> voltages. Unlike bipolar regulators, the CMOS architecture consumes extremely low quiescent current at any output load current. The use of an N-MOS power transistor results in wide bandwidth, yet minimum external capacitance is required to maintain loop stability.

The fast transient response of these devices makes them suitable for use in powering DSP, Microcontroller Core voltages and Switch Mode Power Supply post regulators. The parts are available in TO-220 and TO-263 packages.

**Dropout Voltage:** 210 mV (typ) @ 3A load current.

**Quiescent Current:** 30 mA (typ) at full load.

**Shutdown Current:** 30 nA (typ) when S/D pin is low.

**Precision Output Voltage:** 1.5% room temperature accuracy.

### Features

- Ideal for conversion from 1.8V or 1.5V inputs
- Designed for use with low ESR ceramic capacitors
- 0.8V, 1.2V and 1.5V standard voltages available
- Ultra low dropout voltage (210mV @ 3A typ)
- 1.5% initial output accuracy
- Load regulation of 0.1%/A (typical)
- 30nA quiescent current in shutdown (typical)
- Low ground pin current at all loads
- Over temperature/over current protection
- Available in 5 lead TO220 and TO263 packages
- -40°C to +125°C junction temperature range

### Applications

- ASIC Power Supplies In:
  - Desktops, Notebooks, and Graphics Cards, Servers
  - Gaming Set Top Boxes, Printers and Copiers
- Server Core and I/O Supplies
- DSP and FPGA Power Supplies
- SMPS Post-Regulator

### Typical Application Circuit

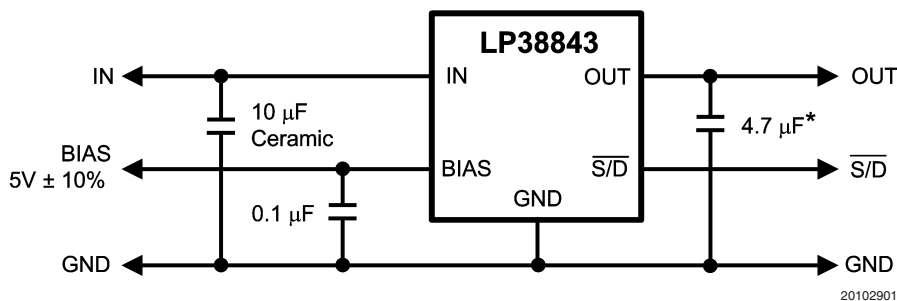

\* Minimum value required if Tantalum capacitor is used (see Application Hints).

20102901

## Connection Diagrams

请向"LP38843S-0.8"供应商

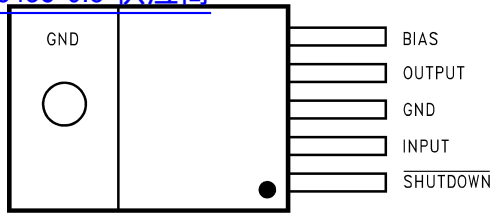

TO-220, Top View

20102902

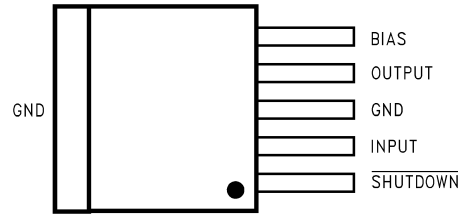

TO-263, Top View

20102903

## Pin Description

Pin Name	Description
BIAS	The bias pin is used to provide the low current bias voltage to the chip which operates the internal circuitry and provides drive voltage for the N-FET.
OUTPUT	The regulated output voltage is connected to this pin.
GND	This is both the power and analog ground for the IC. Note that both pin three and the tab of the TO-220 and TO-263 packages are at ground potential. Pin three and the tab should be tied together using the PC board copper trace material and connected to circuit ground.
INPUT	The high current input voltage which is regulated down to the nominal output voltage must be connected to this pin. Because the bias voltage to operate the chip is provided separately, the input voltage can be as low as a few hundred millivolts above the output voltage.
SHUTDOWN	This provides a low power shutdown function which turns the regulated output OFF. Tie to $V_{BIAS}$ if this function is not used.

## Ordering Information

Order Number	Package Type	Package Drawing	Supplied As
LP38843S-0.8	TO263-5	TS5B	Rail
LP38843SX-0.8	TO263-5	TS5B	Tape and Reel
LP38843T-0.8	TO220-5	T05D	Rail
LP38843S-1.2	TO263-5	TS5B	Rail
LP38843SX-1.2	TO263-5	TS5B	Tape and Reel
LP38843T-1.2	TO220-5	T05D	Rail
LP38843S-1.5	TO263-5	TS5B	Rail
LP38843SX-1.5	TO263-5	TS5B	Tape and Reel
LP38843T-1.5	TO220-5	T05D	Rail

### Block Diagram

[查询"LP38843S-0.8"供应商](#)

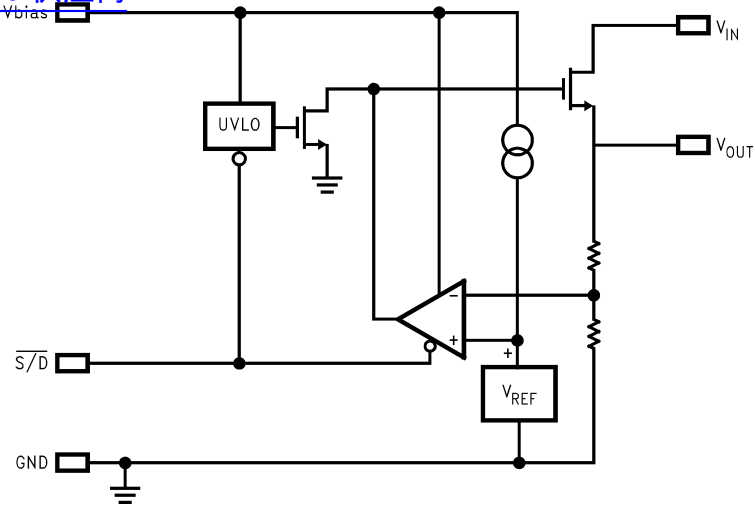

20102924

### Absolute Maximum Ratings (Note 1)

If Military/Aerospace Specified devices are required, please contact the National Semiconductor Sales Office/Distributors for availability and specifications.

Storage Temperature Range	-65°C to +150°C
Lead Temp. (Soldering, 5 seconds)	260°C
ESD Rating	
Human Body Model (Note 3)	2 kV
Machine Model (Note 9)	200V
Power Dissipation (Note 2)	Internally Limited
V <sub>IN</sub> Supply Voltage (Survival)	-0.3V to +6V
V <sub>BIAS</sub> Supply Voltage (Survival)	-0.3V to +7V
Shutdown Input Voltage (Survival)	-0.3V to +7V

I <sub>OUT</sub> (Survival)	Internally Limited
Output Voltage (Survival)	-0.3V to +6V
Junction Temperature	-40°C to +150°C

### Operating Ratings

V <sub>IN</sub> Supply Voltage	(V <sub>OUT</sub> + V <sub>DO</sub> ) to 5.5V
Shutdown Input Voltage	0 to +5.5V
I <sub>OUT</sub>	3A
Operating Junction Temperature Range	-40°C to +125°C
V <sub>BIAS</sub> Supply Voltage	4.5V to 5.5V
V <sub>OUT</sub>	0.8V to 1.5V

**Electrical Characteristics** Limits in standard typeface are for T<sub>J</sub> = 25°C, and limits in **boldface type** apply over the full operating temperature range. Unless otherwise specified: V<sub>IN</sub> = V<sub>O(NOM)</sub> + 1V, V<sub>BIAS</sub> = 4.5V, I<sub>L</sub> = 10 mA, C<sub>IN</sub> = 10 μF CER, C<sub>OUT</sub> = 22 μF CER, C<sub>BIAS</sub> = 1 μF CER, V<sub>S/D</sub> = V<sub>BIAS</sub>. Min/Max limits are guaranteed through testing, statistical correlation, or design.

Symbol	Parameter	Conditions	MIN	TYP (Note 4)	MAX	Units
V <sub>O</sub>	Output Voltage Tolerance	10 mA < I <sub>L</sub> < 3A V <sub>O(NOM)</sub> + 1V ≤ V <sub>IN</sub> ≤ 5.5V 4.5V ≤ V <sub>BIAS</sub> ≤ 5.5V	0.788	0.8	0.812	V
			<b>0.776</b>		<b>0.824</b>	
			1.182	1.2	1.218	
			<b>1.164</b>		<b>1.236</b>	
			1.478	1.5	1.523	
			<b>1.455</b>		<b>1.545</b>	
ΔV <sub>O</sub> /ΔV <sub>IN</sub>	Output Voltage Line Regulation (Note 6)	V <sub>O(NOM)</sub> + 1V ≤ V <sub>IN</sub> ≤ 5.5V		0.01		%/V
ΔV <sub>O</sub> /ΔI <sub>L</sub>	Output Voltage Load Regulation (Note 7)	10 mA < I <sub>L</sub> < 3A		0.1	0.4	%/A
				<b>0.6</b>		
V <sub>DO</sub>	Dropout Voltage (Note 8)	I <sub>L</sub> = 3A		210	270	mV
				<b>500</b>		
I <sub>Q</sub> (V <sub>IN</sub> )	Quiescent Current Drawn from V <sub>IN</sub> Supply	10 mA < I <sub>L</sub> < 3A		30	35	mA
					<b>40</b>	
		V <sub>S/D</sub> ≤ 0.3V		0.06	1	μA
					<b>30</b>	
I <sub>Q</sub> (V <sub>BIAS</sub> )	Quiescent Current Drawn from V <sub>BIAS</sub> Supply	10 mA < I <sub>L</sub> < 3A		2	4	mA
					<b>6</b>	
		V <sub>S/D</sub> ≤ 0.3V		0.03	1	μA
					<b>30</b>	
I <sub>SC</sub>	Short-Circuit Current	V <sub>OUT</sub> = 0V		8		A
<b>Shutdown Input</b>						
V <sub>SDT</sub>	Output Turn-off Threshold	Output = ON		0.7	<b>1.3</b>	V
		Output = OFF	<b>0.3</b>	0.7		
Td (OFF)	Turn-OFF Delay	R <sub>LOAD</sub> X C <sub>OUT</sub> << Td (OFF)		20		μs
Td (ON)	Turn-ON Delay	R <sub>LOAD</sub> X C <sub>OUT</sub> << Td (ON)		15		
I <sub>S/D</sub>	S/D Input Current	V <sub>S/D</sub> = 1.3V		1		μA
		V <sub>S/D</sub> ≤ 0.3V		-1		
θ <sub>J-A</sub>	Junction to Ambient Thermal Resistance	TO-220, No Heatsink		65		°C/W
		TO-263, 1 sq.in Copper		35		

**Electrical Characteristics**

Limits in standard typeface are for  $T_J = 25^\circ\text{C}$ , and limits in **boldface type** apply over the full operating temperature range. Unless otherwise specified:  $V_{IN} = V_O(\text{NOM}) + 1\text{V}$ ,  $V_{BIAS} = 4.5\text{V}$ ,  $I_L = 10\text{ mA}$ ,  $C_{IN} = 10\text{ }\mu\text{F CER}$ ,  $C_{OUT} = 22\text{ }\mu\text{F CER}$ ,  $C_{BIAS} = 1\text{ }\mu\text{F CER}$ ,  $V_{S/D} = V_{BIAS}$ . Min/Max limits are guaranteed through testing, statistical correlation, or design. (Continued)

Symbol	Parameter	Conditions	MIN	TYP (Note 4)	MAX	Units
<b>AC Parameters</b>						
PSRR ( $V_{IN}$ )	Ripple Rejection for $V_{IN}$ Input Voltage	$V_{IN} = V_{OUT} + 1\text{V}$ , $f = 120\text{ Hz}$		80		dB
		$V_{IN} = V_{OUT} + 1\text{V}$ , $f = 1\text{ kHz}$		65		
PSRR ( $V_{BIAS}$ )	Ripple Rejection for $V_{BIAS}$ Voltage	$V_{BIAS} = V_{OUT} + 3\text{V}$ , $f = 120\text{ Hz}$		58		dB
		$V_{BIAS} = V_{OUT} + 3\text{V}$ , $f = 1\text{ kHz}$		58		
	Output Noise Density	$f = 120\text{ Hz}$		1		$\mu\text{V}/\text{root-Hz}$
$e_n$	Output Noise Voltage $V_{OUT} = 1.5\text{V}$	$\text{BW} = 10\text{ Hz} - 100\text{ kHz}$		150		$\mu\text{V (rms)}$
		$\text{BW} = 300\text{ Hz} - 300\text{ kHz}$		90		

**Note 1:** Absolute maximum ratings indicate limits beyond which damage to the component may occur. Operating ratings indicate conditions for which the device is intended to be functional, but do not guarantee specific performance limits. For guaranteed specifications, see Electrical Characteristics. Specifications do not apply when operating the device outside of its rated operating conditions.

**Note 2:** At elevated temperatures, device power dissipation must be derated based on package thermal resistance and heatsink thermal values.  $\theta_{JA}$  for TO-220 devices is  $65^\circ\text{C/W}$  if no heatsink is used. If the TO-220 device is attached to a heatsink, a  $\theta_{JS}$  value of  $4^\circ\text{C/W}$  can be assumed.  $\theta_{JA}$  for TO-263 devices is approximately  $35^\circ\text{C/W}$  if soldered down to a copper plane which is at least 1 square inches in area. If power dissipation causes the junction temperature to exceed specified limits, the device will go into thermal shutdown.

**Note 3:** The human body model is a 100 pF capacitor discharged through a 1.5k resistor into each pin.

**Note 4:** Typical numbers represent the most likely parametric norm for  $25^\circ\text{C}$  operation.

**Note 5:** If used in a dual-supply system where the regulator load is returned to a negative supply, the output pin must be diode clamped to ground.

**Note 6:** Output voltage line regulation is defined as the change in output voltage from nominal value resulting from a change in input voltage.

**Note 7:** Output voltage load regulation is defined as the change in output voltage from nominal value as the load current increases from no load to full load.

**Note 8:** Dropout voltage is defined as the minimum input to output differential required to maintain the output with 2% of nominal value.

**Note 9:** The machine model is a 220 pF capacitor discharged directly into each pin.

# Typical Performance Characteristics

Unless otherwise specified:  $T_J = 25^\circ\text{C}$ ,  $C_{IN} = 10\ \mu\text{F CER}$ ,

$C_{OUT} = 4.7\ \mu\text{F CER}$ ,  $I_L = 10\ \text{mA}$ ,  $V_{BIAS} = 5\ \text{V}$ ,  $V_{IN} = V_{OUT} + 1\ \text{V}$ .

**$V_{BIAS}$  Transient Response**

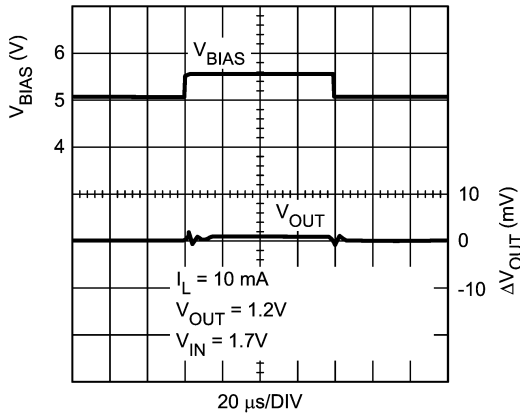

20102936

**Load Transient Response**

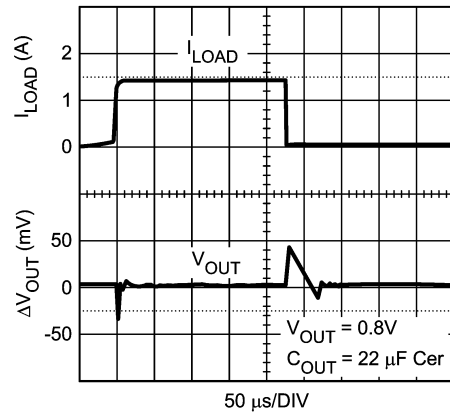

20102937

**Load Transient Response**

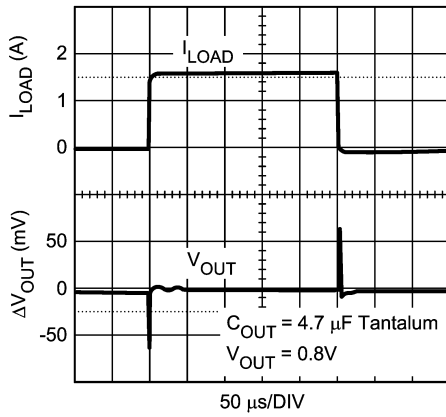

20102938

**Dropout Voltage Over Temperature**

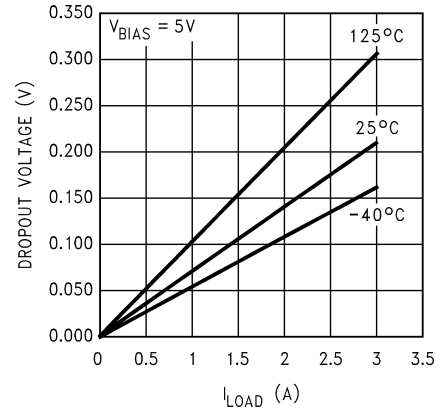

20102939

**$V_{OUT}$  vs Temperature**

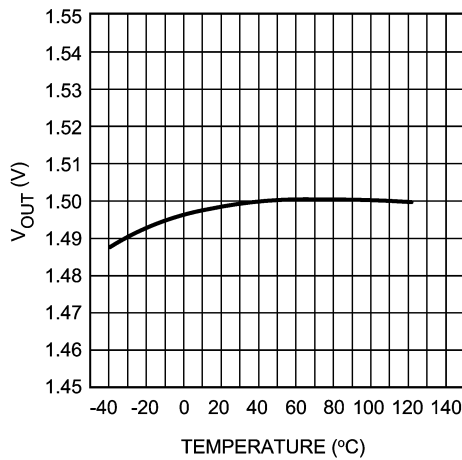

20102940

**$V_{BIAS}$  PSRR**

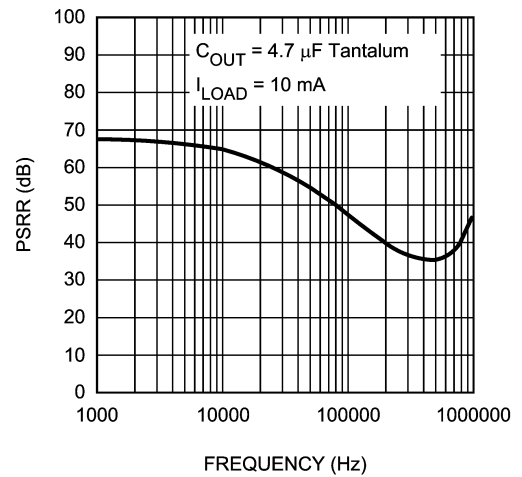

20102941

# Typical Performance Characteristics

Unless otherwise specified:  $T_J = 25^\circ\text{C}$ ,  $C_{IN} = 10\ \mu\text{F CER}$ ,  $C_{OUT} = 2\ \mu\text{F CER}$ ,  $V_{BIAS} = 5\text{V}$ , Pin is tied to  $V_{BIAS}$ ,  $V_{OUT} = 1.2\text{V}$ ,  $I_L = 10\text{mA}$ ,  $V_{BIAS} = 5\text{V}$ ,  $V_{IN} = V_{OUT} + 1\text{V}$ . (Continued)

[查询LP38843-0.6 供应商](#)

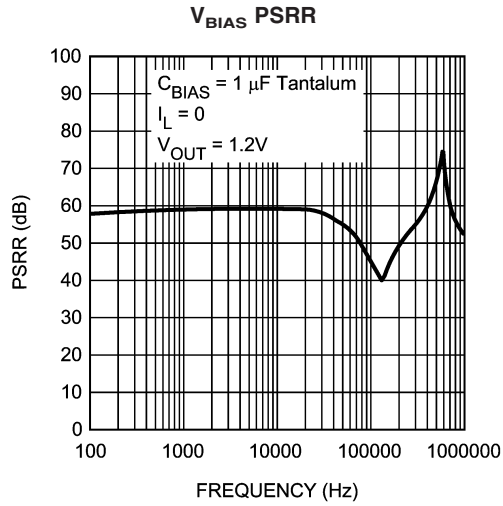

20102951

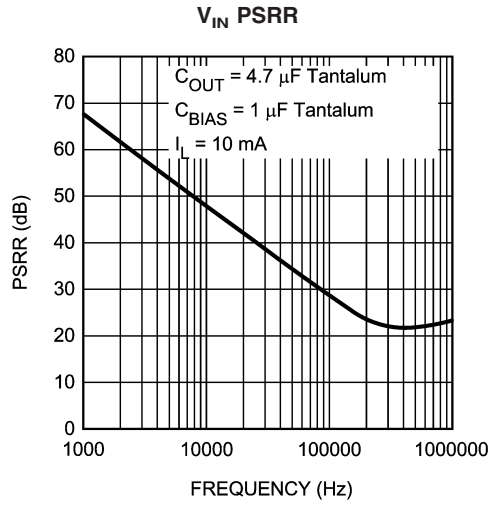

20102942

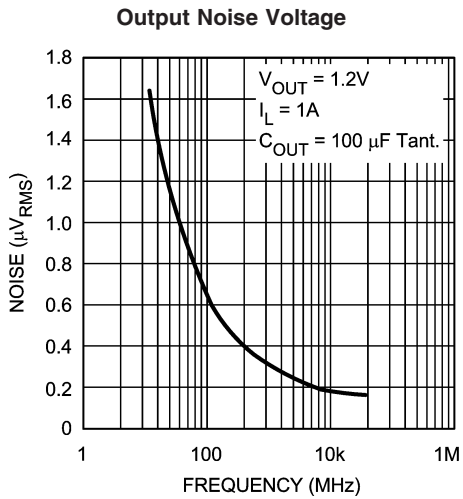

20102943

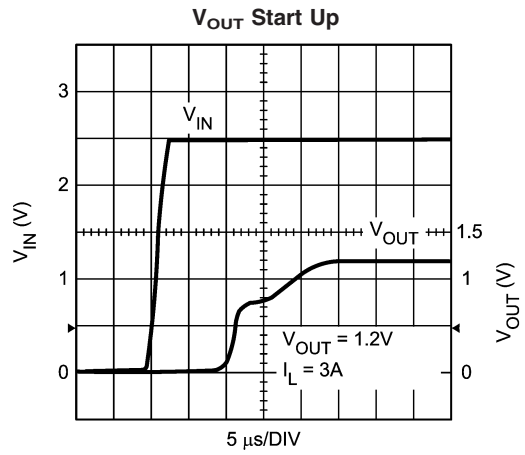

20102950

## Application Hints

查询"LP38843S-0.8"供应商

### EXTERNAL CAPACITORS

To assure regulator stability, input and output capacitors are required as shown in the Typical Application Circuit.

### OUTPUT CAPACITOR

An output capacitor is required on the LP3884X devices for loop stability. The minimum value of capacitance necessary depends on type of capacitor: if a solid Tantalum capacitor is used, the part is stable with capacitor values as low as 4.7 $\mu$ F. If a ceramic capacitor is used, a minimum of 22  $\mu$ F of capacitance must be used (capacitance may be increased without limit). The reason a larger ceramic capacitor is required is that the output capacitor sets a pole which limits the loop bandwidth. The Tantalum capacitor has a higher ESR than the ceramic which provides more phase margin to the loop, thereby allowing the use of a smaller output capacitor because adequate phase margin can be maintained out to a higher crossover frequency. The tantalum capacitor will typically also provide faster settling time on the output after a fast changing load transient occurs, but the ceramic capacitor is superior for bypassing high frequency noise.

The output capacitor must be located less than one centimeter from the output pin and returned to a clean analog ground. Care must be taken in choosing the output capacitor to ensure that sufficient capacitance is provided over the full operating temperature range. If ceramics are selected, only X7R or X5R types may be used because Z5U and Y5F types suffer severe loss of capacitance with temperature and applied voltage and may only provide 20% of their rated capacitance in operation.

### INPUT CAPACITOR

The input capacitor is also critical to loop stability because it provides a low source impedance for the regulator. The minimum required input capacitance is 10  $\mu$ F ceramic (Tantalum not recommended). The value of  $C_{IN}$  may be increased without limit. As stated above, X5R or X7R must be used to ensure sufficient capacitance is provided. The input capacitor must be located less than one centimeter from the input pin and returned to a clean analog ground.

### BIAS CAPACITOR

The 0.1 $\mu$ F capacitor on the bias line can be any good quality capacitor (ceramic is recommended).

### BIAS VOLTAGE

The bias voltage is an external voltage rail required to get gate drive for the N-FET pass transistor. Bias voltage must be in the range of 4.5 - 5.5V to assure proper operation of the part.

### UNDER VOLTAGE LOCKOUT

The bias voltage is monitored by a circuit which prevents the regulator output from turning on if the bias voltage is below approximately 4V.

### SHUTDOWN OPERATION

Pulling down the shutdown ( $\overline{S/D}$ ) pin will turn-off the regulator. Pin  $\overline{S/D}$  must be actively terminated through a pull-up resistor (10 k $\Omega$  to 100 k $\Omega$ ) for a proper operation. If this pin is driven from a source that actively pulls high and low (such as a CMOS rail to rail comparator), the pull-up resistor is not required. This pin must be tied to  $V_{BIAS}$  if not used.

### POWER DISSIPATION/HEATSINKING

A heatsink may be required depending on the maximum power dissipation and maximum ambient temperature of the application. Under all possible conditions, the junction temperature must be within the range specified under operating conditions. The total power dissipation of the device is given by:

$$P_D = (V_{IN} - V_{OUT})I_{OUT} + (V_{IN})I_{GND}$$

where  $I_{GND}$  is the operating ground current of the device.

The maximum allowable temperature rise ( $T_{Rmax}$ ) depends on the maximum ambient temperature ( $T_{Amax}$ ) of the application, and the maximum allowable junction temperature ( $T_{Jmax}$ ):

$$T_{Rmax} = T_{Jmax} - T_{Amax}$$

The maximum allowable value for junction to ambient Thermal Resistance,  $\theta_{JA}$ , can be calculated using the formula:

$$\theta_{JA} = T_{Rmax} / P_D$$

These parts are available in TO-220 and TO-263 packages. The thermal resistance depends on amount of copper area or heat sink, and on air flow. If the maximum allowable value of  $\theta_{JA}$  calculated above is  $\geq 60$   $^{\circ}$ C/W for TO-220 package and  $\geq 60$   $^{\circ}$ C/W for TO-263 package no heatsink is needed since the package can dissipate enough heat to satisfy these requirements. If the value for allowable  $\theta_{JA}$  falls below these limits, a heat sink is required.

### HEATSINKING TO-220 PACKAGE

The thermal resistance of a TO220 package can be reduced by attaching it to a heat sink or a copper plane on a PC board. If a copper plane is to be used, the values of  $\theta_{JA}$  will be same as shown in next section for TO263 package.

The heatsink to be used in the application should have a heatsink to ambient thermal resistance,

$$\theta_{HA} \leq \theta_{JA} - \theta_{CH} - \theta_{JC}$$

In this equation,  $\theta_{CH}$  is the thermal resistance from the case to the surface of the heat sink and  $\theta_{JC}$  is the thermal resistance from the junction to the surface of the case.  $\theta_{JC}$  is about 3 $^{\circ}$ C/W for a TO220 package. The value for  $\theta_{CH}$  depends on method of attachment, insulator, etc.  $\theta_{CH}$  varies between 1.5 $^{\circ}$ C/W to 2.5 $^{\circ}$ C/W. If the exact value is unknown, 2 $^{\circ}$ C/W can be assumed.

### HEATSINKING TO-263 PACKAGE

The TO-263 package uses the copper plane on the PCB as a heatsink. The tab of this package is soldered to the copper plane for heat sinking. The graph below shows a curve for the  $\theta_{JA}$  of TO-263 package for different copper area sizes, using a typical PCB with 1 ounce copper and no solder mask over the copper area for heat sinking.



**Application Hints** (Continued)

[查询"LP38843S-0.8"供应商](#)

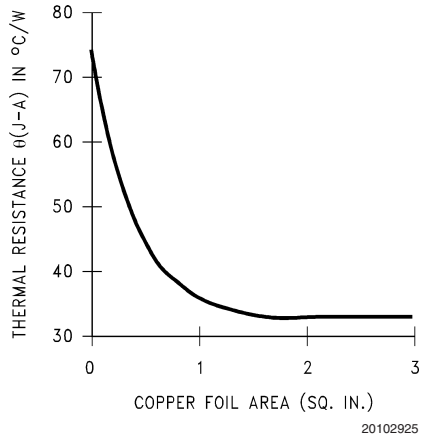

**FIGURE 1.  $\theta_{JA}$  vs Copper (1 Ounce) Area for TO-263 package**

As shown in the graph below, increasing the copper area beyond 1 square inch produces very little improvement. The minimum value for  $\theta_{JA}$  for the TO-263 package mounted to a PCB is 32°C/W.

Figure 2 shows the maximum allowable power dissipation for TO-263 packages for different ambient temperatures, assuming  $\theta_{JA}$  is 35°C/W and the maximum junction temperature is 125°C.

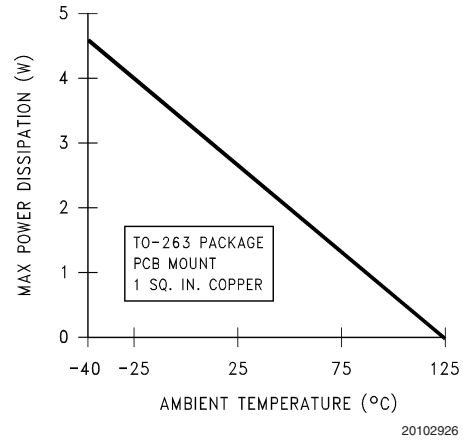
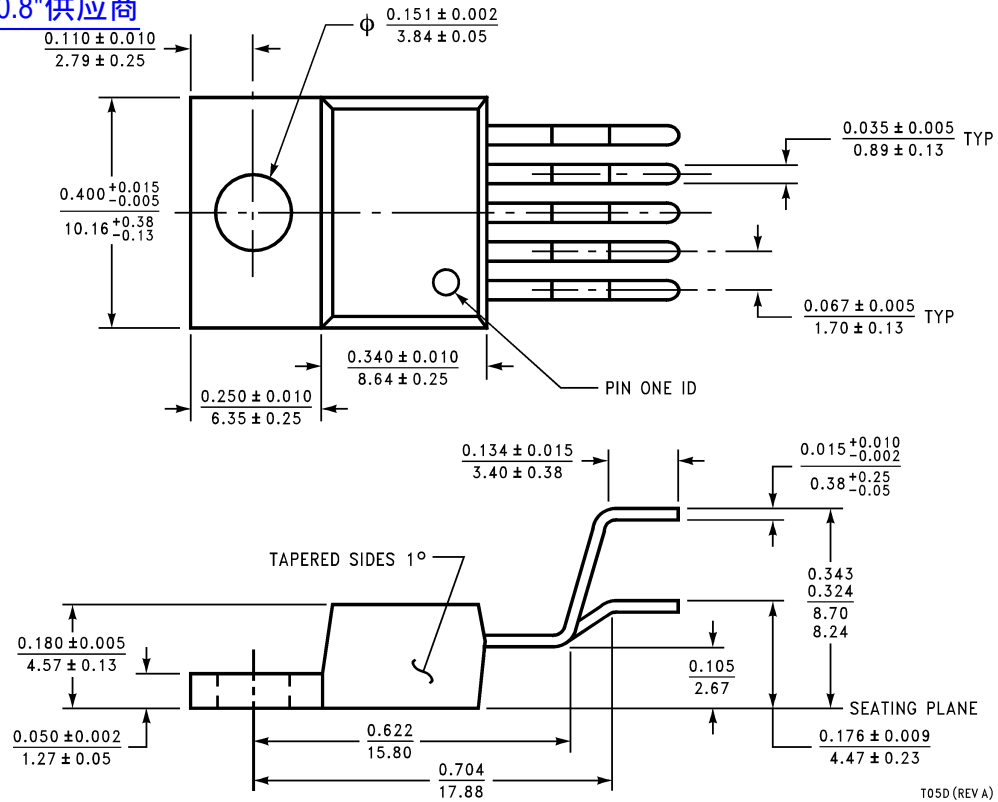

**FIGURE 2. Maximum power dissipation vs ambient temperature for TO-263 package**

# Physical Dimensions

inches (millimeters) unless otherwise noted

请向"LP38843S-0.8"供应商



T05D (REV A)

**TO220 5-lead, Molded, Stagger Bend Package (TO220-5)  
NS Package Number T05D**

**Physical Dimensions** inches (millimeters) unless otherwise noted (Continued)

[查询"LP38843S-0.8"供应商](#)

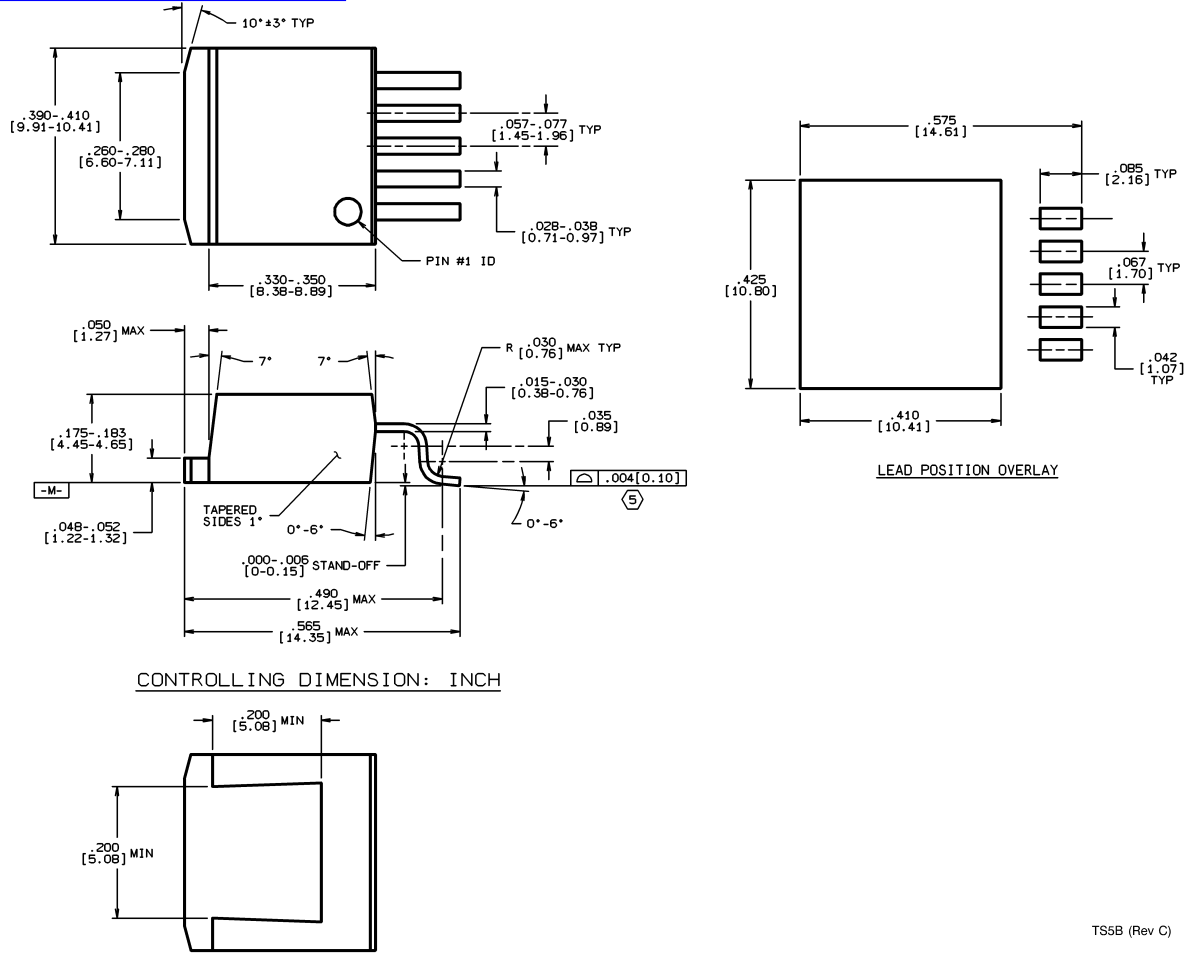

**TO263 5-Lead, Molded, Surface Mount Package (TO263-5)**  
**NS Package Number TS5B**

National does not assume any responsibility for use of any circuitry described, no circuit patent licenses are implied and National reserves the right at any time without notice to change said circuitry and specifications.

For the most current product information visit us at [www.national.com](http://www.national.com).

**LIFE SUPPORT POLICY**

NATIONAL'S PRODUCTS ARE NOT AUTHORIZED FOR USE AS CRITICAL COMPONENTS IN LIFE SUPPORT DEVICES OR SYSTEMS WITHOUT THE EXPRESS WRITTEN APPROVAL OF THE PRESIDENT AND GENERAL COUNSEL OF NATIONAL SEMICONDUCTOR CORPORATION. As used herein:

1. Life support devices or systems are devices or systems which, (a) are intended for surgical implant into the body, or (b) support or sustain life, and whose failure to perform when properly used in accordance with instructions for use provided in the labeling, can be reasonably expected to result in a significant injury to the user.
2. A critical component is any component of a life support device or system whose failure to perform can be reasonably expected to cause the failure of the life support device or system, or to affect its safety or effectiveness.

**BANNED SUBSTANCE COMPLIANCE**

National Semiconductor certifies that the products and packing materials meet the provisions of the Customer Products Stewardship Specification (CSP-9-111C2) and the Banned Substances and Materials of Interest Specification (CSP-9-111S2) and contain no "Banned Substances" as defined in CSP-9-111S2.

**National Semiconductor**  
**Americas Customer**  
**Support Center**  
 Email: [new.feedback@nsc.com](mailto:new.feedback@nsc.com)  
 Tel: 1-800-272-9959

**National Semiconductor**  
**Europe Customer Support Center**  
 Fax: +49 (0) 180-530 85 86  
 Email: [europe.support@nsc.com](mailto:europe.support@nsc.com)  
 Deutsch Tel: +49 (0) 69 9508 6208  
 English Tel: +44 (0) 870 24 0 2171  
 Français Tel: +33 (0) 1 41 91 8790

**National Semiconductor**  
**Asia Pacific Customer**  
**Support Center**  
 Email: [ap.support@nsc.com](mailto:ap.support@nsc.com)

**National Semiconductor**  
**Japan Customer Support Center**  
 Fax: 81-3-5639-7507  
 Email: [jpn.feedback@nsc.com](mailto:jpn.feedback@nsc.com)  
 Tel: 81-3-5639-7560