

1. Features

- IF bandpass filter
- Low-Loss Filter
- Single-ended operation
- Ceramic Surface Mount Device(SMD) Package
- Maximum Storage Temperature Range : -40℃ ~ 85℃
- Electrostatics Sensitive Device (ESD)

2. Package Dimension

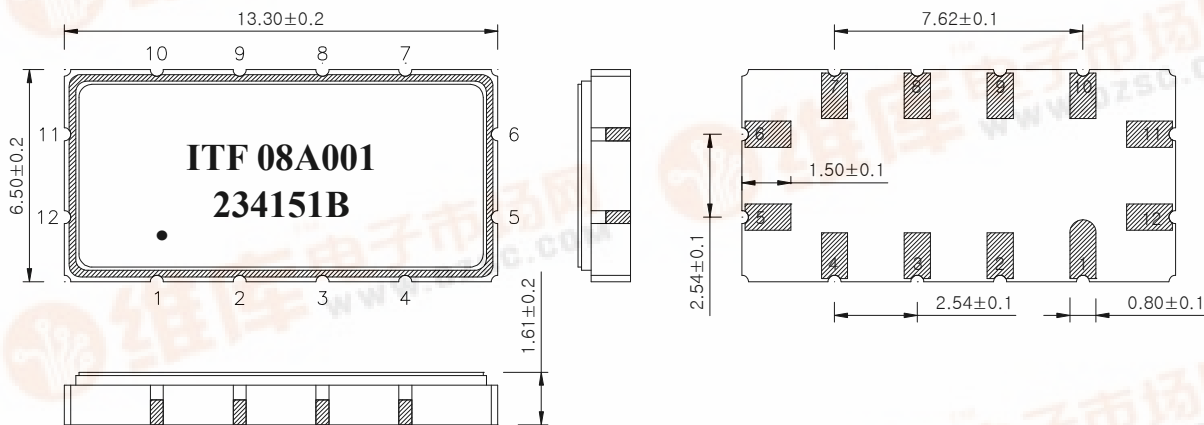

Package : S1365

Dimensions shown are nominal in millimeters

Body : Al₂O₃

Lid : Kovar, Ni Plated

Termination : Au plating 0.3 ~ 1.0um, over a 1.27 ~ 8.89um Ni Plating

Pin Configuration	
11	Input
5	Output
6, 12	Ground
Other	Case ground

	ITF Co., Ltd. 102-901, Bucheon Technopark 364, Samjeong-Dong, Ojeong-Gu, Bucheon-City, Gyeonggi-Do, Korea 421-809	Part No.	234151B	
		Rev. Date	2008-09-24	
		Rev.	NJ8018-AS01	1/5



3. Specifications

F₀ = 75.0 MHz

Terminating source impedance : 50Ω and matching network

Terminating load impedance : 50Ω and matching network

Room temperature : +25°C		Minimum	Typical	Maximum
Center Frequency (Fc)	MHz	-	75.0	-
Insertion Loss	dB	-	21.1	23.0
1dB Bandwidth	MHz	-	40.52	-
3dB Bandwidth	MHz	41.2	41.6	-
40dB Bandwidth	MHz	-	46.25	46.7
Amplitude Ripple (F ₀ +/- 19.42 MHz)	dB	-	0.5	1.0
Group Delay Variation (F ₀ +/- 19.42 MHz)	nsec	-	25	50
Absolute Delay	usec	-	1.0	-
Relative Attenuation				
94.42 MHz + 3.0 MHz	dB	15	19	-
94.42 MHz + 5.0 MHz	dB	50	55	-
5.0 MHz ~ 49.0 MHz	dB	50	55	-
49.0 MHz ~ 51.5 MHz	dB	40	45	-
100.0 MHz ~ 112.5 MHz	dB	45	50	-
112.5 MHz ~ 138.0 MHz	dB	36	40	-
138.0 MHz ~ 145.0 MHz	dB	40	45	-
Temperature Coefficient of Frequency (TCF)	ppm/°C	-	- 86	-

Notes :

- 1) All specifications are based on the matching schematic shown below
- 2) All specifications are measured by Agilent Network analyzer and full 2 port calibration
- 3) Electrical margin has been built into the design to account for the variations due to temperature drift and manufacturing tolerances
- 4) All attenuation measurements are measured relative to insertion loss

	ITF Co., Ltd. 102-901, Bucheon Technopark 364, Samjeong-Dong, Ojeong-Gu, Bucheon-City, Gyeonggi-Do, Korea 421-809	Part No.	234151B	
		Rev. Date	2008-09-24	
		Rev.	NJ8018-AS01	2/5

4. Matching Schematic

(Actual matching values may vary due to PCB layout and parasitics)

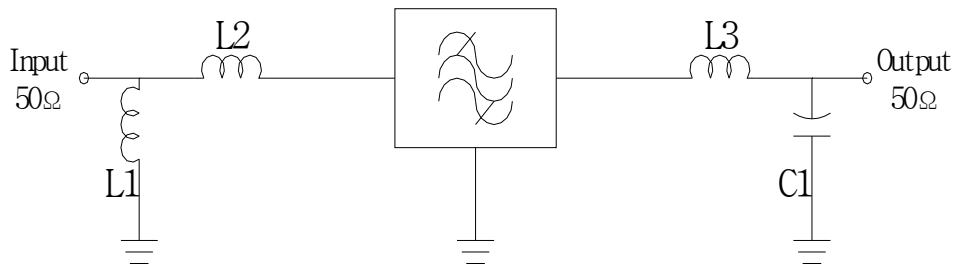

L1 = 120 nH, L2 = 18 nH
 L3 = 150 nH, C1 = 27 pF

5. Marking Configuration

ITF¹⁾ 08A001²⁾

234151B³⁾

●⁴⁾

1) Manufacturer name

2) Lot Number

3) Part Number

4) Pad Number 1 Index

	ITF Co., Ltd. 102-901, Bucheon Technopark 364, Samjeong-Dong, Ojeong-Gu, Bucheon-City, Gyeonggi-Do, Korea 421-809	Part No.	234151B	
		Rev. Date	2008-09-24	
		Rev.	NJ8018-AS01	3/5

6. Typical Performance (at +25°C)

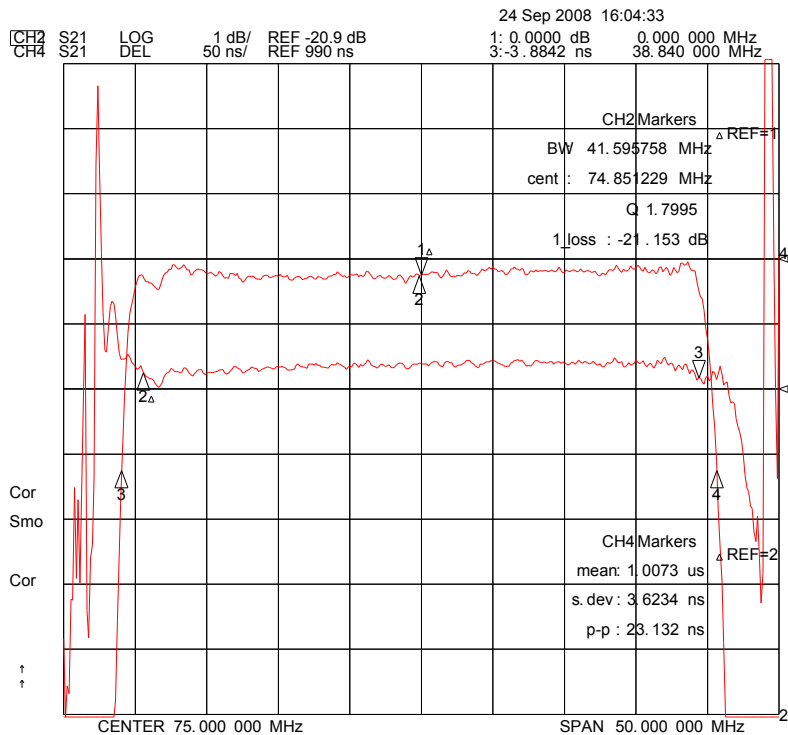
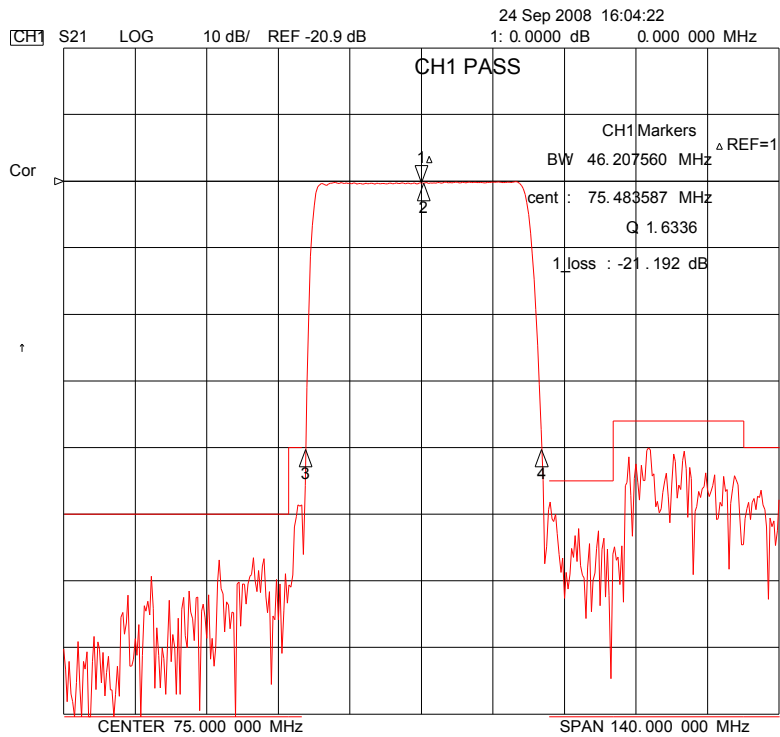

	ITF Co., Ltd. 102-901, Bucheon Technopark 364, Samjeong-Dong, Ojeong-Gu, Bucheon-City, Gyeonggi-Do, Korea 421-809	Part No.	234151B	
		Rev. Date	2008-09-24	
		Rev.	NJ8018-AS01	4/5

Bandpass Filter 234151B

查询234151B供应商

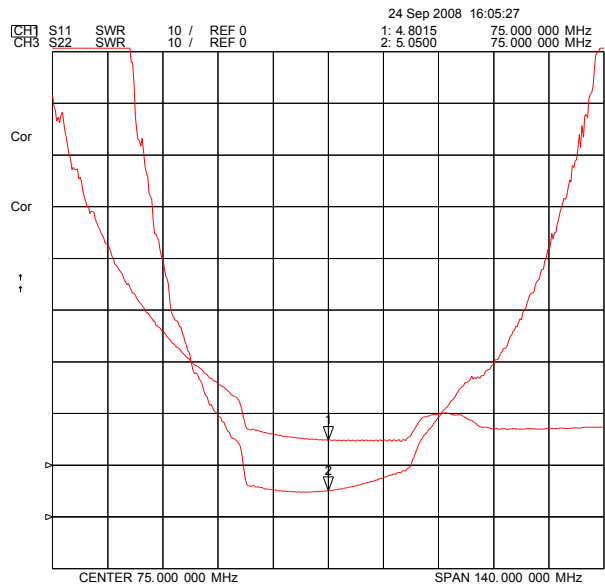
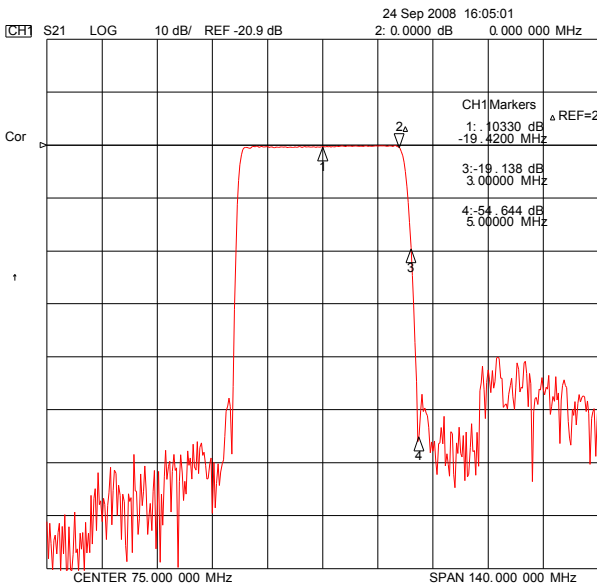
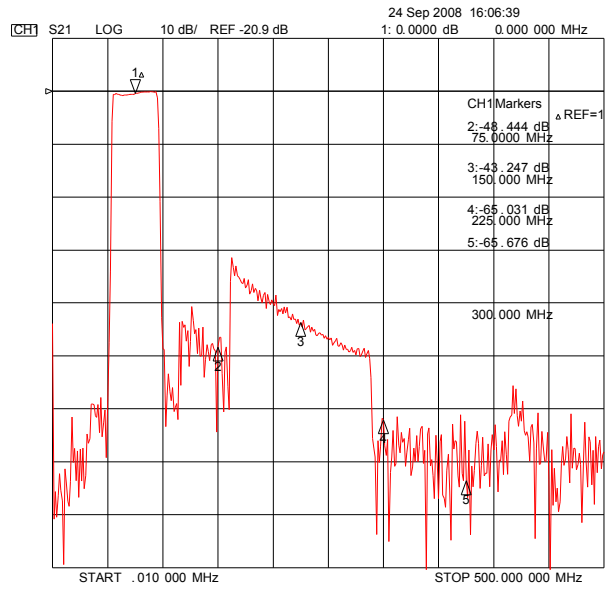
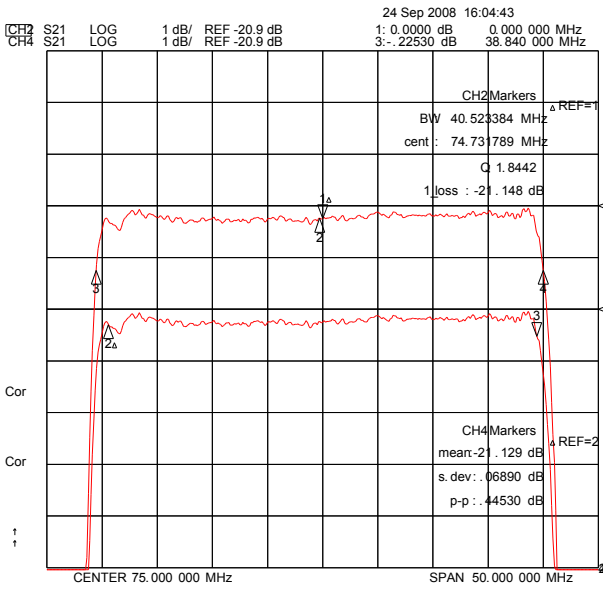

ITF Co., Ltd.
 102-901, Bucheon Technopark 364,
 Samjeong-Dong, Ojeong-Gu, Bucheon-City,
 Gyeonggi-Do, Korea 421-809

Part No.	234151B	
Rev. Date	2008-09-24	
Rev.	NJ8018-AS01	5/5