



Aluminum electrolytic capacitors

Alu-X product lines

4-pin snap-in capacitors



Series/Type: B41201, B43201
Date: April 2008



© EPCOS AG 2008. Reproduction, publication and dissemination of this publication and the information contained therein without EPCOS' prior express consent is prohibited.



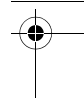

4-pin snap-in capacitors
Standard series – 85 °C

B41201, B43201

General-purpose grade capacitors

Applications

- Professional switch-mode power supplies

Features

- High ripple current capability
- RoHS-compatible
- Load life of 2000 h at 85 °C

Construction

- Aluminum case, fully insulated
- Charge/discharge-proof
- Minus pole marking on the insulating sleeve
- Case with safety vent

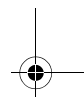
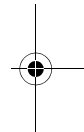

Please read *Cautions and warnings* and *Important notes* at the end of this document.





4-pin snap-in capacitors

B41201, B43201

Standard series – 85 °C

Specifications and characteristics in brief

Rated voltage V_R	10 ... 500 V DC												
Operating temperature range	$V_R \leq 250$ V DC: -40 °C ... $+85$ °C $V_R \geq 315$ V DC: -25 °C ... $+85$ °C												
Rated capacitance C_R (20 °C, 120 Hz)	100 ... 68000 μ F												
Capacitance tolerance	$\pm 20\% \triangleq M$												
Load life (85 °C, V_R , $I_{AC,R}$)	2000 h Requirements: $\Delta C/C \leq \pm 20\%$ of initial value $\tan \delta \leq 2$ times initial specified limit $I_{leak} \leq$ initial specified limit												
Leakage current I_{leak} (20 °C, after 5 minutes)	$I_{leak} \leq 0.02 \mu A \cdot \left(\frac{C_R}{\mu F} \cdot \frac{V_R}{V} \right)$												
Dissipation factor (max.) (20 °C, 120 Hz)	V_R (V DC)	10	16	25	35	50	63	80	100	160 ... 200	250 ... 400	450 ... 500	
	$\tan \delta$	0.50	0.50	0.40	0.40	0.30	0.25	0.20	0.15	0.12	0.15	0.20	
Low temperature stability (impedance ratio) (120 Hz)	V_R (V DC)	10			16 ... 160			200 ... 250			315 ... 400		450 ... 500
	$\frac{Z(-25 \text{ °C})}{Z(+20 \text{ °C})}$	5			4			7			8		8
	$\frac{Z(-40 \text{ °C})}{Z(+20 \text{ °C})}$	18			15			12			–		–
Shelf life	After storage for 1000 h at 85 °C, the capacitors shall meet the requirement of load life test after reforming process. After test: V_R to be applied for 30 minutes, 24 to 48 hours before measurement.												
Frequency multiplier for rated ripple current		50 Hz		120 Hz		1 kHz		10 kHz		20 kHz			
	≤ 50 V	0.95		1.00		1.10		1.15		1.15			
	63 ... 100 V	0.95		1.00		1.16		1.30		1.33			
	≥ 160 V	0.90		1.00		1.20		1.50		1.55			
Temperature multiplier for rated ripple current		+40 °C		+55 °C		+70 °C		+85 °C					
	< 160 V	2.1		2.1		1.5		1.0					
	≥ 160 V	1.7		1.5		1.3		1.0					



4-pin snap-in capacitors
Standard series – 85 °C

B41201, B43201

Dimensional drawing

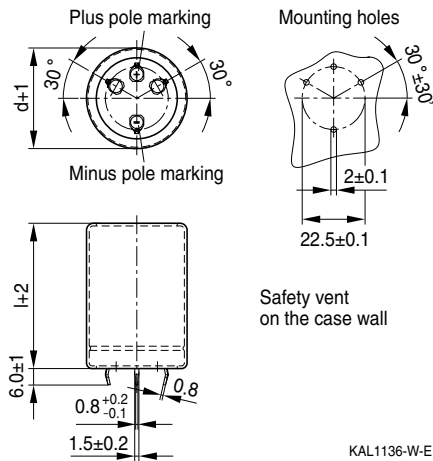

Overview of available types B41201

V_R (V DC)	10	16	25	35
	Case dimensions $d \times l$ (mm)			
C_R (μF)				
12000				35 × 30
15000				35 × 35
18000				35 × 40
22000			35 × 30	35 × 45
27000		35 × 25	35 × 35	
33000	35 × 25	35 × 30	35 × 40	
39000	35 × 30	35 × 35	35 × 45	
47000	35 × 30	35 × 40		
56000	35 × 35	35 × 45		
68000	35 × 40	35 × 50		

Please read *Cautions and warnings* and *Important notes* at the end of this document.



4-pin snap-in capacitors

B41201, B43201

Standard series – 85 °C

Overview of available types B41201

V_R (V DC)	50	63	80	100
	Case dimensions d × l (mm)			
C_R (μF)				
2700				35 × 30
3300				35 × 35
3900				35 × 35
4700	35 × 25	35 × 30	35 × 30	35 × 40
5600	35 × 25	35 × 30	35 × 35	35 × 45
6800	35 × 30	35 × 30	35 × 40	
8200	35 × 30	35 × 35	35 × 45	
10000	35 × 35	35 × 40		
12000	35 × 40	35 × 45		
15000	35 × 45			
18000	35 × 50			

Overview of available types B43201

V_R (V DC)	160	200	250	315
	Case dimensions d × l (mm)			
C_R (μF)				
180				35 × 20
220				35 × 20
270				35 × 25
330			35 × 20	35 × 30
390		35 × 20	35 × 20	35 × 30
470		35 × 20	35 × 25	35 × 35
560	35 × 20	35 × 20	35 × 25	35 × 40
680	35 × 20	35 × 25	35 × 30	35 × 45
820	35 × 25	35 × 30	35 × 35	35 × 50
1000	35 × 25	35 × 30	35 × 40	
1200	35 × 30	35 × 35	35 × 45	
1500	35 × 35	35 × 40	35 × 50	
1800	35 × 40	35 × 45		

Please read *Cautions and warnings* and *Important notes* at the end of this document.



4-pin snap-in capacitors
Standard series – 85 °C

B41201, B43201

Overview of available types B43201

V_R (V DC)	350	400	450	500
	Case dimensions $d \times l$ (mm)			
C_R (μF)				
100			35 × 20	
120			35 × 20	
150		35 × 20	35 × 25	
180	35 × 20	35 × 25	35 × 25	
220	35 × 35	35 × 25	35 × 30	
270	35 × 25	35 × 30	35 × 35	35 × 45
330	35 × 30	35 × 30	35 × 40	35 × 50
390	35 × 35	35 × 35	35 × 45	
470	35 × 40	35 × 40	35 × 50	
560	35 × 45	35 × 45		
680	35 × 50			

Please read *Cautions and warnings* and *Important notes* at the end of this document.



4-pin snap-in capacitors

B41201, B43201

Standard series – 85 °C

Technical data and ordering codes B41201

V _R V DC	C _R 120 Hz 20 °C μF	Case dimensions d × l mm	I _{AC,R} 120 Hz 85 °C A	Ordering code
10	33000	35 × 25	5.81	B41201D3339M000
	39000	35 × 30	6.38	B41201C3399M000
	47000	35 × 30	6.62	B41201C3479M000
	56000	35 × 35	7.18	B41201B3569M000
	68000	35 × 40	7.76	B41201A3689M000
16	27000	35 × 25	5.80	B41201C4279M000
	33000	35 × 30	6.41	B41201B4339M000
	39000	35 × 35	6.96	B41201B4399M000
	47000	35 × 40	7.54	B41201B4479M000
	56000	35 × 45	8.08	B41201A4569M000
	68000	35 × 50	8.63	B41201A4689M000
25	22000	35 × 30	5.51	B41201B5229M000
	27000	35 × 35	6.12	B41201B5279M000
	33000	35 × 40	6.74	B41201B5339M000
	39000	35 × 45	7.35	B41201A5399M000
35	12000	35 × 30	5.24	B41201B7129M000
	15000	35 × 35	5.88	B41201B7159M000
	18000	35 × 40	6.46	B41201B7189M000
	22000	35 × 45	7.07	B41201A7229M000
50	4700	35 × 25	4.19	B41201D6478M000
	5600	35 × 25	4.44	B41201D6568M000
	6800	35 × 30	5.04	B41201D6688M000
	8200	35 × 30	5.26	B41201C6828M000
	10000	35 × 35	5.97	B41201B6109M000
	12000	35 × 40	6.55	B41201B6129M000
	15000	35 × 45	7.20	B41201A6159M000
	18000	35 × 50	7.74	B41201A6189M000
63	4700	35 × 30	4.19	B41201D8478M000
	5600	35 × 30	4.70	B41201C8568M000
	6800	35 × 30	5.04	B41201C8688M000
	8200	35 × 35	5.53	B41201B8828M000
	10000	35 × 40	6.25	B41201B8109M000
	12000	35 × 45	6.83	B41201A8129M000



4-pin snap-in capacitors
Standard series – 85 °C

B41201, B43201

Technical data and ordering codes B41201

V_R V DC	C_R 120 Hz 20 °C μF	Case dimensions $d \times l$ mm	$I_{AC,R}$ 120 Hz 85 °C A	Ordering code
80	4700	35 × 30	5.27	B41201C0478M000
	5600	35 × 35	5.81	B41201B0568M000
	6800	35 × 40	5.46	B41201A0688M000
	8200	35 × 45	6.91	B41201A0828M000
100	2700	35 × 30	4.37	B41201C9278M000
	3300	35 × 35	4.85	B41201C9338M000
	3900	35 × 35	5.27	B41201B9398M000
	4700	35 × 40	5.80	B41201B9478M000
	5600	35 × 45	6.34	B41201A9568M000

Please read *Cautions and warnings* and *Important notes* at the end of this document.



4-pin snap-in capacitors

B41201, B43201

Standard series – 85 °C

Technical data and ordering codes B43201

V _R V DC	C _R 120 Hz 20 °C μF	Case dimensions d × l mm	I _{AC,R} 120 Hz 85 °C A	Ordering code
160	560	35 × 20	2.12	B43201D1567M000
	680	35 × 20	2.33	B43201D1687M000
	820	35 × 25	2.73	B43201D1827M000
	1000	35 × 25	3.01	B43201D1108M000
	1200	35 × 30	3.26	B43201C1128M000
	1500	35 × 35	3.83	B43201B1158M000
	1800	35 × 40	4.39	B43201A1188M000
200	390	35 × 20	1.77	B43201D2397M000
	470	35 × 20	1.94	B43201D2477M000
	560	35 × 20	2.25	B43201D2567M000
	680	35 × 25	2.48	B43201D2687M000
	820	35 × 30	2.88	B43201D2827M000
	1000	35 × 30	3.18	B43201B2108M000
	1200	35 × 35	3.43	B43201B2128M000
	1500	35 × 40	4.01	B43201B2158M000
	1800	35 × 45	4.58	B43201A2188M000
250	330	35 × 20	1.62	B43201I2337M000
	390	35 × 20	1.77	B43201I2397M000
	470	35 × 25	2.06	B43201I2477M000
	560	35 × 25	2.25	B43201I2567M000
	680	35 × 30	2.62	B43201H2687M000
	820	35 × 35	3.03	B43201G2827M000
	1000	35 × 40	3.50	B43201G2108M000
	1200	35 × 45	3.74	B43201F2128M000
	1500	35 × 50	4.35	B43201F2158M000
315	180	35 × 20	1.20	B43201D0187M000
	220	35 × 20	1.33	B43201D0227M000
	270	35 × 25	1.56	B43201D0277M000
	330	35 × 30	1.83	B43201D0337M000
	390	35 × 30	1.99	B43201C0397M000
	470	35 × 35	2.29	B43201B0477M000
	560	35 × 40	2.62	B43201A0567M000
	680	35 × 45	3.01	B43201A0687M000
	820	35 × 50	3.44	B43201A0827M000



4-pin snap-in capacitors

B41201, B43201

Standard series – 85 °C

Technical data and ordering codes B43201

V _R V DC	C _R 120 Hz 20 °C μF	Case dimensions d × l mm	I _{AC,R} 120 Hz 85 °C A	Ordering code
350	180	35 × 20	1.20	B43201D4187M000
	220	35 × 35	1.41	B43201D4227M000
	270	35 × 25	1.65	B43201C4277M000
	330	35 × 30	1.83	B43201C4337M000
	390	35 × 35	2.09	B43201B4397M000
	470	35 × 40	2.40	B43201B4477M000
	560	35 × 45	2.73	B43201A4567M000
	680	35 × 50	3.13	B43201A4687M000
400	150	35 × 20	1.09	B43201D9157M000
	180	35 × 25	1.28	B43201D9187M000
	220	35 × 25	1.41	B43201D9227M000
	270	35 × 30	1.65	B43201C9277M000
	330	35 × 30	1.83	B43201C9337M000
	390	35 × 35	2.09	B43201B9397M000
	470	35 × 40	2.40	B43201B9477M000
	560	35 × 45	2.73	B43201A9567M000
450	100	35 × 20	0.68	B43201D5107M000
	120	35 × 20	0.75	B43201D5127M000
	150	35 × 25	0.89	B43201D5157M000
	180	35 × 25	0.98	B43201C5187M000
	220	35 × 30	1.14	B43201C5227M000
	270	35 × 35	1.33	B43201B5277M000
	330	35 × 40	1.54	B43201B5337M000
	390	35 × 45	1.74	B43201A5397M000
	470	35 × 50	1.99	B43201A5477M000
500	270	35 × 45	1.45	B43201A6277M000
	330	35 × 50	1.66	B43201A6337M000

Please read *Cautions and warnings* and *Important notes* at the end of this document.



Cautions and warnings

General

Also see "Important notes" on page 13.

- 1 Aluminum electrolytic capacitors have a bi-polar structure. This is marked on the body of the capacitor. A capacitor must not be mounted with reversed polarity. The application of an AC or reverse voltage may cause a short circuit or damage the capacitor. Bi-polar capacitors must not be used in AC applications, where the polarity may be reversed in the circuits or is unknown.
- 2 The DC voltage applied to the capacitor terminal must not exceed its rated operating voltage, as this will result in a rapid increase of the leakage current and may damage the capacitor. It is recommended to operate the capacitor at 70–80% of its rated voltage to optimize its service life.
- 3 The ripple current applied to the capacitor must be within the permitted range. An excessive ripple current leads to impaired electrical properties and may damage the capacitor. Note that the sum of the peak values of the ripple voltage and the DC operating voltage must not exceed the rated DC voltage.
- 4 Capacitors must be used within their permitted range of operating temperature. Operation at room temperature optimizes their service life.
- 5 Capacitors with case diameter ≥ 8 mm are equipped with a safety vent. In capacitors fitted with a lead or soldering lug, the safety vent is usually located at the base of the case. It needs sufficient space around it to operate optimally. The following dimensions are recommended: for case diameter $d = 8$ to 16 mm, more than 2 mm; for $d = 18$ to 35 mm, more than 3 mm; and for $d = 42$ mm or more, more than 5 mm.
- 6 Capacitors should not be mounted with the safety vent face down on the board. Do not locate any wire or copper trace near the safety vent. Do not reverse the voltage, as this may result in excess pressure and the leakage of electrolyte.
- 7 Gas is released through the safety vent when the pressure inside the capacitor is too high. A gaseous liquid around the safety vent does not indicate a leakage of electrolyte.
- 8 The capacitor should be stored under conditions of normal temperature and in a non-acid, non-alkali environment of normal humidity. Exposure to high temperatures, for example under direct sunlight, will reduce its operating life. If the capacitor is stored in an environment containing acids or alkalis, the solderability of the leads may be affected.
- 9 The leakage current of an aluminum electrolytic capacitor may increase after a long period of storage. After such storage, the capacitor must be aged by applying the rated operating voltage for 6–8 hours before use.
- 10 Manual soldering:
 - a Soldering must be performed within the specified conditions.
Bit temperature: 350 °C; application time of soldering iron: 3 seconds.
 - b Ensure that the soldering iron does not touch any part of the capacitor body.

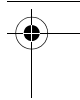
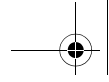

Cautions and warnings

- 11 Do not apply excessive force to the leads and terminals. Do not move the capacitor after soldering it onto the PC board and do not carry the PC board by gripping the capacitor. Observe the following rules to prevent undue stress to the capacitor:
 - a Do not tilt or bend the capacitor after soldering.
 - b Ensure that the terminal spacing matches the corresponding hole spacing on the PC board.
- 12 The aluminum case is not insulated from the cathode. Do not place a conductor under the aluminum capacitors on the PC board as this may cause a short circuit. The case and top of capacitors used in switched mode power supplies have a high-voltage-resistant heat shrink sleeve to ensure safe usage.
- 13 The leads of capacitors with a case diameter exceeding 14 mm cannot be used for fixing.

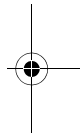
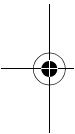

Please read *Cautions and warnings* and *Important notes* at the end of this document.

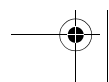
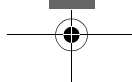



Important notes

The following applies to all products named in this publication:

1. Some parts of this publication contain **statements about the suitability of our products for certain areas of application**. These statements are based on our knowledge of typical requirements that are often placed on our products in the areas of application concerned. We nevertheless expressly point out **that such statements cannot be regarded as binding statements about the suitability of our products for a particular customer application**. As a rule, EPCOS is either unfamiliar with individual customer applications or less familiar with them than the customers themselves. For these reasons, it is always ultimately incumbent on the customer to check and decide whether an EPCOS product with the properties described in the product specification is suitable for use in a particular customer application.
2. We also point out that **in individual cases, a malfunction of electronic components or failure before the end of their usual service life cannot be completely ruled out in the current state of the art, even if they are operated as specified**. In customer applications requiring a very high level of operational safety and especially in customer applications in which the malfunction or failure of an electronic component could endanger human life or health (e.g. in accident prevention or life-saving systems), it must therefore be ensured by means of suitable design of the customer application or other action taken by the customer (e.g. installation of protective circuitry or redundancy) that no injury or damage is sustained by third parties in the event of malfunction or failure of an electronic component.
3. **The warnings, cautions and product-specific notes must be observed.**
4. In order to satisfy certain technical requirements, **some of the products described in this publication may contain substances subject to restrictions in certain jurisdictions (e.g. because they are classed as hazardous)**. Useful information on this will be found in our Material Data Sheets on the Internet (www.epcos.com/material). Should you have any more detailed questions, please contact our sales offices.
5. We constantly strive to improve our products. Consequently, **the products described in this publication may change from time to time**. The same is true of the corresponding product specifications. Please check therefore to what extent product descriptions and specifications contained in this publication are still applicable before or when you place an order.
We also **reserve the right to discontinue production and delivery of products**. Consequently, we cannot guarantee that all products named in this publication will always be available. The aforementioned does not apply in case of individual agreements deviating from the foregoing for customer-specific products.
6. Unless otherwise agreed in individual contracts, **all orders are subject to the current version of the "General Terms of Delivery for Products and Services in the Electrical Industry" published by the German Electrical and Electronics Industry Association (ZVEI)**.
7. The trade names EPCOS, BAOKE, Alu-X, CeraDiode, CSSP, CTVS, DSSP, MiniBlue, MKK, MLSC, MotorCap, PCC, PhaseCap, PhaseMod, SIFERRIT, SIFI, SIKOREL, SilverCap, SIMDAD, SIMID, SineFormer, SIOV, SIP5D, SIP5K, ThermoFuse, WindCap are **trademarks registered or pending** in Europe and in other countries. Further information will be found on the Internet at www.epcos.com/trademarks.