

LM22673 Evaluation Board

[查询LM22673供应商](#)

National Semiconductor
Application Note 1894
Frederik Dostal
September 16, 2010



Introduction

The LM22673 evaluation board is designed to demonstrate the capabilities of the LM22673 switching regulator. The LM22673 evaluation board schematic shown in [Figure 1](#) is configured to provide an output voltage of 3.3V up to 3A load current with an input voltage range of 4.5V to 42V. Due to the low $R_{DS(ON)}$ of the integrated N-channel MOSFET and maximum duty-cycle limitations, the minimum input voltage of 4.5V will only provide a 3.3V output voltage for load currents up to 500 mA. For load currents higher than 500 mA, an input voltage of 5.5V or higher is required. The typical operating frequency is 500 kHz. The evaluation board is designed to operate at ambient temperatures up to 50°C.

The performance of the evaluation board is as follows:

Input Range: 4.5V to 42V

Output Voltage: 3.3V

Output Current Range: 0A to 3A

Frequency of Operation: 500 kHz

Board Size: 1.5 X 1.5 inches

Package: PSOP-8

At low input voltages between 4.5V and 6V, a minimum load of approximately 5 mA may be required to reach a regulated 3.3V output voltage. See the LM22673 datasheet for more details.

To aid in the design and evaluation of DC/DC buck converter solutions based on the LM22673 switching regulator, the evaluation board can be re-configured for different output voltages.

The evaluation board is designed to highlight applications with a small solution size. This implies that there will be a tradeoff with the area of heat dissipation available. If this evaluation board is operated continuously at a full 3A load, it will get hot. For higher output voltages than the pre-adjusted 3.3V, the total output power as well as the total power conversion losses will increase. It is recommended to use a fan or other source of air flow when evaluating the board at full 3A load or at output voltages greater than 3.3V. Typical evaluation board performance and characteristics curves are shown in [Figure 2](#) through [Figure 5](#). [Figure 6](#) shows the PCB layout.

Test points are provided to enable easy connection and monitoring of critical signals. When performing over load or short circuit tests, refer to the current limit section of the LM22673 datasheet to determine if the circuit is in safe operating mode. For more information about device function and electrical characteristics, refer to the LM22673 datasheet.

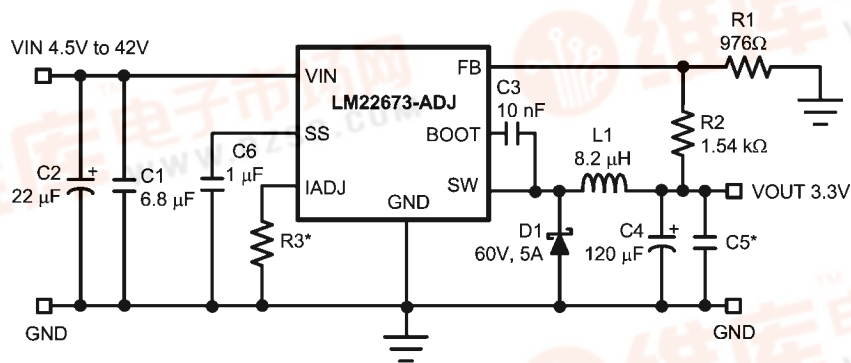

*component not populated on LM22673EVAL evaluation board

30078301

FIGURE 1. Evaluation Board Schematic

Evaluation Board Setup

查询LM22673供应商

Before applying power to the LM22673 evaluation board, all external connections should be verified. The external power supply must be turned off and connected with proper polarity to the VIN and GND posts. A load resistor or electronic load should be connected between the VOUT and GND posts as desired. Both the VIN and VOUT connections should use the closest GND posts respective to VIN or VOUT. The output voltage can be monitored with a multi-meter or oscilloscope at the VOUT post.

Once all connections to the evaluation board have been verified, input power can be applied. A load resistor or electronic load does not require connection during startup. The output voltage will ramp up when an input voltage is applied. Make sure that the external power supply (input voltage power source) is capable of providing enough current so that the adjusted output voltage can be obtained. Keep in mind that the startup current will be greater than the steady state current.

Soft-Start

The capacitor C6 sets the amount of soft-start. A 1 μF soft-start capacitor is used for slow start-up. See the LM22673 datasheet for details about the soft-start function.

Current Limit Adjust

Current limit can be reduced from the nominal LM22673 peak current limit by using a resistor R3. See the LM22673 datasheet for information about the current limit adjust function. R3 is not populated on the evaluation board. This sets the current limit to the nominal current limit as specified in the LM22673 datasheet.

Component Selection

Before changing the default components refer to the LM22673 datasheet for information regarding component selection. The WEBENCH® designer online circuit simulation tool is also available at www.national.com.

The output voltage is adjustable with resistors R1 and R2 shown in the schematic. Any changes to these evaluation board feedback resistors may require changes to the inductor and output capacitor values. It is especially important to change the output capacitor, C4, if the output voltages are adjusted higher than 5V. The Schottky diode, D1, has a voltage rating of 60V to allow for a 42V maximum input voltage. If the input voltage is below 38V, a 40V Schottky diode may be used with a lower forward voltage to improve efficiency. For improved heat dissipation, a Schottky diode in a D2PAK package may be selected for higher efficiency. The input capacitor, C2, is not always required. This capacitor is placed on the evaluation board to make the application robust and minimize input voltage ringing if power is suddenly applied. Capacitor C2 also helps stabilize the transfer function of the converter loop. The input capacitor C1 provides the main contribution to the switch current. Both capacitors are selected with appropriate values intended only for the evaluation of the LM22673. For production designs, the impedance of the power source as well as the ripple current rating of the selected input capacitors need to be taken into consideration and modified accordingly. See the LM22673 datasheet for more information.

Output capacitor C5 is not populated but space is provided to add a second output capacitor. This second output capacitor may be used to further reduce output voltage ripple.

TABLE 1. LM22673EVAL Bill of Materials for VOUT = 3.3V, Designed for 3A Output Current

Ref #	Value	Supplier	Part Number
C1	6.8 μF 50V ceramic	TDK	C4532X7R1H685M
C2	22 μF 63V electrolytic	Panasonic	EEEFK1J220XP
C3	10 nF 50V ceramic	TDK	C1608X7R1H103K
C4	120 μF 6.3V 24mohm	Nippon Chemi-Con	APXE6R3ARA121ME61G
C5	Not populated	-	
C6	1 μF 10V ceramic	TDK	C1608Y5V1A105Z
D1	60V 5A CMSH5-60	Central Semiconductor	CMSH5-60
L1	8.2 μH 6.25A WE-PD L	Wurth	744771008
		Coilcraft	MSS1260-822MX
R1	976 Ω 1%	-	CRCW0603976RFKEA
R2	1.54 k Ω 1%	-	CRCW06031K54FKEA
R3	Not populated	-	
U1		National Semiconductor	LM22673MR-ADJ

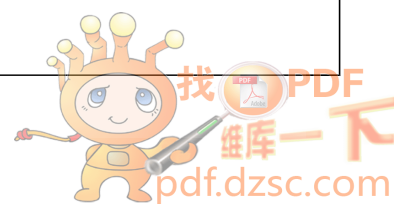

Performance Characteristics

查询LM22673供应商

Unless otherwise specified, $V_{IN} = 12V$, $T_A = 25^\circ C$.

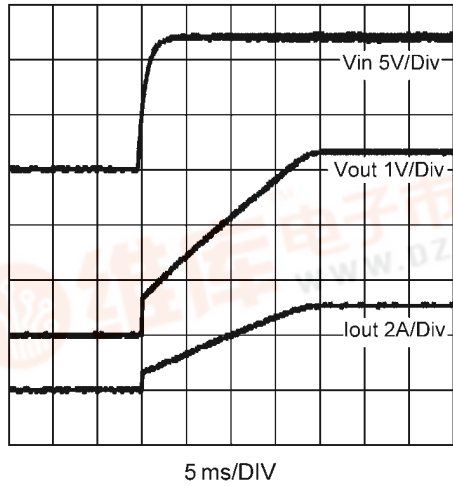

30078305

FIGURE 2. Start-Up Waveforms
(Load Resistor = 1.1Ω)

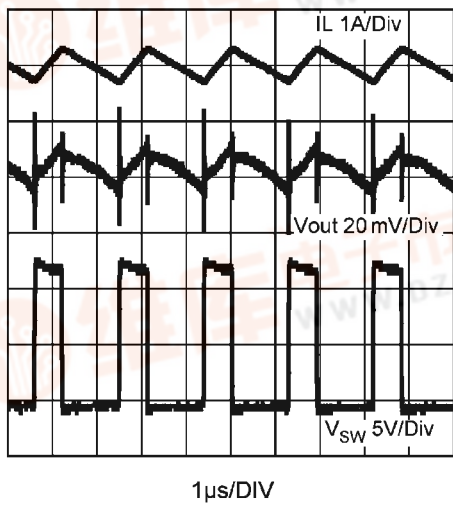

30078302

FIGURE 3. Operation at 3A

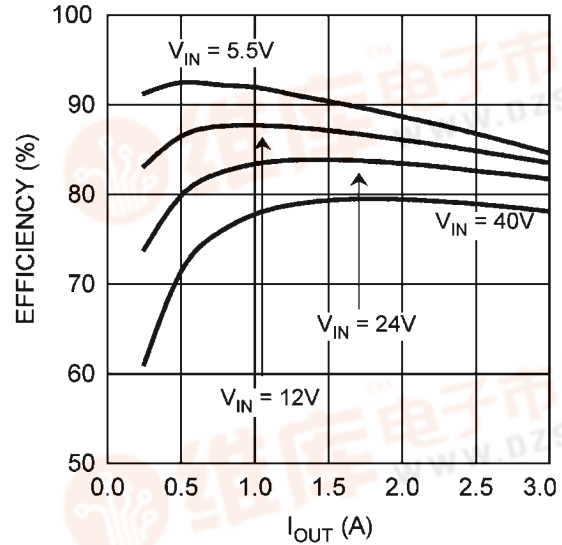

30078303

FIGURE 4. Efficiency vs I_{OUT}

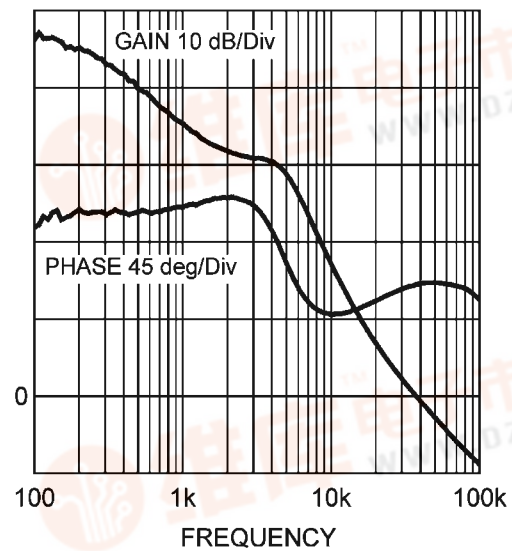

30078304

FIGURE 5. Overall Loop Gain and Phase ($I_{OUT} = 3A$)

PCB Layout Diagram

[查询LM22673供应商](#)

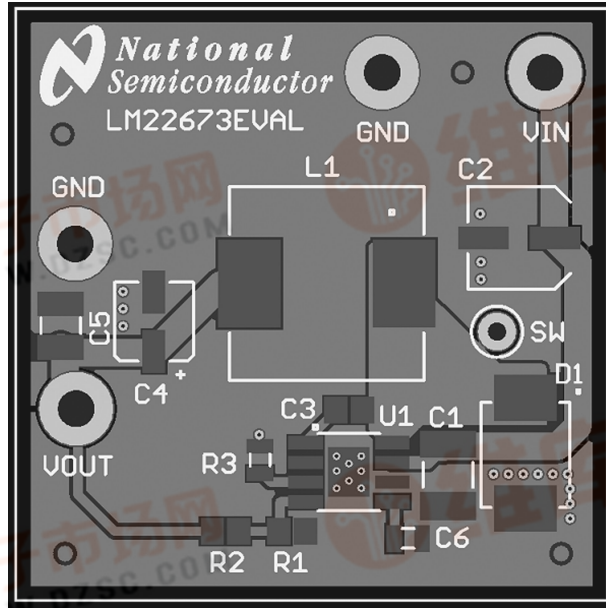

30078306

FIGURE 6. Top Layer



[查询LM22673供应商](#)

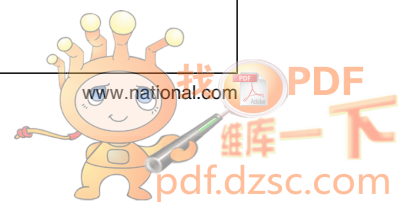

[查询LM22673供应商](#)

Notes

For more National Semiconductor product information and proven design tools, visit the following Web sites at:
www.national.com

Products		Design Support	
Amplifiers	www.national.com/amplifiers	WEBENCH® Tools	www.national.com/webench
Audio	www.national.com/audio	App Notes	www.national.com/appnotes
Clock and Timing	www.national.com/timing	Reference Designs	www.national.com/refdesigns
Data Converters	www.national.com/adc	Samples	www.national.com/samples
Interface	www.national.com/interface	Eval Boards	www.national.com/evalboards
LVDS	www.national.com/lvds	Packaging	www.national.com/packaging
Power Management	www.national.com/power	Green Compliance	www.national.com/quality/green
Switching Regulators	www.national.com/switchers	Distributors	www.national.com/contacts
LDOs	www.national.com/ldo	Quality and Reliability	www.national.com/quality
LED Lighting	www.national.com/led	Feedback/Support	www.national.com/feedback
Voltage References	www.national.com/vref	Design Made Easy	www.national.com/easy
PowerWise® Solutions	www.national.com/powerwise	Applications & Markets	www.national.com/solutions
Serial Digital Interface (SDI)	www.national.com/sdi	Mil/Aero	www.national.com/milaero
Temperature Sensors	www.national.com/tempensors	SolarMagic™	www.national.com/solarmagic
PLL/VCO	www.national.com/wireless	PowerWise® Design University	www.national.com/training

THE CONTENTS OF THIS DOCUMENT ARE PROVIDED IN CONNECTION WITH NATIONAL SEMICONDUCTOR CORPORATION ("NATIONAL") PRODUCTS. NATIONAL MAKES NO REPRESENTATIONS OR WARRANTIES WITH RESPECT TO THE ACCURACY OR COMPLETENESS OF THE CONTENTS OF THIS PUBLICATION AND RESERVES THE RIGHT TO MAKE CHANGES TO SPECIFICATIONS AND PRODUCT DESCRIPTIONS AT ANY TIME WITHOUT NOTICE. NO LICENSE, WHETHER EXPRESS, IMPLIED, ARISING BY ESTOPPEL OR OTHERWISE, TO ANY INTELLECTUAL PROPERTY RIGHTS IS GRANTED BY THIS DOCUMENT.

TESTING AND OTHER QUALITY CONTROLS ARE USED TO THE EXTENT NATIONAL DEEMS NECESSARY TO SUPPORT NATIONAL'S PRODUCT WARRANTY. EXCEPT WHERE MANDATED BY GOVERNMENT REQUIREMENTS, TESTING OF ALL PARAMETERS OF EACH PRODUCT IS NOT NECESSARILY PERFORMED. NATIONAL ASSUMES NO LIABILITY FOR APPLICATIONS ASSISTANCE OR BUYER PRODUCT DESIGN. BUYERS ARE RESPONSIBLE FOR THEIR PRODUCTS AND APPLICATIONS USING NATIONAL COMPONENTS. PRIOR TO USING OR DISTRIBUTING ANY PRODUCTS THAT INCLUDE NATIONAL COMPONENTS, BUYERS SHOULD PROVIDE ADEQUATE DESIGN, TESTING AND OPERATING SAFEGUARDS.

EXCEPT AS PROVIDED IN NATIONAL'S TERMS AND CONDITIONS OF SALE FOR SUCH PRODUCTS, NATIONAL ASSUMES NO LIABILITY WHATSOEVER, AND NATIONAL DISCLAIMS ANY EXPRESS OR IMPLIED WARRANTY RELATING TO THE SALE AND/OR USE OF NATIONAL PRODUCTS INCLUDING LIABILITY OR WARRANTIES RELATING TO FITNESS FOR A PARTICULAR PURPOSE, MERCHANTABILITY, OR INFRINGEMENT OF ANY PATENT, COPYRIGHT OR OTHER INTELLECTUAL PROPERTY RIGHT.

LIFE SUPPORT POLICY

NATIONAL'S PRODUCTS ARE NOT AUTHORIZED FOR USE AS CRITICAL COMPONENTS IN LIFE SUPPORT DEVICES OR SYSTEMS WITHOUT THE EXPRESS PRIOR WRITTEN APPROVAL OF THE CHIEF EXECUTIVE OFFICER AND GENERAL COUNSEL OF NATIONAL SEMICONDUCTOR CORPORATION. As used herein:

Life support devices or systems are devices which (a) are intended for surgical implant into the body, or (b) support or sustain life and whose failure to perform when properly used in accordance with instructions for use provided in the labeling can be reasonably expected to result in a significant injury to the user. A critical component is any component in a life support device or system whose failure to perform can be reasonably expected to cause the failure of the life support device or system or to affect its safety or effectiveness.

National Semiconductor and the National Semiconductor logo are registered trademarks of National Semiconductor Corporation. All other brand or product names may be trademarks or registered trademarks of their respective holders.

Copyright© 2010 National Semiconductor Corporation

For the most current product information visit us at www.national.com



National Semiconductor
Americas Technical
Support Center
Email: support@nsc.com
Tel: 1-800-272-9959

National Semiconductor Europe
Technical Support Center
Email: europe.support@nsc.com

National Semiconductor Asia
Pacific Technical Support Center
Email: ap.support@nsc.com

National Semiconductor Japan
Technical Support Center
Email: jpn.feedback@nsc.com

